



CATALOGO GENERALE

2024

EDIZIONE N°20

ITALIA € IVA ESCLUSA

ORDINE MINIMO 300€



01	CHIAVI DI MANOVRA	22
02	CHIAVI A BUSSOLA	38
03	GIRAVITI, INSERTI E PINZE	84
04	UTENSILI ISOLATI	112
05	UTENSILI DINAMOMETRICI	128
06	UTENSILI DA PERCUSSIONE	134
07	UTENSILI DA TAGLIO	140
08	ESTRATTORI	154
09	UTENSILI DI MISURAZIONE	164
10	UTENSILI PNEUMATICI	170
11	AUTOMOTIVE	188
12	MANUTENZIONE GENERALE	300
13	UTENSILI PER IDRAULICA	316
14	BORSE DA LAVORO	320
15	CARRELLI E BANCHI DA LAVORO	334
16	ARREDAMENTO TECNICO	384
17	PROFESSIONAL EQUIPMENT	444



Colore, energia, potenza. Ancora di più.

2024

I nuovi utensili professionali Fasano Tools rendono possibile ogni sfida del tuo lavoro quotidiano.

+ LUCE

LAMPADE A LED

Tante soluzioni efficienti che si aggiungono a quelle già a catalogo per offrirti ancora più scelta.

Le nuove LAMPADE Fasano Tools presentano funzioni innovative che rendono semplici le operazioni più complicate.

+ COLORE

CARRELLI BI COLOR

Due colori, ancora più carattere per il tuo carrello porta utensili FG 100 che ora puoi scegliere in base al tuo stile. 14 varianti colore disponibili.



NOVITA'

PRODOTTI E CATEGORIE DI PRODOTTO CHE SI AGGIUNGONO PER ESSERE SEMPRE PRONTI ALLE ESIGENZE DI MERCATO.

+ ORDINE

BORSE PORTA UTENSILI

6 nuovi modelli arricchiscono l'offerta di gamma e ampliano la scelta possibile. Trolley, tracolle, cestelli, borsoni e zaini.

Scegli la borsa porta utensili che preferisci per le tue attività quotidiane in base alle tue esigenze.

+ CARICA

CARICABATTERIE

I nuovi caricabatterie e mantenitori di carica presentano funzioni eccezionali che assicurano un alto grado di efficienza energetica, anche in situazioni particolari.

Ideali per moto, auto ma anche furgoni, imbarcazioni e mezzi pesanti.

+ GAMMA

TRUCK

Tanti nuovi utensili e ricambi per mezzi pesanti.

Scegli gli utensili professionali Fasano Tools per la riparazione e la manutenzione di motore, freni, telaio, assali, ruote e pneumatici di autocarri.



NUOVE BORSE PORTA UTENSILI

CAPIENTI, COMODE E SUPER FUNZIONALI. CON LE NUOVE BORSE PORTA UTENSILI FASANO TOOLS PORTI IL TUO LAVORO OVUNQUE E TUTTO QUELLO CHE TI SERVE È SEMPRE CON TE!

6 NUOVI MODELLI per ogni esigenza lavorativa. **Ampi scomparti separati e tasche multiple, laterali e frontali**, per riporre i tuoi utensili, differenziandone l'utilizzo e riprendere poi ciò che ti serve, senza perdere tempo. Non solo attrezzi! I nostri modelli di borse porta utensili sono ideati per trasportare anche oggetti di uso quotidiano come pc, chiavi, smartphone e tutto il necessario per lavorare fuori dagli ambienti di lavoro.



NEW



TROLLEY, TRACOLLE, CESTELLI, BORSONI E ZAINI

Scegli lo **zaino con gli spallacci imbottiti** per avere le mani libere e conservare documenti e pc portatile. Con lo **zaino provvisto di manico telescopico e ruote** invece, puoi viaggiare anche in aereo e fare lunghi tragitti a piedi, senza fatica.

Prediligi un **cestello con copertura**, se preferisci il connubio tra la classica cassetta porta attrezzi ed un borsoni provvisto di tracolla.

Due **borsoni** con ampi scomparti interni e tasche esterne, ti permettono di separare gli oggetti di uso quotidiano dagli utensili da lavoro.

Puoi scegliere tra una struttura completamente rigida o una semi rigida.

Infine, con il **trolley**, trasporti con facilità utensili elettrici o manuali di peso maggiore, dove vuoi, senza sforzi.

Tutte realizzate in tessuto tecnico, le Borse Porta Utensili Fasano Tools sono la tua soluzione versatile ad ogni esigenza giornaliera. E che stile!



NUOVI UTENSILI PER MANUTENZIONE TRUCK



Scopri i nuovi utensili e ricambi per mezzi pesanti

UNA GAMMA COMPLETA DI UTENSILI SPECIALI PER IL SETTORE TRUCK

Bussole, chiavi, estrattori, prolunghe e molto altro!

I nuovi prodotti che arricchiscono la sezione Automotive coprono un ampio range di applicazioni, poiché si utilizzano sia per la riparazione e la manutenzione del motore, che per quella dei freni, del telaio, degli assali, di ruote e pneumatici di autocarri.

UTENSILI PER FILTRI OLIO

UTENSILI PER ASSALI

UTENSILI PER DADI RUOTA

UTENSILI PER GIUNTI SFERICI

UTENSILI PER MOZZI / COPRIMOZZI

UTENSILI PER DIFFERENZIALI

UTENSILI PER DADI AUTOBLOCCANTI

UTENSILI PER PARAOLI

UTENSILI PER VALVOLE INIEZIONE

UTENSILI PER INIETTORI

UTENSILI PER CUSCINETTI

UTENSILI PER PINZE FRENO

UTENSILI PER ROTAZIONE ALBERO MOTORE

UTENSILI BLOCCAGGIO VOLANO



Gli utensili Fasano Tools dedicati al settore Truck, inoltre, si utilizzano su un vastissimo numero di brand di veicoli presenti sul mercato

DAF FORD IVECO MAN MERCEDES-BENZ RENAULT SCANIA VOLVO BPW SAF

Metti alla prova i nostri nuovi prodotti per mezzi pesanti!



**TSC
SYSTEM**

**TECNOLOGIA DI
SPEGNIMENTO
PER CONTATTO**



AMPIA GAMMA DI LAMPAD E A LED



**FUNZIONI INNOVATIVE
CHE RENDONO SEMPLICI
LE OPERAZIONI PIÙ COMPLICATE.**



**RISPARMIO
ENERGETICO**



**MASSIMA
AUTONOMIA**



**FUNZIONE
POWER BANK**



**TSC
SYSTEM**



**CASSE
WIRELESS**



**GRADO DI
PROTEZIONE
IP65**



CASSE WIRELESS



**GRADO
DI RESISTENZA
AGLI URTI IK 07**





TROVA LA GIUSTA CARICA PER IL TUO LAVORO!

NEW

Con i nuovi **CARICABATTERIE FASANO TOOLS**, l'energia a disposizione non finisce mai.

IDEALI PER MOTO, AUTO, MA ANCHE FURGONI, IMBARCAZIONI E MEZZI PESANTI.



I nostri **CARICABATTERIE** presentano alcune funzioni davvero eccezionali che assicurano **UN ALTO GRADO DI EFFICIENZA ENERGETICA.**

**JUMP
MODE**

**WINTER
MODE**



**BE STRONG. BE POWERFUL. BE BRAVE.
BI COLOR**



MADE IN ITALY

NUOVI CARRELLI BI COLOR
Perché accontentarsi di un solo colore?!

L'ICONICO CARRELLO FG 100 FASANO TOOLS DIVENTA ANCHE BI COLOR!

Scegli tra le
14 VARIANTI
disponibili,
il match che
ti rappresenta
di più!

4 RUOTE IN GOMMA VULCANIZZATA
CON DIAMETRO 125 MM
(2 FISSE, 2 GIREVOLI)

VERSATILITA'

7 CASSETTI CAPIENTI,
TOTALMENTE APRIBILI E CORREDATI
DI TAPPETINO INTERNO ANTIGRAFFIO

CAPIENZA

CHIUSURA LATERALE
CENTRALIZZATA

SICUREZZA

PANNELLI LATERALI
CON FORI PER GANCI PORTA UTENSILI
E PORTA FLACONI DI SERIE

COMODITA'

TOP IN ABS
CON MANIGLIONE INTEGRATO

PRATICITA'

**L'ENERGIA
DEI NOSTRI
NUOVI
FG 100
BI COLOR**



**IL MEGLIO DEL
MADE IN ITALY**



I nostri carrelli sono
frutto di un intenso
lavoro di ricerca,
sviluppo,
progettazione
e produzione
interna.



RESTYLING

FURGONI ATTREZZATI FASANO TOOLS

I NOSTRI NUOVI FURGONI DIMOSTRATIVI SONO PIÙ CONTEMPORANEI CHE MAI!

Forniti degli utensili più rappresentativi e delle ultime novità prodotte, i furgoni Fasano Tools sono di supporto ai nostri rivenditori nel rapporto con i propri clienti finali.



Oggi, in questa nuova veste, sfoggia non solo un restyling grafico della carrozzeria, ma anche una nuova organizzazione interna che modula arredo tecnico per furgoni e utensili, al fine di rappresentare una soluzione efficiente di autofficina on the road.

INSIEME CORRIAMO PIU' VELOCI!



ED
MOTORSPORT

Durante le stagioni sportive 2022 e 2023, Fasano Tools ha affidato il ruolo di Brand Ambassador al giovane Sport Driver Eliseo Donno. L'elegantissima Ferrari 488 Evo ha portato, con onore, sui circuiti Internazionali più prestigiosi, il marchio Fasano Tools, Main Sponsor, simbolo di una partnership basata sulla reciproca fiducia e stima.

Nel 2023 Eliseo Donno è diventato Campione Europeo nel Campionato "Ferrari Challenge - Trofeo Pirelli" e ha conquistato il secondo posto sia nella competizione mondiale del medesimo campionato, che sul podio del Campionato Cult GT3.



SLP
CORSE

Il nostro partner a due ruote per il 2023 è stato il team sportivo SLP Corse.

Impegnata da decenni nelle competizioni motociclistiche, in questa stagione sportiva SLP Corse ha svolto il ruolo di Brand Ambassador Fasano Tools nel Campionato Italiano Velocità, CIV National Trophy e le emozioni che ci ha regalato Alessandro Arcangeli, "il pilota matto della 1000", già Campione 2021 del Trofeo Aprilia RS660, sono state davvero tante. Competiamo per vincere, ma anche per crescere.

DINAMIC GT

Fasano Tools sceglie la squadra sportiva Dinamic GT, attiva dal 2019 in campionati monomarca, e ne diventa Sponsor nella stagione sportiva 2023.

Nel GT World Challenge Europe, il team ha festeggiato quattro vittorie assolute con la 911 GT3 R. Inoltre è stata attiva anche sulla Nordschleife e ha partecipato come ospite all' ADAC GT Masters nel 2022.

La Porsche Verde del team, ha "indossato" il logo Fasano e, con orgoglio, lo ha sfoggiato sui circuiti Internazionali Cult delle competizioni automobilistiche per accendere, a suon di rombo di motori, la fiamma verde della vittoria.



BEFUEL

D'ispirazione per tutti i professionisti del settore della meccanica, della carrozzeria e del mondo automotive, i nostri Partner di Be Fuel Performance lavorano ormai da anni utilizzando i carrelli Made in Italy customizzati e gli utensili Fasano Tools.

Non esiste sul web un progetto che sia uguale a loro. Ai ragazzi di Be Fuel modificare e personalizzare non basta quasi più. Le auto "bacciate" dal loro tocco diventano dei veri e propri prototipi da sfoggiare in piste e competizioni prestigiose, per superare ogni volta il limite imposto.

Nel 2023 ci hanno stupiti con incredibili makeover di vetture, contest e sfide creative, esplorando nuovi orizzonti del settore Automotive.

L'azienda

Identity

Realizziamo strumenti professionali dal 1976

Nata nel 1976, l'azienda lancia nel 2002 il marchio **FASANO TOOLS** che, sin da subito, si pone sul mercato come un brand innovativo ed alternativo nel mondo dell'utensileria professionale. Oltre 40 anni di esperienza e l'ascolto continuo di fruitori e partner commerciali, hanno consentito all'impresa di crescere e diventare una realtà di riferimento nel settore, consolidare la sua presenza a livello Nazionale e rafforzare quella a livello Internazionale.

NUOVA

SEDE PRODUTTIVA

L'ampliamento della gamma di prodotti degli ultimi anni, corrisponde ad un ampliamento strutturale della sede operativa Fasano Tools.

PIÙ SPAZIO PER NUOVI PROGETTI

Con una superficie di oltre 1000 mq, il nuovo stabilimento Fasano Tools, realizzato nel 2023, oggi ospita diverse attività a pieno regime quali il taglio e la punzonatura, la piegatura automatica, la saldatura e l'assemblaggio di tutti i prodotti lamierati presenti a catalogo.



I nostri tecnici specializzati, al suo interno, lavorano, grazie all'ausilio di macchinari innovativi ad alta vocazione tecnologica, alla produzione di lamierati per la messa in opera di carrelli porta utensili, armadi, cassettiere ed ogni altro modulo e struttura di arredo tecnico industriale.

Il nuovo stabilimento, per ora a pieno regime su queste attività specifiche, nel corso del 2024 sarà destinato anche allo studio ed alla realizzazione di nuovi progetti, già in cantiere.





Fasano Tools si differenzia sul mercato per l'ampia gamma di attrezzi da lavoro che copre tutti i settori di riferimento e per la vasta e costante disponibilità dei ricambi. Punti di forza della nostra realtà sono, infatti, l'assistenza e l'attenzione alle certificazioni, volontarie e obbligatorie, alle quali sono sottoposti puntualmente i prodotti, per rispettare, come da norme vigenti, gli standard internazionali.

Supporto fondamentale per l'attività di Fasano Tools è il sito web, straordinariamente ricco di informazioni sui prodotti, schede tecniche dettagliate, manuali, elenco ricambi e strumenti innovativi per trovare l'attrezzo o il kit necessario al proprio lavoro. Come il Tool Finder, rivoluzionario motore di ricerca interno, dedicato alla gamma dei prodotti per fasatura motore.

La comunicazione di Fasano Tools si estende, inoltre, dal web al mondo dei Social media, dove si caratterizza per un'attività mirata e differente per ogni Canale.



Con oltre 40 anni di esperienza, l'azienda ha una **VISION** ben chiara.

Si propone di non perdere mai quello spirito critico verso il mondo e il mercato e, attraverso l'impegno costante e la ricerca di innovazioni a supporto del lavoro, di affrontare con flessibilità le sfide del settore e di anticiparne le evoluzioni. **Oggi come ieri.**

Il Team

Un mosaico di collaboratori professionali è la nostra ricchezza

La varietà è la nostra vera forza. Differenti professionalità e competenze specifiche, compongono la nostra squadra.

La nostra famiglia.

L'organigramma di Fasano Tools si compone di reparti costantemente in comunicazione fra loro: Direzione, Amministrazione, Contabilità, Reparto Commerciale, Reparto produzione, Reparto progettazione, Area Ricerca e Sviluppo, Area Marketing Creativo.

Ci piace lavorare in team con ruoli ben definiti, abbracciando, in ogni più piccola attività, la nostra vision, ma anche tenendo ben presenti gli obiettivi da raggiungere. Offrire utensili da lavoro sempre più performanti e in grado di adattarsi ad ogni situazione.

La **MISSION** di Fasano Tools si attua offrendo costante supporto al cliente e risposte concrete per risolvere ogni criticità con tempestività ed efficienza.

La nostra Rete

Il network Fasano nel mondo!

Fondamentale per lo sviluppo del business è stata la creazione di un network solido che, negli anni, si è composto di collaborazioni e partnership di qualità.

Fasano Tools vanta, infatti, una fitta rete di distributori a livello nazionale ed una consolidata presenza presso tanti importatori, **in oltre 30 Paesi in tutto il mondo.**

La nostra Rete si compone anche di Agenzie commerciali la cui presenza costante e capillare sul territorio, assicura la promozione, dimostrazione e relativa applicazione dei prodotti, in ambito lavorativo. Inoltre grazie al lavoro dei nostri Promotori Tecnici specializzati, si realizza un' importante attività di ascolto e feedback da parte dei clienti, nonché di assistenza mirata.

40 anni di esperienza

30 paesi in cui esportiamo

6000 prodotti in catalogo

3000mq sede logistica

1000mq sede produttiva

La Rete virtuale

Comunichiamo online la nostra passione

Abitiamo la Rete del worldwide web con creatività, comunicando tutta la passione che mettiamo nel nostro lavoro, ma anche i progetti futuri, le novità e le collaborazioni.

fasanotools.com

Il nostro sito web è costantemente aggiornato ed è un importante punto di riferimento per clienti e rivenditori che, personalizzano la propria esperienza virtuale, accedendovi tramite area riservata. Il portale propone l'intero catalogo delle nostre referenze, i promozionali, i servizi nel dettaglio, i nuovi prodotti ed i contatti.

Ogni utensile è corredato da informazioni precise, schede tecniche ed elenco dei relativi ricambi disponibili.

Inoltre grazie all'innovativo strumento **TOOL FINDER**, gli utenti del settore Automotive hanno la possibilità di cercare, in maniera semplice e veloce, il kit di Fasatura Motore necessario, in base al veicolo.



La nostra presenza sui **Social Media** si propone di instaurare un rapporto di fiducia con il nostro pubblico, basato sulla trasparenza e la sua stessa partecipazione alle nostre attività. In particolare, su **Facebook** coinvolgiamo i nostri utenti, clienti e appassionati di settore, con informazioni, video, immagini e contest dedicati.

Il nostro canale **Youtube** si popola di giorno in giorno con video dimostrativi, di approfondimento o relativi alle nostre partecipazioni ad eventi. Utilizziamo il nostro canale **Linkedin** per comunicare contenuti specifici ad esperti e professionisti del settore. Su **Instagram**, infine, comunichiamo la nostra realtà giornalmente, mostrando i retroscena della progettazione, dei processi creativi, come i nuovi prodotti ubicati nel contesto di riferimento.

Su questo canale mondiale, l'**hashtag #fasanotools** dá voce anche ai nostri clienti e partner, mostrando tutte le sfumature di una grande realtà quale è Fasano Tools.



TOOL FINDER
SCEGLI IL TUO KIT FASATURA MOTORE

Compatti

Durevoli

Potenti

I Prodotti

Ad ogni utensile un destinatario

Fasano Tools produce attrezzi ed utensili per professionisti, specialisti di settore e hobbisti innamorati della propria passione. Ogni prodotto è pensato per lo specifico ambito di riferimento, al fine di rendere lo strumento ancora più performante. Grazie all'ascolto del mercato, nel corso dei decenni l'azienda è stata capace di rinnovare costantemente l'offerta a catalogo, ed **oggi vanta più di 6.000 referenze suddivise in 17 famiglie di prodotto.**



INDUSTRIA

Tools resistenti e garantiti, per raggiungere alti standard qualitativi.



ARTIGIANATO

I nostri utensili e attrezzi utili per i diversi settori dell'artigianato.



AUTOMOTIVE

Utensili unici e dedicati, studiati per risolvere qualsiasi sfida quotidiana.

Qualità e Assistenza

Gli utensili e gli attrezzi Fasano Tools soddisfano alti **standard qualitativi e garantiscono elevate prestazioni in termini di rendimento, durevolezza e relativa reiterazione delle azioni nel tempo.**

Fieri dei nostri prodotti, garantiamo la continua disponibilità di ricambi nel tempo, nonché un' **assistenza costante e puntuale.**

DISPONIBILITÀ PRODOTTI

Il nostro magazzino vanta una vasta gamma di prodotti in pronta consegna. Il 98% delle consegne viene evaso in modo completo.

SERVIZIO SPEDIZIONE RAPIDA

Grazie all'ampia disponibilità dei prodotti, il 90% degli ordini viene evaso entro e non oltre le 24/48 ore.



24/48h





Il meglio del made in Italy

Personalizza i tuoi spazi di lavoro!

I prodotti **Fasano Tools** sono frutto di un intenso lavoro di ricerca, sviluppo e progettazione interna. La vasta gamma di prodotti che proponiamo è caratterizzata da attenzione e cura per i dettagli, ma anche da stile e design.

I banchi da lavoro, le griglie, gli armadietti e tutti gli elementi di arredamento tecnico Fasano Tools, consentono la personalizzazione degli spazi di lavoro in base alle differenti necessità professionali.

I nostri carrelli porta utensili 100% Made in Italy sono infatti realizzati in diverse varianti modello e colore. E con i set di utensili presenti negli assortimento all'interno delle cassettiere, non c'è limite alla funzionalità.

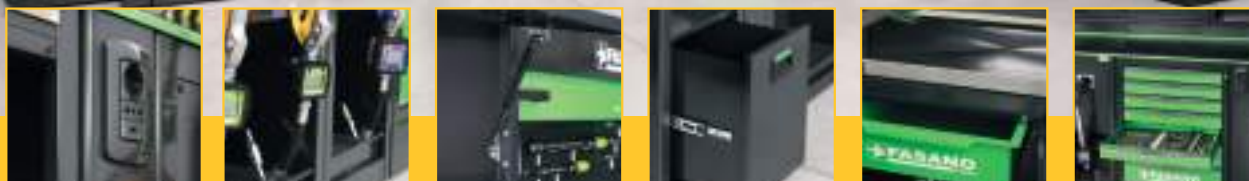

Ricerca e Sviluppo

Nuove tecnologie a servizio del lavoro

Da sempre **Fasano Tools** è attenta alle nuove esigenze del mercato e si propone di offrire novità prodotta che siano peculiari per funzione, ma anche per design e tecnologia impiegata. Per farlo, il reparto Ricerca e sviluppo è costantemente impegnato nello studio di **soluzioni innovative** che possano rendere il lavoro sempre più semplice ed i risultati ancora più efficienti.

INNOVAZIONE TECNOLOGICA

LO SMONTA AMMORTIZZATORI

Fasano Tools ha superato i controlli di sicurezza previsti dalle **Direttive Europee** in materia di certificazione CE, affidandosi al prestigioso ente Internazionale TUV Sud.





01

CHIAVI DI MANOVRA



CHIAVE COMBINATA POLIGONALE

Conforme agli standard DIN 3113
Finitura satinata lucida



CODICE	mm	L/mm	€/PZ
FG 600/B5.5	5.5	105	6,70
FG 600/B6	6	105	6,70
FG 600/B7	7	115	6,90
FG 600/B8	8	125	7,20
FG 600/B9	9	135	7,30
FG 600/B10	10	145	7,50
FG 600/B11	11	155	8,30
FG 600/B12	12	165	8,90
FG 600/B13	13	175	8,90
FG 600/B14	14	185	10,50
FG 600/B15	15	195	11,90
FG 600/B16	16	205	12,50
FG 600/B17	17	215	13,20
FG 600/B18	18	225	13,90
FG 600/B19	19	235	14,50
FG 600/B20	20	245	15,80
FG 600/B21	21	255	17,00
FG 600/B22	22	265	17,70
FG 600/B23	23	275	19,00
FG 600/B24	24	285	20,00
FG 600/B25	25	295	21,00
FG 600/B26	26	305	22,70
FG 600/B27	27	315	24,20
FG 600/B28	28	325	25,20
FG 600/B29	29	335	26,80
FG 600/B30	30	345	29,40
FG 600/B32	32	365	32,50
FG 600/B34	34	380	51,00
FG 600/B36	36	410	62,00
FG 600/B38	38	430	72,00
FG 600/B41	41	460	85,00
FG 600/B46	46	500	115,00
FG 600/B50	50	540	170,00
FG 600/B55	55	560	268,00
FG 600/B60	60	600	352,00
FG 600/B65	65	680	455,00
FG 600/B70	70	680	505,00
FG 600/B75	75	730	590,00
FG 600/B80	80	730	680,00

FASANO[®]
TOOLS



SET



SET CHIAVI COMBINATE POLIGONALI

Con supporto in ABS

CODICE	Pz	Contenuto	€/PZ
FG 600/ST7	7	8, 10, 11, 13, 14, 17, 19mm	78,00
FG 600/ST9	9	8, 10, 11, 12, 13, 14, 15, 17, 19mm	98,00
FG 600/ST11	11	8, 9, 10, 11, 12, 13, 14, 15, 16, 17, 19mm	120,00



SET CHIAVI COMBINATE POLIGONALI

In rotolo di nylon

CODICE	Pz	Contenuto	€/PZ
FG 600/SP6	6	8, 10, 13, 14, 17, 19mm	72,00
FG 600/SP9	9	8, 10, 11, 12, 13, 14, 15, 17, 19mm	102,00
FG 600/SP11	11	8, 9, 10, 11, 12, 13, 14, 15, 16, 17, 19mm	125,00



SET CHIAVI COMBINATE POLIGONALI

In box di cartone

CODICE	Pz	Contenuto	€/PZ
FG 600/SC17	17	6, 7, 8, 9, 10, 11, 12, 13, 14, 15, 16, 17, 18, 19, 20, 21, 22mm	182,00
FG 600/SC16	16	6, 7, 8, 9, 10, 11, 12, 13, 14, 16, 17, 19, 21, 22, 24, 27, 30, 32mm	232,00
FG 600/SC25	25	6, 7, 8, 9, 10, 11, 12, 13, 14, 15, 16, 17, 18, 19, 20, 21, 22, 23, 24, 25, 26, 27, 28, 30, 32mm	390,00

CHIAVE COMBINATA POLIGONALE EXTRA LUNGA

Conforme agli standard DIN 3113
Finitura satinata lucida
Acciaio al cromo vanadio



CODICE	mm	L/mm	€/PZ
FG 600/L10	10	207	11,10
FG 600/L11	11	225	11,60
FG 600/L12	12	243	12,50
FG 600/L13	13	260	12,90
FG 600/L14	14	280	13,90
FG 600/L15	15	297	15,00
FG 600/L16	16	315	16,00
FG 600/L17	17	333	17,10
FG 600/L18	18	340	18,30
FG 600/L19	19	350	20,00

SET



SET CHIAVI COMBINATE POLIGONALI EXTRA LUNGHE

In box di cartone

CODICE	Pz	Contenuto	€/PZ
FG 600L/SC10	10	10, 11, 12, 13, 14, 15, 16, 17, 18, 19mm	155,00



CHIAVE COMBINATA POLIGONALE IN POLLICI

Conforme agli standard DIN 3113
Finitura satinata lucida
Acciaio al cromo vanadio



CODICE	Pollici	L/mm	€/PZ
FG 600/IN1	1/4"	105	7,50
FG 600/IN2	5/16"	125	8,00
FG 600/IN3	3/8"	145	9,50
FG 600/IN4	7/16"	155	9,30
FG 600/IN5	1/2"	175	10,70
FG 600/IN6	9/16"	185	11,50
FG 600/IN7	5/8"	205	13,50
FG 600/IN8	11/16"	215	13,70
FG 600/IN9	3/4"	235	14,80
FG 600/IN10	13/16"	255	17,00
FG 600/IN11	7/8"	265	18,50
FG 600/IN12	15/16"	285	20,80
FG 600/IN13	1"	295	22,00
FG 600/IN14	1.1/16"	315	25,50
FG 600/IN15	1.1/8"	335	29,00
FG 600/IN16	1.1/4"	365	33,00
FG 600/IN17	1.5/16"	380	41,00
FG 600/IN18	1.3/8"	410	52,00
FG 600/IN19	1.7/16"	410	53,00
FG 600/IN20	1.1/2"	430	64,00

SET



SET CHIAVI COMBINATE POLIGONALI IN POLLICI

In box di cartone

CODICE	Pz	Contenuto	€/PZ
FG 600IN/SC13	13	1/4", 5/16", 3/8", 7/16", 1/2", 9/16", 5/8", 11/16", 3/4", 13/16", 7/8", 15/16", 1"	182,00



SET CHIAVI COMBINATE POLIGONALI IN POLLICI

In rotolo di nylon

CODICE	Pz	Contenuto	€/PZ
FG 600IN/SP6	6	1/4", 5/16", 3/8", 7/16", 1/2", 9/16", 11/16"	62,00
FG 600IN/SP9	9	1/4", 5/16", 3/8", 7/16", 1/2", 9/16", 5/8", 11/16", 3/4"	110,00
FG 600IN/SP11	11	1/4", 5/16", 3/8", 7/16", 1/2", 9/16", 5/8", 11/16", 3/4", 13/16", 1"	150,00





CHIAVE A FORCHETTA SEMPLICE

Conforme agli standard DIN 894

Finitura brunita

Acciaio al cromo molibdeno



CODICE	mm	L/mm	€/PZ
FG 601/B10	10	120	7,00
FG 601/B11	11	120	7,00
FG 601/B12	12	120	7,00
FG 601/B13	13	145	7,50
FG 601/B14	14	145	8,10
FG 601/B15	15	145	9,20
FG 601/B16	16	160	9,20
FG 601/B17	17	160	9,20
FG 601/B18	18	160	9,20
FG 601/B19	19	175	10,80
FG 601/B20	20	175	10,80
FG 601/B21	21	175	10,80
FG 601/B22	22	195	14,00
FG 601/B23	23	195	14,00
FG 601/B24	24	195	14,00
FG 601/B25	25	215	17,80
FG 601/B27	27	215	17,80
FG 601/B28	28	240	20,00
FG 601/B30	30	240	20,00
FG 601/B32	32	270	26,00
FG 601/B34	34	270	26,00
FG 601/B35	35	296	29,00
FG 601/B36	36	296	30,00
FG 601/B38	38	296	32,00
FG 601/B41	41	335	38,00
FG 601/B46	46	370	46,00
FG 601/B50	50	410	68,00
FG 601/B55	55	488	88,00
FG 601/B60	60	488	90,00
FG 601/B65	65	488	102,00
FG 601/B70	70	595	135,00
FG 601/B75	75	595	150,00
FG 601/B80	80	595	190,00

CHIAVE A DOPPIA FORCHETTA

Conforme agli standard DIN 3110

Finitura satinata lucida

Acciaio al cromo vanadio



CODICE	mm	L/mm	€/PZ
FG 602/B6x7	6x7	123	4,50
FG 602/B8x9	8x9	140	4,70
FG 602/B8X10	8x10	140	5,50
FG 602/B10X11	10x11	156	5,50
FG 602/B12X13	12x13	172	5,80
FG 602/B14X15	14x15	190	7,20
FG 602/B16X17	16x17	204	8,20
FG 602/B18X19	18x19	221	9,50
FG 602/B20X22	20x22	237	11,90
FG 602/B21X23	21x23	247	13,50
FG 602/B22X24	22x24	247	13,50
FG 602/B24X26	24x26	255	15,20
FG 602/B25X28	25x28	279	18,00
FG 602/B27X29	27x29	279	19,00
FG 602/B30X32	30x32	298	20,00
FG 602/B34X36	34x36	350	45,00
FG 602/B35X38	35x38	350	58,00
FG 602/B36X41	36x41	380	59,00
FG 602/B41X46	41x46	415	75,00
FG 602/B46X50	46x50	465	90,00

SET



SET CHIAVI A DOPPIA FORCHETTA

Con supporto in ABS

CODICE	Pz	Contenuto	€/PZ
FG 602/ST7	7	6x7, 8x9, 10x11, 12x13, 14x15, 16x17, 18x19mm	52,00
FG 602/ST9	9	6x7, 8x9, 10x11, 12x13, 14x15, 16x17, 18x19, 20x22, 21x23mm	76,00



SET CHIAVI A DOPPIA FORCHETTA

In rotolo di nylon

CODICE	Pz	Contenuto	€/PZ
FG 602/SP6	6	6x7, 8x9, 10x11, 12x13, 14x15, 16x17mm	44,00
FG 602/SP9	9	6x7, 8x9, 10x11, 12x13, 14x15, 16x17, 18x19, 20x22, 21x23mm	80,00
FG 602/SP13	13	6x7, 8x9, 10x11, 12x13, 14x15, 16x17, 18x19, 20x22, 21x23, 24x26, 25x28, 27x29, 30x32mm	158,00



SET CHIAVI A DOPPIA FORCHETTA

In box di cartone

CODICE	Pz	Contenuto	€/PZ
FG 602/SC8	8	6x7, 8x9, 10x11, 12x13, 14x15, 16x17, 18x19, 20x22mm	58,00
FG 602/SC13	13	6x7, 8x9, 10x11, 12x13, 14x15, 16x17, 18x19, 20x22, 21x23, 24x26, 25x28, 27x29, 30x32mm	145,00

CHIAVE A DOPPIA FORCHETTA IN POLLICI

Conforme agli standard DIN 3110

Finitura satinata lucida

Acciaio al cromo vanadio



CODICE	Misura mm	L/mm	€/PZ
FG 602/IN1	5/16x3/8	140	5,50
FG 602/IN2	3/8x7/16	156	6,50
FG 602/IN3	7/16x1/2	172	7,20
FG 602/IN4	1/2x9/16	180	7,70
FG 602/IN5	9/16x5/8	190	8,30
FG 602/IN6	5/8x11/16	204	10,30
FG 602/IN7	11/16x3/4	221	11,80
FG 602/IN8	3/4x7/8	255	13,50
FG 602/IN9	15/16x1	255	18,50
FG 602/IN10	1x1.1/8	279	21,50
FG 602/IN11	1.1/8x1.1/4	298	23,50

SET



SET CHIAVI A DOPPIA FORCHETTA IN POLLICI

In rotolo di nylon

CODICE	Pz	Contenuto	€/PZ
FG 602IN/SP9	9	5/16x3/8, 3/8x7/16, 7/16x1/2, 1/2x9/16, 5/8x11/16, 3/4x7/8, 15/16x1, 1x1.1/8, 1.1/8x1.1/4 (IN1, IN2, IN3, IN4, IN6, IN8, IN9, IN10, IN11)	115,00



CHIAVE A DOPPIA FORCHETTA ULTRA PIATTA

Finitura extra lucida

Acciaio al cromo vanadio

Modello ultra piatto per consentirne l'utilizzo in spazi molto ristretti



CODICE	mm	L/mm	€/PZ
FG 602/C6x7	6x7	145	5,00
FG 602/C8x9	8x9	171	5,50
FG 602/C10x11	10x11	171	5,50
FG 602/C12x13	12x13	205	7,00
FG 602/C14x15	14x15	205	7,20
FG 602/C16x17	16x17	246	10,20
FG 602/C18x19	18x19	265	10,50
FG 602/C20x22	20x22	283	14,00
FG 602/C21x23	21x23	283	14,00

SET



SET CHIAVI A DOPPIA FORCHETTA ULTRA PIATTE

In rotolo di nylon

CODICE	Pz	Contenuto	€/PZ
FG 602C/SP6	6	6x7, 8x9, 10x11, 12x13, 14x15, 16x17mm	50,00
FG 602C/SP9	9	6x7, 8x9, 10x11, 12x13, 14x15, 16x17, 18x19, 20x22, 21x23mm	92,00

CHIAVE POLIGONALE DOPPIA

Finitura satinata lucida

Acciaio al cromo vanadio



CODICE	mm	€/PZ
FG 609/A8x10	8x10	11,90
FG 609/A10x12	10x12	12,80
FG 609/A11x13	11x13	15,40
FG 609/A14x17	14x17	19,50
FG 609/A15x17	15x17	22,00
FG 609/A16x18	16x18	23,00
FG 609/A19x22	19x22	27,00

SET



SET 5 CHIAVI POLIGONALI DOPPIE

In box di cartone

CODICE	Pz	Contenuto	€/PZ
FG 609A/S5	5	10X12, 11X13, 14X17, 16X18, 19X22	102,00

CHIAVE DOPPIA DIRITTA TORX

Finitura satinata lucida

Acciaio al cromo vanadio



CODICE	Misura mm	L/mm	€/PZ
FG 600/E6x8	E6xE8	112.4	10,50
FG 600/E10x12	E10xE12	140.7	11,00
FG 600/E14x18	E14xE18	183.0	12,00
FG 600/E20x24	E20xE24	225.0	17,00

SET



SET 4 CHIAVI DOPPIE DIRITTE TORX

In box di cartone

CODICE	Pz	Contenuto	€/PZ
FG 600E/S4	4	E6xE8, E10xE12, E14xE18, E20xE24	53,56

CHIAVE A PIPA ESAGONALE-POLIGONALE

Conforme agli standard DIN 3118

Finitura lucida

Acciaio al cromo vanadio



CODICE	mm	L/mm	€/PZ
FG 613/A6	6	113	13,70
FG 613/A7	7	122	13,70
FG 613/A8	8	126	13,70
FG 613/A9	9	131	13,70
FG 613/A10	10	140	14,70
FG 613/A11	11	150	14,70
FG 613/A12	12	155	16,60
FG 613/A13	13	165	19,90
FG 613/A14	14	180	19,90
FG 613/A15	15	193	21,50
FG 613/A16	16	204	23,00
FG 613/A17	17	209	24,00
FG 613/A18	18	225	25,00
FG 613/A19	19	230	28,00
FG 613/A20	20	235	28,30
FG 613/A21	21	249	33,60
FG 613/A22	22	266	35,70
FG 613/A23	23	268	38,90
FG 613/A24	24	288	41,90
FG 613/A25	25	297	46,20
FG 613/A26	26	311	49,40
FG 613/A27	27	315	55,10
FG 613/A30	30	362	66,00
FG 613/A32	32	385	70,00

SET



SET CHIAVI A PIPA ESAGONALI-POLIGONALI

In box di cartone

CODICE	Pz	Contenuto	€/PZ
FG 613/S9	9	8, 10, 11, 12, 13, 15, 17, 18, 19mm	185,00
FG 613/S11	11	6, 7, 8, 10, 11, 12, 13, 14, 17, 19, 22mm	215,00
FG 613/S17	17	6, 7, 8, 9, 10, 11, 12, 13, 14, 15, 16, 17, 18, 19, 20, 21, 22mm	362,00

CHIAVE A TUBO MOD. PESANTE

Finitura lucida sulle estremità e satinata sul corpo

Acciaio al cromo vanadio



CODICE	mm	L/mm	€/PZ
FG 614/A6x7	6x7	106	12,40
FG 614/A8x9	8x9	108	14,70
FG 614/A10x11	10x11	122	15,80
FG 614/A12x13	12x13	138	18,40
FG 614/A14x15	14x15	148	20,00
FG 614/A16x17	16x17	157	22,00
FG 614/A18x19	18x19	165	24,00
FG 614/A20x22	20x22	175	27,30
FG 614/A21x23	21x23	186	31,00
FG 614/A24x26	24x26	195	36,80
FG 614/A25x28	25x28	207	42,00
FG 614/A27x29	27x29	209	48,30
FG 614/A30x32	30x32	209	56,00

SET



SET CHIAVI A TUBO MOD. PESANTE

In box di cartone

CODICE	Pz	Contenuto	€/PZ
FG 614A/S8	8	6x7, 8x9, 10x11, 12x13, 14x15, 16x17, 18x19, 20x22mm	158,00
FG 614A/S13	13	6x7, 8x9, 10x11, 12x13, 14x15, 16x17, 18x19, 20x22, 21x23, 24x26, 25x28, 27x29, 30x32mm	375,00

SPINA DI MANOVRA



CODICE	mm	€/PZ
FG 614/AS1	01-06-2013 00:00:00	5,60
FG 614/AS2	14-22	7,40
FG 614/AS3	21-32	12,00

CHIAVE A TUBO MOD. LEGGERO

Finitura lucida
Acciaio al cromo vanadio



CODICE	mm	L/mm	€/PZ
FG 614/B6x7	6x7	110	5,60
FG 614/B8x9	8x9	113	5,60
FG 614/B10x11	10x11	122	6,80
FG 614/B12x13	12x13	142	8,00
FG 614/B14x15	14x15	142	8,60
FG 614/B16x17	16x17	154	9,00
FG 614/B18x19	18x19	161	12,10
FG 614/B20x22	20x22	170	15,50
FG 614/B21x23	21x23	172	16,60
FG 614/B24x26	24x26	189	18,80
FG 614/B25x28	25x28	200	21,50
FG 614/B27x29	27x29	200	24,50
FG 614/B30x32	30x32	202	27,50

SET



SET CHIAVI A TUBO MOD. LEGGERO

In box di cartone

CODICE	Pz	Contenuto	€/PZ
FG 614B/S8	8	6x7, 8x9, 10x11, 12x13, 14x15, 16x17, 18x19, 20x22mm	75,00
FG 614B/S13	13	6x7, 8x9, 10x11, 12x13, 14x15, 16x17, 18x19, 20x22, 21x23, 24x26, 25x28, 27x29, 30x32mm	185,00

CHIAVE A TUBO SNODATA DOPPIA

Finitura lucida
Acciaio al cromo vanadio

NEW



CODICE	mm	L/mm	€/PZ
FG 614/C6x7	6x7	185	24,00
FG 614/C8x9	8x9	185	24,00
FG 614/C10x11	10x11	197	24,00
FG 614/C12x13	12x13	218	28,00
FG 614/C14x15	14x15	239	32,00
FG 614/C16x17	16x17	255	38,00
FG 614/C18x19	18x19	271	45,00
FG 614/C20x22	20x22	307	45,00
FG 614/C21x23	21x23	307	45,00
FG 614/C24x27	24x27	335	85,00
FG 614/C30x32	30x32	345	92,00

SET



SET CHIAVI A TUBO SNODATE DOPPIE

In box di cartone

NEW

CODICE	Pz	Contenuto	€/PZ
FG 614C/S8	8	6x7, 8x9, 10x11, 12x13, 14x15, 16x17, 18x19, 20x22 mm	265,00
FG 614C/S11	11	6x7, 8x9, 10x11, 12x13, 14x15, 16x17, 18x19, 20x22, 21x23, 24x27, 30x32 mm	485,00

CHIAVE A T ESAGONALE SEMPLICE

Finitura lucida
Acciaio al cromo vanadio



CODICE	mm	A/mm	L1/mm	L2/mm	€/PZ
FG 616/A8	8	10.0	160.0	220.0	17,50
FG 616/A10	10	12.0	160.0	230.0	19,50
FG 616/A12	12	15.0	175.0	242.0	22,00
FG 616/A13	13	18.0	175.0	246.0	22,50
FG 616/A14	14	19.0	190.0	252.0	23,50
FG 616/A17	17	23.0	220.0	267.0	28,00

SET



SET 6 CHIAVI A T ESAGONALI SEMPLICI

CODICE	Pz	Contenuto	€/PZ
FG 616A/S6	6	8, 10, 12, 13, 14, 17mm	135,00



CHIAVE A T ESAGONALE SNODATA

Finitura satinata lucida
Acciaio al cromo vanadio



Snodo cardanico rinforzato

CODICE	mm	L2/mm	L1/mm	€/PZ
FG 618/A6	6	396	146	30,50
FG 618/A7	7	397	146	30,50
FG 618/A8	8	397	146	31,00
FG 618/A9	9	397	146	31,00
FG 618/A10	10	403	160	34,00
FG 618/A11	11	403	160	34,50
FG 618/A12	12	403	160	35,00
FG 618/A13	13	431	175	38,00
FG 618/A14	14	431	175	38,00
FG 618/A15	15	448	200	45,50
FG 618/A16	16	448	200	45,50
FG 618/A17	17	448	200	45,50
FG 618/A18	18	448	200	45,50
FG 618/A19	19	501	230	56,00
FG 618/A20	20	501	230	56,00
FG 618/A21	21	501	230	56,00
FG 618/A22	22	501	230	56,00
FG 618/A23	23	501	230	56,00
FG 618/A24	24	501	230	56,00

SET



SET CHIAVI A T SNODATE ESAGONALI

In box di cartone

CODICE	Pz	Contenuto	€/PZ
FG 618/S7B	7	7, 8, 10, 12, 13, 14, 17mm	257,50
FG 618/S7	7	8, 10, 11, 13, 14, 17, 19mm	278,50
FG 618/S10	10	8, 10, 11, 12, 13, 14, 15, 16, 17, 19mm	404,50
FG 618/S18	18	6, 7, 8, 9, 10, 11, 12, 13, 14, 15, 16, 17, 18, 19, 20, 21, 22, 24mm	762,50

CHIAVE A T MASCHIO ESAGONALE SNODATA

Finitura satinata lucida
Acciaio al cromo vanadio



Snodo cardanico rinforzato

CODICE	mm	L2/mm	L1/mm	€/PZ
FG 619/H3	3	399	146	34,50
FG 619/H4	4	399	146	34,50
FG 619/H5	5	399	146	34,50
FG 619/H6	6	430	175	42,00
FG 619/H8	8	430	175	43,50
FG 619/H10	10	430	175	48,50

SET



SET CHIAVI A T MASCHIO ESAGONALI SNODATE

In box di cartone

CODICE	Pz	Contenuto	€/PZ
FG 619H/S5	5	3, 4, 5, 6, 8mm	191,50
FG 619H/S6	6	3, 4, 5, 6, 8, 10mm	238,50

CHIAVE A T SNODATA TORX

Finitura satinata lucida
Acciaio al cromo vanadio

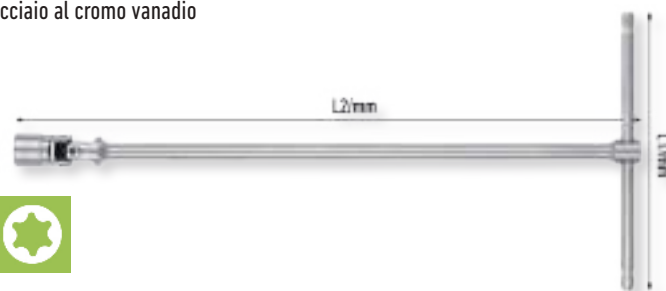

CODICE	mm	L2/mm	L1/mm	€/PZ
FG 618/E6	E6	396	146	36,00
FG 618/E7	E7	396	146	36,00
FG 618/E8	E8	396	146	40,00
FG 618/E10	E10	396	146	40,00
FG 618/E12	E12	405	160	47,50
FG 618/E14	E14	405	160	59,00
FG 618/E16	E16	433	175	59,00
FG 618/E18	E18	449	200	60,00
FG 618/E20	E20	449	200	60,00

SET



SET CHIAVI A T SNODATE TORX

In box di cartone

CODICE	Pz	Contenuto	€/PZ
FG 618E/S9	9	E6, E7, E8, E9, E10, E12, E14, E16, E18, E20	439,00

CHIAVE A T MASCHIO TORX SNODATA

Finitura satinata lucida
Acciaio al cromo vanadio



CODICE	mm	L2/mm	L1/mm	€/PZ
FG 619/TX20	TX20	399	146	39,50
FG 619/TX25	TX25	399	146	39,50
FG 619/TX27	TX27	399	146	39,50
FG 619/TX30	TX30	399	146	39,50
FG 619/TX40	TX40	412	160	43,50
FG 619/TX45	TX45	412	160	45,50
FG 619/TX50	TX50	437	175	48,50
FG 619/TX55	TX55	437	175	53,00

SET



SET CHIAVI A T SNODATE TORX

In box di cartone

CODICE	Pz	Contenuto	€/PZ
FG 619TX/S8	8	TX20, 25, 27, 30, 40, 45, 50, 55	350,50

CHIAVE A T MASCHIO ESAGONALE CON ASTA SCORREVOLE

Conforme agli standard DIN 65253/65254
Finitura lucida
Acciaio al cromo vanadio
Teste brunite



CODICE	mm	L2/mm	L1/mm	€/PZ
FG 621/H2	2	125	62	14,30
FG 621/H2,5	2,5	125	62	14,30
FG 621/H3	3	126	62	14,30
FG 621/H3,5	3,5	127	64	14,30
FG 621/H4	3,5	185	90	15,60
FG 621/H4,5	4	181	85	16,80
FG 621/H5	5	185	90	18,50
FG 621/H6	6	210	100	21,50
FG 621/H7	7	212	105	21,50
FG 621/H8	8	252	121	22,00
FG 621/H9	9	300	145	25,00
FG 621/H10	10	302	150	27,80
FG 621/H12	12	322	166	29,50
FG 621/H14	14	344	172	38,00

SET



SET CHIAVI A T MASCHIO ESAGONALI

In box di cartone

CODICE	Pz	Contenuto	€/PZ
FG 621H/S8	8	2, 2.5, 3, 3.5, 4, 5, 6, 8mm	139,00
FG 621H/S8B	8	2, 2.5, 3, 3.5, 4, 4.5, 5, 6mm	132,00
FG 621H/S8C	8	2, 2.5, 3, 4, 5, 6, 8, 10mm	152,00
FG 621H/S14	14	2, 2.5, 3, 3.5, 4, 4.5, 5, 6, 7, 8, 9, 10, 12, 14mm	298,00



CHIAVE A T MASCHIO TORX CON ASTA SCORREVOLE

Conforme agli standard DIN 65253/65254

Finitura lucida

Acciaio al cromo vanadio

Teste brunite



CODICE	mm	L2/mm	L1/mm	€/PZ
FG 621/TX6	6	127	65	15,80
FG 621/TX7	7	127	65	15,80
FG 621/TX8	8	127	65	15,80
FG 621/TX9	9	125	65	15,80
FG 621/TX10	10	127	65	15,80
FG 621/TX15	15	127	65	15,80
FG 621/TX20	20	127	65	15,80
FG 621/TX25	25	185	90	16,80
FG 621/TX27	27	185	90	16,80
FG 621/TX30	30	185	90	16,80
FG 621/TX40	40	213	105	20,00
FG 621/TX45	45	212	107	23,00
FG 621/TX50	50	215	107	25,00

SET



SET CHIAVI A T MASCHIO TORX CON ASTA SCORREVOLE

In box di cartone

CODICE	Pz	Contenuto	€/PZ
FG 621TX/S8B	8	10, 15, 20, 25, 27, 30, 40, 45 TX	145,00
FG 621TX/S13	13	6, 7, 8, 9, 10, 15, 20, 25, 27, 30, 40, 45, 50 TX	235,00

CHIAVE A T MASCHIO ESAGONALE AD ASTA FISSA

Finitura lucida

Acciaio al cromo vanadio



CODICE	mm	L2/mm	L1/mm	€/PZ
FG 622/H2	2	62	125	20,00
FG 622/H2.5	2,5	62	125	20,00
FG 622/H3	3	75	150	20,50
FG 622/H3.5	3,5	75	150	20,50

CODICE	mm	L2/mm	L1/mm	€/PZ
FG 622/H4	4	90	180	22,50
FG 622/H4.5	4,5	90	180	22,50
FG 622/H5	5	105	210	24,00
FG 622/H6	6	105	210	26,00
FG 622/H7	7	105	210	26,00
FG 622/H8	8	125	250	32,00
FG 622/H9	9	140	280	32,00
FG 622/H10	10	150	300	42,00
FG 622/H12	12	160	320	52,00
FG 622/H14	14	170	340	60,00

SET



SET CHIAVI A T MASCHIO ESAGONALE CON ASTA FISSA

CODICE	Pz	Contenuto	€/PZ
FG 622H/S6	6	2,5, 3, 4, 5, 6, 8mm	155,00
FG 622H/S7	7	2,5, 3, 4, 5, 6, 8, 10mm	195,00

CHIAVE A SETTORE ARTICOLATA CON NASELLO QUADRO

Conforme agli standard DIN 1804

Finitura satinata lucida

Acciaio al cromo vanadio



CODICE	Capacità	A/mm	L/mm	€/PZ
FG 36/1	13-35	4.96	168.0	28,00
FG 36/2	35-50	5.94	214.0	31,50
FG 36/3	50-80	7.65	280.0	42,50
FG 36/4	80-120	8.60	342.0	57,00
FG 36/5	120-180	10.75	480.0	76,00

CHIAVE A SETTORE CON NASELLO QUADRO

Finitura satinata lucida
Acciaio al cromo vanadio



CODICE	Capacità	A/mm	L/mm	€/PZ
FG 38/1	16-18-20	2.0	108.0	9,00
FG 38/2	22-25-28	2.5	135.0	11,00
FG 38/3	30-32	2.5	135.0	11,00
FG 38/4	34-36-38	3.0	170.0	13,00
FG 38/5	40-42	3.0	170.0	13,00
FG 38/6	45-50	3.5	206.0	16,50
FG 38/7	52-55	3.5	206.0	16,50
FG 38/8	58-62-65	4.0	241.0	19,50
FG 38/9	68-70-75	4.0	241.0	19,50
FG 38/10	80-85-90	5.0	280.0	26,00
FG 38/11	92-95-100	5.0	280.0	26,00
FG 38/12	110-115	5.0	334.0	38,00
FG 38/13	120-130	5.0	334.0	44,00
FG 38/14	135-145	6.0	385.0	60,00
FG 38/15	155-165	6.0	385.0	60,00
FG 38/16	180-195	6.0	466.0	78,00

CHIAVE A SETTORE ARTICOLATA CON NASELLO TONDO

Conforme agli standard DIN 1816
Finitura satinata lucida
Acciaio al cromo vanadio



CODICE	Capacità	A/mm	L/mm	€/PZ
FG 37/1	13-35	2.74	168.0	28,50
FG 37/2	35-50	3.77	210.0	34,00
FG 37/3	50-80	4.77	280.0	44,50
FG 37/4	80-120	5.74	348.0	61,00
FG 37/5	120-180	7.76	495.0	78,00

NASELLI DI RICAMBIO PER FG 37

Conforme agli standard DIN 1816



CODICE	€/PZ
FG 37/1R	6,00
FG 37/2R	7,00
FG 37/3R	9,50
FG 37/4R	12,50
FG 37/5R	15,00

CHIAVE POLIGONALE A PERCUSSIONE

Conforme agli standard DIN 7444
Acciaio al cromo molibdeno
Finitura brunita



CODICE	mm	A/mm	L/mm	€/PZ
FG 604/A24	24	43.4	168	24,20
FG 604/A27	27	46.0	180	27,80
FG 604/A30	30	51.5	190	34,50
FG 604/A32	32	54.0	190	35,50
FG 604/A36	36	58.5	205	51,50
FG 604/A41	41	65.0	230	58,70
FG 604/A46	46	73.5	240	71,00
FG 604/A50	50	78.5	253	84,50
FG 604/A55	55	85.0	266	96,00
FG 604/A60	60	92.0	280	115,00
FG 604/A65	65	102.0	300	142,00
FG 604/A70	70	110.0	330	170,00
FG 604/A75	75	110.0	330	185,00
FG 604/A80	80	118.0	340	298,00
FG 604/A85	85	130.0	355	338,00
FG 604/A90	90	142.0	390	380,00
FG 604/A95	95	142.0	390	443,00
FG 604/A100	100	155.0	420	546,00
FG 604/A105	105	155.0	420	616,00
FG 604/A110	110	168.0	450	638,00
FG 604/A115	115	168.0	450	716,00
FG 604/A120	120	182.0	480	1.020,00
FG 604/A125	125	182.0	480	1.298,00
FG 604/A130	130	194.0	510	1.535,00
FG 604/A135	135	194.0	510	1.680,00

CHIAVE A FORCHETTA A PERCUSSIONE

Conforme agli standard DIN 3113
Acciaio al cromo molibdeno
Finitura brunita



CODICE	mm	A/mm	L/mm	€/PZ
FG 604/B24	24	56.0	180	26,00
FG 604/B27	27	56.0	180	27,00
FG 604/B30	30	62.0	190	33,00
FG 604/B32	32	62.0	190	35,00
FG 604/B36	36	76.0	215	50,00
FG 604/B41	41	86.0	235	60,00
FG 604/B46	46	98.0	255	76,00
FG 604/B50	50	105.0	275	88,00
FG 604/B55	55	116.0	300	102,00
FG 604/B60	60	128.0	320	120,00
FG 604/B65	65	138.0	342	148,00
FG 604/B70	70	154.0	375	190,00
FG 604/B75	75	154.0	375	202,00
FG 604/B80	80	161.0	360	305,00
FG 604/B85	85	168.0	380	335,00
FG 604/B90	90	184.0	400	375,00
FG 604/B95	95	184.0	400	385,00
FG 604/B100	100	200.0	430	530,00
FG 604/B105	105	200.0	430	598,00
FG 604/B110	110	215.0	465	660,00
FG 604/B115	115	215.0	465	750,00
FG 604/B120	120	238.0	500	780,00
FG 604/B125	125	238.0	500	885,00



CHIAVE POLIGONALE CURVA MOD. PESANTE

Finitura satinata lucida

Acciaio al cromo vanadio

Da utilizzare con aste di manovra FG 624D/PR



CODICE	mm	A/mm	€/PZ
FG 604/D24	38	100	46,00
FG 604/D27	41	190	48,00
FG 604/D30	48	200	52,00
FG 604/D32	49	235	59,00
FG 604/D36	55	245	65,00
FG 604/D41	62	265	82,00
FG 604/D46	69	280	90,00
FG 604/D50	76	290	107,00
FG 604/D55	81	300	118,00
FG 604/D60	90	345	152,00
FG 604/D65	95	355	180,00
FG 604/D70	105	365	200,00
FG 604/D75	110	375	222,00
FG 604/D80	125	385	252,00
FG 604/D85	125	385	265,00
FG 604/D90	140	410	462,00
FG 604/D95	140	410	494,00
FG 604/D100	143	412	525,00

ASTA DI MANOVRA PER FG 604/D



CODICE	L/mm	mm	€/PZ
FG 604D/PR1	460	24-30	34,00
FG 604D/PR2	580	32-41	52,00
FG 604D/PR3	760	46-55	73,00
FG 604D/PR4	860	60-100	97,00

CHIAVE COMBINATA A CRICCO REVERSIBILE CON ANELLO DI TENUTA

Conforme agli standard ISO 1711-1

Finitura satinata lucida

Acciaio al cromo vanadio



Anello in acciaio integrato che consente la tenuta del bullone



Leva di inversione a filo testa e con linguetta inclinata verso il basso per consentire un maggior spazio di manovra

CODICE	mm	L/mm	€/PZ
FG 605/A6	6	128.0	16,00
FG 605/A7	7	140.0	16,00
FG 605/A8	8	140.0	16,00
FG 605/A9	9	149.0	17,00
FG 605/A10	10	158.0	17,50
FG 605/A11	11	165.0	18,00

CODICE	mm	L/mm	€/PZ
FG 605/A12	12	171.0	18,80
FG 605/A13	13	178.0	19,30
FG 605/A14	14	190.0	20,50
FG 605/A15	15	199.0	21,50
FG 605/A16	16	208.0	23,70
FG 605/A17	17	225.0	23,70
FG 605/A18	18	236.0	25,90
FG 605/A19	19	247.0	25,90

SET



SET CHIAVI A CRICCO REVERSIBILI

Con supporto in ABS

CODICE	Pz	Contenuto	€/PZ
FG 605/ST9-B	9	8, 10, 11, 12, 14, 15, 17, 19mm	190,00
FG 605/ST11-B	10	8, 9, 10, 11, 12, 13, 14, 15, 16, 17, 19mm	232,00

CHIAVE COMBINATA A CRICCO REVERSIBILE

Conforme agli standard DIN 3113

Finitura satinata lucida

Acciaio al cromo vanadio



CODICE	mm	L/mm	€/PZ
FG 605/B6	6	134.0	12,80
FG 605/B7	7	158.0	12,80
FG 605/B8	8	134.0	13,20
FG 605/B9	9	158.0	13,20
FG 605/B10	10	158.0	13,20
FG 605/B11	11	164.0	13,80
FG 605/B12	12	167.0	14,60
FG 605/B13	13	177.0	15,30
FG 605/B14	14	189.8	15,90
FG 605/B15	15	198.0	17,10
FG 605/B16	16	204.0	18,20
FG 605/B17	17	224.0	20,00
FG 605/B18	18	235.4	21,00
FG 605/B19	19	246.9	22,00
FG 605/B21	21	280.0	31,50
FG 605/B22	22	280.0	31,50
FG 605/B24	24	310.0	37,80
FG 605/B27	27	330.0	50,40
FG 605/B30	30	425.0	71,40
FG 605/B32	32	425.0	73,50

SET



SET CHIAVI COMBinate REVERSIBILI

In rotolo di nylon

CODICE	Pz	Contenuto	€/PZ
FG 605/SP6	6	8, 10, 13, 14, 17, 19mm	110,00
FG 605/SP9	9	8, 10, 11, 12, 13, 14, 15, 17, 19mm	158,00
FG 605/SP11	11	8, 9, 10, 11, 12, 13, 14, 15, 16, 17, 19mm	191,00



SET CHIAVI COMBinate REVERSIBILI

In box di cartone

CODICE	Pz	Contenuto	€/PZ
FG 605/SC12	12	8, 9, 10, 11, 12, 13, 14, 15, 16, 17, 18, 19, 22mm	198,00
FG 605/SC15	15	6, 7, 8, 9, 10, 11, 12, 13, 14, 15, 16, 17, 18, 19, 22mm	258,00
FG 605/SC19	19	6, 7, 8, 9, 10, 11, 12, 13, 14, 15, 16, 17, 18, 19, 22, 24, 27, 30, 32mm	488,00

CHIAVE COMBINATA A CRICCO NON REVERSIBILE

Conforme agli standard DIN 3113

Finitura satinata lucida

Acciaio al cromo vanadio



CODICE	mm	L/mm	€/PZ
FG 606/B8	8	134.4	10,80
FG 606/B9	9	158.5	11,10
FG 606/B10	10	158.5	11,40
FG 606/B11	11	164.6	11,40
FG 606/B12	12	167.7	12,10
FG 606/B13	13	177.4	12,70
FG 606/B14	14	189.8	13,30
FG 606/B15	15	198.4	14,60
FG 606/B16	16	205.4	14,90
FG 606/B17	17	224.4	16,30
FG 606/B18	18	235.4	17,80
FG 606/B19	19	246.9	18,10

SET



SET CHIAVI COMBinate NON REVERSIBILI

In rotolo di nylon

CODICE	Pz	Contenuto	€/PZ
FG 606/SP6	6	8, 10, 13, 14, 17, 19mm	93,00
FG 606/SP9	9	8, 10, 11, 12, 13, 14, 15, 17, 19mm	132,00

CHIAVE COMBINATA A CRICCO FLESSIBILE

Conforme agli standard DIN 3113

Finitura satinata lucida

Acciaio al cromo vanadio



CODICE	mm	L/mm	€/PZ
FG 610/FL8	8	134	19,50
FG 610/FL9	9	158	19,50
FG 610/FL10	10	158	20,50
FG 610/FL11	11	164	21,00
FG 610/FL12	12	167	22,00
FG 610/FL13	13	177	22,60
FG 610/FL14	14	189	25,00
FG 610/FL15	15	198	25,20
FG 610/FL16	16	204	27,00
FG 610/FL17	17	224	29,00
FG 610/FL18	18	235	30,00
FG 610/FL19	19	245	30,00

SET



SET CHIAVI COMBinate A CRICCO FLESSIBILI

In rotolo di nylon

CODICE	Pz	Contenuto	€/PZ
FG 610FL/SP6	6	8, 10, 13, 15, 17, 19mm	155,00
FG 610FL/SP9	9	8, 10, 12, 13, 15, 16, 17, 18, 19mm	236,00
FG 610FL/SP11	11	8, 10, 11, 12, 13, 14, 15, 16, 17, 18, 19mm	285,00





02

CHIAVI A BUSSOLA



CHIAVE A BUSSOLA ESAGONALE - ATTACCO 1/4"

Acciaio al cromo vanadio
Finitura cromata lucida

NEW



CODICE	mm	A/mm	B/mm	D/mm	E/mm	€/PZ
FG 624/E4	4	6.8	11.6	25.3	8.4	3,50
FG 624/E4,5	4.5	6.9	11.6	25.3	9	3,50
FG 624/E5	5	7.9	12.0	25.4	9.0	3,50
FG 624/E5,5	5.5	8	12.0	25.4	10	3,50
FG 624/E6	6	9.5	12.0	25.4	11.6	3,50
FG 624/E7	7	10.5	12.0	25.4	11.6	3,50
FG 624/E8	8	12.0	12.0	25.5	11.0	3,50
FG 624/E9	9	12.9	12.9	25.5	10.6	3,50
FG 624/E10	10	14.4	14.4	25.5	12.0	3,50
FG 624/E11	11	15.6	15.6	25.5	11.7	3,50
FG 624/E12	12	16.7	16.7	25.3	11.6	3,50
FG 624/E13	13	17.7	17.7	25.5	11.6	3,50
FG 624/E14	14	17.7	17.7	25.5	11.6	3,70

SET



SET 11 CHIAVI A BUSSOLA ESAGONALI - ATTACCO 1/4"

Fornito su supporto in ABS appendibile con ganci a clip e meccanismo finecorsa anticaduta

CODICE	Pz	€/PZ
FG 624/S11	4, 5, 6, 7, 8, 9, 10, 11, 12, 13, 14 mm	43,50



SET 11 CHIAVI A BUSSOLA ESAGONALI CON CRICCHETTO - ATTACCO 1/4"

Fornito su supporto in ABS appendibile con ganci a clip e meccanismo finecorsa anticaduta

CODICE	Pz	€/PZ
FG 624/S12	4, 5, 6, 7, 8, 9, 10, 11, 12, 13, 14 mm	82,50
	FG 624/CR14	

SET 25 UTENSILI - ATTACCO 1/4"

Fornito in box di ABS



CODICE	Pz	€/PZ
FG 624/S25A	25	85,00

CONTENUTO

	FG 624/E	5, 6, 8, 10, 11, 13mm
	FG 624/MCH14	
	ADATTATORE	1/4"x1/4"
	FG 85/25PH	1, 2, 3
	FG 85/25PZ	1, 2, 3
	FG 85/25F	3, 5
	FG 85/25H	4, 5, 6
	FG 85/25TX	10, 15, 20, 25, 30, 40

SET 25 UTENSILI - ATTACCO 1/4"

Fornito in box di ABS



CODICE	Pz	€/PZ
FG 624/S25	25	90,00

CONTENUTO

	FG 624/E	6, 8, 10, 11, 12, 13mm
	FG 624/CR14	
	FG 89/38P11	1/4"x 1/4"
	FG 85/25PH	1, 2, 3
	FG 85/25PZ	1, 2, 3
	FG 85/25F	4, 5, 6, 7
	FG 85/25TX	10, 15, 20, 25, 30, 40

SET 18 UTENSILI - ATTACCO 1/4"

Fornito in box di ABS



CODICE	Pz	€/PZ
FG 624/S18	18	139,50

CONTENUTO

	FG 624/E	4, 5, 6, 7, 8, 9, 10, 11, 12, 13, 14mm
	FG 624/CR14	
	FG 624/ES14	
	FG 624/PA	50, 100
	FG 624/PRF150	
	FG 624/GR14C	
	FG 624/SN14	

SET 45 UTENSILI - ATTACCO 1/4"

Fornito in box di ABS



CODICE	Pz	€/PZ
FG 624/S45	45	210,00

CONTENUTO

	FG 624/E	4, 5, 6, 7, 8, 9, 10, 11, 12, 13, 14mm
	FG 624/CR14	
	FG 624/ES14	
	FG 624/PA	50, 100
	FG 624/PRF150	
	FG 624/SN14	
	FG 624/GR14C	
	FG 148/H, FG 148/TX, FG 148/PH, FG 148/F	1.5-10, 8-40, 1-4, 1-5



CHIAVE A BUSSOLA ESAGONALE LUNGA - ATTACCO 1/4"

Acciaio al cromo vanadio
Finitura cromata lucida



CODICE	mm	A/mm	B/mm	D/mm	E/mm	€/PZ
FG 624E/L4	4	7.0	12.0	4.0	51.0	7,50
FG 624E/L5	5	8.0	12.0	9.0	51.0	7,50
FG 624E/L6	6	9.0	12.0	11.0	51.0	7,50
FG 624E/L7	7	11.0	12.0	21.0	51.0	7,50
FG 624E/L8	8	11.0	12.0	21.0	51.0	8,00
FG 624E/L9	9	13.0	12.0	21.0	51.0	8,00
FG 624E/L10	10	15.0	15.0	21.0	51.0	8,00
FG 624E/L11	11	15.1	15.0	21.0	51.0	8,00
FG 624E/L12	12	16.8	15.6	21.0	51.0	8,00
FG 624E/L13	13	16.8	15.6	21.0	51.0	8,00
FG 624E/L14	14	19.8	17.7	21.0	51.0	8,00

SET



SET 11 CHIAVI A BUSSOLA ESAGONALI LUNGHE - ATTACCO 1/4"

Fornito su supporto in ABS appendibile con ganci a clip e meccanismo finecorsa anticaduta

CODICE	Pz	Contenuto	€/PZ
FG 624L/S11	11	4,5,6,7,8,9,10,11,12,13,14mm	98,00



SET 29 UTENSILI - ATTACCO 1/4"

Fornito in box di ABS



CODICE	Pz	€/PZ
FG 624/S29	29	210,00

CONTENUTO

	FG 624/E FG 624E/L	4,5,6,7,8,9,10,11,12,13,14mm
	FG 624/CR14	
	FG 624/PA	50, 100
	FG 624/PRF150	
	FG 624/ES14	
	FG 624/SN14	
	FG 624/GR14C	

CHIAVE A BUSSOLA ESAGONALE IN POLLICI - ATTACCO 1/4"

Acciaio al cromo vanadio
Finitura cromata lucida



CODICE	Pollici	A/mm	B/mm	D/mm	E/mm	€/PZ
FG 624A/IN1	5/32	6.8	11.6	25.3	8.4	3,60
FG 624A/IN2	3/16	7.7	12.0	25.4	10.7	3,60
FG 624A/IN3	7/32	8.7	12.0	25.4	10.9	3,60
FG 624A/IN4	1/4	9.5	12.0	25.4	11.6	3,60
FG 624A/IN5	9/32	10.5	12.0	25.4	11.6	3,60
FG 624A/IN6	5/16	12.0	12.0	25.5	11.0	3,60
FG 624A/IN7	11/32	12.9	12.9	25.5	10.6	3,60
FG 624A/IN8	3/8	14.4	14.4	25.5	12.0	3,60
FG 624A/IN9	7/16	15.6	15.6	25.5	11.7	3,60
FG 624A/IN10	15/32	16.7	16.7	25.3	11.6	3,60
FG 624A/IN11	1/2	17.7	17.7	25.5	11.6	3,60
FG 624A/IN12	9/16	17.7	17.7	25.5	11.6	3,60

SET



SET 12 CHIAVI A BUSSOLA ESAGONALI IN POLLICI - ATTACCO 1/4"

Fornito su supporto in ABS appendibile con ganci a clip e meccanismo finecorsa anticaduta

CODICE	Pz	Contenuto	€/PZ
FG 624A/INS12	12	5/32,3/16,7/32,1/4,9/32,5/16,11/32,3/8,7/16,15/32,1/2,9/16	55,00

CHIAVE A BUSSOLA UNIVERSALE - ATTACCO 1/4"

Utilizzabile con bulloni esagonali (sia integri che danneggiati fino al 50%), poligonali, Torx, quadrati e XZN

Acciaio al cromo vanadio
Finitura cromata lucida



CODICE	mm	E	■	B/mm	C/mm	€/PZ
FG 624/U4	4	E5	-	7.0	9.5	3,80
FG 624/U4.5	4.5	-	-	7.5	9.5	3,80
FG 624/U5	5	E6	-	8.0	9.5	3,80
FG 624/U5.5	5.5	-	-	8.8	10.0	3,80
FG 624/U6	6	E8	-	9.6	10.0	3,80
FG 624/U7	7	-	-	10.6	10.0	3,80
FG 624/U8	8	E10	-	11.6	10.0	4,20
FG 624/U9	9	-	-	13.4	11.5	4,20
FG 624/U10	10	E12	8	14.0	11.5	4,20
FG 624/U11	11	E14	-	15.8	11.5	4,20
FG 624/U12	12	E16	10	16.9	11.5	4,20
FG 624/U13	13	E18	11	18.0	11.5	4,20
FG 624/U14	14	-	12	20.0	11.5	4,20

SET



SET 13 CHIAVI A BUSSOLA UNIVERSALI - ATTACCO 1/4"

Fornito su supporto in ABS appendibile con ganci a clip e meccanismo finecorsa anticaduta

CODICE	Pz	Contenuto	€/PZ
FG 624U/S13	13	4,4.5,5,5.5,6,7,8,9,10,11,12,13,14mm	64,00

CHIAVE A BUSSOLA TORX - ATTACCO 1/4"

Acciaio al cromo vanadio
Finitura cromata lucida



CODICE	E	A/mm	B/mm	L/mm	€/PZ
FG 624/TX4	4	11.8	6.8	25.0	6,00
FG 624/TX5	5	11.8	8.0	25.0	6,00
FG 624/TX6	6	11.8	9.3	25.0	6,00
FG 624/TX7	7	11.8	10.6	25.0	6,00
FG 624/TX8	8	11.8	11.8	25.0	6,00
FG 624/TX10	10	11.8	11.8	25.0	6,00

SET



SET 6 CHIAVI A BUSSOLA TORX - ATTACCO 1/4"

Fornito su supporto in ABS appendibile con ganci a clip e meccanismo finecorsa anticaduta

CODICE	Pz	Contenuto	€/PZ
FG 624TX/S6	6	4,5,6,7,8,10E	48,00

SET 14 UTENSILI IMPRONTA TORX - ATTACCO 1/4"

Fornito in box di ABS



CODICE	Contenuto	€/PZ
FG 624TX/S17	FG 624/TX4, TX5, TX6, TX7, TX8, TX10 FG 147/TX9, TX10, TX15, TX20, TX25, TX27, TX30, TX40 FG 624/PA100 FG 624/SN14 FG 624/ES14	78,50



CHIAVE A BUSSOLA DA 1/4" CON INSERTO PER VITI AD IMPRONTA TORX

Bussola in acciaio al cromo vanadio e finitura cromata lucida
Inserto fosfatato con finitura brunita



CODICE	TX	L/mm	€/PZ
FG 147/TX9	9	36.0	8,50
FG 147/TX10	10	36.0	8,50
FG 147/TX15	15	36.0	8,50
FG 147/TX20	20	36.0	8,50
FG 147/TX25	25	36.0	8,50
FG 147/TX27	27	36.0	8,50
FG 147/TX30	30	36.0	8,50
FG 147/TX40	40	36.0	8,50

SET



SET 8 CHIAVI A BUSSOLA DA 1/4" CON INSERTI PER VITI AD IMPRONTA TORX

Fornito su supporto in ABS appendibile con ganci a clip e meccanismo finecorsa anticaduta

CODICE	Pz	Contenuto	€/PZ
FG 147TX/S8	8	TX9, 10, 15, 20, 25, 27, 30, 40	73,50

CHIAVE A BUSSOLA DA 1/4" CON INSERTO PER VITI AD IMPRONTA PENTALOBATA

Bussola in acciaio al cromo vanadio e finitura cromata lucida
Inserto fosfatato con finitura brunita



CODICE	PT	L/mm	€/PZ
FG 147/PT10	10	36.0	10,00
FG 147/PT15	15	36.0	10,00
FG 147/PT20	20	36.0	10,00
FG 147/PT25	25	36.0	10,00
FG 147/PT27	27	36.0	10,00
FG 147/PT30	30	36.0	10,00

SET



SET 6 CHIAVI A BUSSOLA DA 1/4" CON INSERTI PER VITI AD IMPRONTA PENTALOBATA

Fornito su supporto in ABS appendibile con ganci a clip e meccanismo finecorsa anticaduta

CODICE	Pz	Contenuto	€/PZ
FG 147PT/S6	6	PT10,PT15,20,25,27,30	66,50

CHIAVE A BUSSOLA DA 1/4" CON INSERTO PER VITI AD IMPRONTA ESAGONALE

Bussola in acciaio al cromo vanadio e finitura cromata lucida
Inserto fosfatato con finitura brunita



CODICE	mm	L/mm	€/PZ
FG 147/H2.5	2.5	36.0	6,50
FG 147/H3	3	36.0	6,50
FG 147/H4	4	36.0	6,50
FG 147/H5	5	36.0	6,50
FG 147/H6	6	36.0	6,50
FG 147/H7	7	36.0	6,50
FG 147/H8	8	36.0	6,50
FG 147/H10	10	36.0	6,50

SET



SET 8 CHIAVI A BUSSOLA DA 1/4" CON INSERTI PER VITI AD IMPRONTA ESAGONALE

Fornito su supporto in ABS appendibile con ganci a clip e meccanismo finecorsa anticaduta

CODICE	Pz	Contenuto	€/PZ
FG 147H/S8	8	2.5,3,4,5,6,8,10mm	61,00

CHIAVE A BUSSOLA DA 1/4" CON INSERTO PER VITI AD IMPRONTA A CROCE PHILLIPS

Bussola in acciaio al cromo vanadio e finitura cromata lucida
 Inserto fosfatato con finitura brunita



CODICE	PH	L/mm	€/PZ
FG 147/PH1	1	36.0	6,50
FG 147/PH2	2	36.0	6,50
FG 147/PH3	3	36.0	6,50
FG 147/PH4	4	36.0	6,50

CHIAVE A BUSSOLA DA 1/4" CON INSERTO PER VITI CON IMPRONTA A TAGLIO

Bussola in acciaio al cromo vanadio e finitura cromata lucida
 Inserto fosfatato con finitura brunita



CODICE	mm	L/mm	€/PZ
FG 147/SL4	0.8X4.0	36.0	6,50
FG 147/SL5.5	1.0X5.5	36.0	6,50
FG 147/SL6.5	1.2X6.5	36.0	6,50
FG 147/SL8	1.6X8.0	36.0	6,50
FG 147/SL10	1.6X10.0	36.0	6,50



CRICCHETTO REVERSIBILE CON ATTACCO QUADRO MASCHIO 1/4" A 72 DENTI

Sistema di inversione a ghiera integrato sulla testa
 Meccanismo a 72 denti
 Finitura cromata lucida
 Appendibile tramite apposito gancio



CODICE		€/PZ
FG 624/CR14	1/4"	40,00

CRICCHETTO REVERSIBILE CON ATTACCO QUADRO MASCHIO 1/4" A 60 DENTI ED IMPUGNATURA ROTANTE

Meccanismo di rotazione dell'impugnatura che fa ruotare la bussola con il minimo sforzo anche negli spazi più ristretti
 Sistema di inversione a ghiera integrato sulla testa
 Meccanismo a 60 denti
 Finitura cromata lucida
 Quadro maschio scorrevole per serraggi destrorsi e sinistrosi



CODICE		€/PZ
FG 624/RT14	1/4"	65,00

CRICCHETTO REVERSIBILE CON ATTACCO QUADRO MASCHIO 1/4" A 72 DENTI

Testa sigillata per la massima protezione dalla polvere
 Inversione a leva integrata a filo testa
 Corpo scavato di 13° per consentire l'utilizzo anche in spazi ristretti
 Meccanismo a 72 denti
 Finitura cromata lucida
 Appendibile tramite apposito gancio



CODICE		€/PZ
FG 624/FR14	1/4"	43,50

MINI CRICCHETTO CON ATTACCO QUADRO FEMMINA 1/4" A 72 DENTI

Design compatto: lungo solo 80mm



CODICE		€/PZ
FG 624/MCR	1/4"	36,00

MINI CRICCHETTO CON ATTACCO FEMMINA 1/4" PER INSERTI CON IMPRONTA ESAGONALE

Design compatto: lungo solo 80mm



CODICE		€/PZ
FG 624/MCH	1/4"	36,00

QUADRO MASCHIO SNODATO 1/4"

Acciaio al cromo vanadio
 Finitura lucida



CODICE	L/mm	€/PZ
FG 624/Q14	380	39,50

QUADRO MASCHIO SCORREVOLE 1/4"

Acciaio al cromo vanadio
 Finitura lucida



CODICE	L/mm	€/PZ
FG 624/ES14	115	7,50

QUADRO MASCHIO 1/4" SNODATO CON IMPUGNATURA

Impugnatura ergonomica con scanalature anti-scivolo
Acciaio al cromo vanadio
Finitura lucida



CODICE	L/mm	€/PZ
FG 624/CS14	160	27,00

QUADRO MASCHIO 1/4" CON IMPUGNATURA

Impugnatura ergonomica con scanalature anti-scivolo
Acciaio al cromo vanadio
Finitura lucida



CODICE	Flessibile L/mm	€/PZ
FG 624/GR14B	291.6	16,00
FG 624/GR14C	246.6	11,00

PROLUNGA CON ATTACCO QUADRO MASCHIO E FEMMINA 1/4" ANGOLARE

Quadro maschio angolare che permette l'inclinazione fino a 8° rispetto all'asse della bussola
Acciaio al cromo vanadio
Finitura lucida



CODICE	L/mm	€/PZ
FG 624/PA50	50	8,50
FG 624/PA100	100	9,00

PROLUNGA CON ATTACCO QUADRO MASCHIO E FEMMINA 1/4"

Acciaio al cromo vanadio
Finitura lucida



CODICE	L/mm	€/PZ
FG 624/PR50	50	7,50
FG 624/PR100	100	8,00
FG 624/PR150	150	8,50

PROLUNGA CON ATTACCO QUADRO MASCHIO E FEMMINA 1/4" FLESSIBILE

Acciaio al cromo vanadio
Finitura lucida



CODICE	L/mm	€/PZ
FG 624/PRF150	150	12,50

SNODO CON ATTACCO QUADRO MASCHIO E FEMMINA 1/4"

Acciaio al cromo vanadio
Finitura lucida



CODICE	L/mm	€/PZ
FG 624/SN14	38	15,50



CHIAVE A BUSSOLA ESAGONALE - ATTACCO 3/8"

Acciaio al cromo vanadio
Finitura cromata lucida



CODICE	mm	A/mm	B/mm	D/mm	E/mm	€/PZ
FG 624/B8	8	12.2	20.0	32.0	5.0	6,00
FG 624/B9	9	13.5	20.0	32.0	5.0	6,00
FG 624/B10	10	14.7	20.0	32.0	6.0	6,00
FG 624/B11	11	16.0	20.0	32.0	7.0	6,00
FG 624/B12	12	17.2	20.0	32.0	8.0	6,00
FG 624/B13	13	18.5	20.0	32.0	8.0	6,00
FG 624/B14	14	19.8	20.0	32.0	10.0	6,00
FG 624/B15	15	21.0	21.0	35.0	10.0	6,00
FG 624/B16	16	22.2	23.0	35.0	10.0	6,50
FG 624/B17	17	23.8	24.0	35.0	10.0	6,50
FG 624/B18	18	24.8	24.0	35.0	12.0	6,50
FG 624/B19	19	26.0	24.0	35.0	12.0	7,50
FG 624/B21	21	28.5	27.0	35.0	12.0	7,50
FG 624/B22	22	29.7	28.0	38.0	14.0	7,50
FG 624/B23	23	31.5	28.8	38.0	14.0	7,50

SET



SET 15 CHIAVI A BUSSOLA ESAGONALI - ATTACCO 3/8"

Fornito su supporto in ABS appendibile con ganci a clip e meccanismo finecorsa anticaduta

CODICE	Pz	Contenuto	€/PZ
FG 624B/S15	15	8,9,10,11,12,13,14,15,16,17,18,19,21,22,23mm	118,50



SET 15 CHIAVI A BUSSOLA ESAGONALI CON CRICCHETTO - ATTACCO 3/8"

Fornito su supporto in ABS appendibile con ganci a clip e meccanismo finecorsa anticaduta

CODICE	Pz	Contenuto	€/PZ
FG 624B/S16	16	8,9,10,11,12,13,14,15,16,17,18,19,21,22,23mm FG 624/CR38	157,00

SET 22 UTENSILI - ATTACCO 3/8"

Fornito in box di ABS



CODICE	Pz	€/PZ
FG 624B/S22	22	230,00

CONTENUTO

	FG 624/B	8,9,10,11,12,13,14,15,16,17,18,19,21,22,23mm
	FG 624/CR38	
	FG 624B/PA	75,125,150,250mm
	FG 624/ES38	
	FG 624/SN38	

CHIAVE A BUSSOLA ESAGONALE LUNGA - ATTACCO 3/8"

Acciaio al cromo vanadio
Finitura cromata lucida



CODICE	mm	A/mm	B/mm	D/mm	E/mm	€/PZ
FG 624B/L8	8	12.2	17.5	7.1	54.0	10,80
FG 624B/L9	9	13.2	17.5	7.1	54.0	10,80
FG 624B/L10	10	14.8	17.5	7.9	54.0	10,80
FG 624B/L11	11	16.2	17.5	9.7	54.0	10,80
FG 624B/L12	12	17.5	17.5	9.9	54.0	10,80
FG 624B/L13	13	17.8	17.8	10.7	54.0	10,80
FG 624B/L14	14	19.8	18.6	10.7	61.0	10,80
FG 624B/L15	15	20.3	19.5	10.7	61.0	12,00
FG 624B/L16	16	21.8	20.2	10.7	61.0	12,00
FG 624B/L17	17	23.8	21.8	11.2	67.0	12,00
FG 624B/L18	18	24.8	23.5	11.2	67.0	12,00
FG 624B/L19	19	25.8	24.0	12.2	67.9	12,00
FG 624B/L21	21	27.8	26.4	12.4	67.0	14,00
FG 624B/L22	22	29.8	27.2	13.0	73.0	14,00
FG 624B/L23	23	31.5	28.8	13.2	73.0	14,00

SET



SET 15 CHIAVI A BUSSOLA ESAGONALI LUNGHE - ATTACCO 3/8"

Fornito su supporto in ABS appendibile con ganci a clip e meccanismo finecorsa anticaduta

CODICE	Pz	Contenuto	€/PZ
FG 624L/S15	15	8,9,10,11,12,13,14,15,16,17,18,19,21,22,23mm	185,50



SET 15 CHIAVI A BUSSOLA ESAGONALI LUNGHE CON CRICCHETTO - ATTACCO 3/8"

Fornito su supporto in ABS appendibile con ganci a clip e meccanismo finecorsa anticaduta

CODICE	Pz	Contenuto	€/PZ
FG 624L/S16	16	8,9,10,11,12,13,14,15,16,17,18,19,21,22,23mm FG 624/CR38	227,00





SET 20 UTENSILI - ATTACCO 3/8"

Fornito in box di ABS

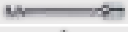
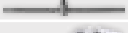

CODICE	Pz	€/PZ
FG 624B/LS20	20	319,50

CONTENUTO

	FG 624B/L	8,9,10,11,12,13,14,15,16,17,18,19,21,22,23mm
	FG 624/CR38	
	FG 624B/PA	75,125,150,250mm
	FG 624/ES38	
	FG 624/SN38	

CHIAVE A BUSSOLA POLIGONALE - ATTACCO 3/8"

Utilizzabile con bulloni esagonali e poligonal
Acciaio al cromo vanadio
Finitura cromata lucida



CODICE	mm	A/mm	B/mm	D/mm	E/mm	€/PZ
FG 624/C6	6	12.2	20.0	32.0	5.0	5,00
FG 624/C7	7	13.5	20.0	32.0	5.0	5,00
FG 624/C8	8	12.2	20.0	32.0	5.0	5,00
FG 624/C9	9	13.5	20.0	32.0	5.0	5,00
FG 624/C10	10	14.7	20.0	32.0	6.0	5,00
FG 624/C11	11	16.0	20.0	32.0	7.0	5,00
FG 624/C12	12	17.2	20.0	32.0	8.0	5,00
FG 624/C13	13	18.5	20.0	32.0	8.0	5,00
FG 624/C14	14	19.8	20.0	32.0	10.0	5,00
FG 624/C15	15	21.0	21.0	35.0	10.0	5,50
FG 624/C16	16	22.2	23.0	35.0	10.0	5,50
FG 624/C17	17	23.8	24.0	35.0	10.0	5,50
FG 624/C18	18	24.8	24.0	35.0	12.0	5,50
FG 624/C19	19	26.0	24.0	35.0	12.0	5,50
FG 624/C20	20	26.0	24.0	35.0	12.0	5,50
FG 624/C21	21	28.5	27.0	35.0	12.0	6,00
FG 624/C22	22	29.7	28.0	38.0	14.0	6,00
FG 624/C24	24	31.5	28.8	38.0	14.0	6,50

SET



SET 18 CHIAVI A BUSSOLA POLIGONALI - ATTACCO 3/8"

Fornito su supporto in ABS appendibile con ganci a clip e meccanismo finecorsa anticaduta

CODICE	Pz	Contenuto	€/PZ
FG 624C/S18	18	6,7,8,9,10,11,12,13,14,15,16,17,18,19,20,21,22,24mm	108,50



SET 22 UTENSILI - ATTACCO 3/8"

Fornito in box di ABS



CODICE	Pz	€/PZ
FG 624C/S22	22	216,50

CONTENUTO

	FG 624/C	8,9,10,11,12,13,14,15,16,17,18,19,21mm
	FG 624/CR38	
	FG 624B/PA	75,125,150,250
	FG 624/ES38	
	FG 624/SN38	



FASANO[®]
TOOLS

CHIAVE A BUSSOLA POLIGONALE LUNGA - ATTACCO 3/8"

Utilizzabile con bulloni esagonali e poligonali

Acciaio al cromo vanadio

Finitura cromata lucida



CODICE	mm	A/mm	B/mm	D/mm	E/mm	€/PZ
FG 624/L6	6	12.2	17.5	7.1	54.0	8,50
FG 624/L7	7	13.2	17.5	7.1	54.0	8,50
FG 624/L8	8	12.2	17.5	7.1	54.0	8,50
FG 624/L9	9	13.2	17.5	7.1	54.0	8,50
FG 624/L10	10	14.8	17.5	7.9	54.0	8,50
FG 624/L11	11	16.2	17.5	9.7	54.0	8,50
FG 624/L12	12	17.5	17.5	9.9	54.0	8,50
FG 624/L13	13	17.8	17.8	10.7	54.0	8,50
FG 624/L14	14	19.8	18.6	10.7	61.0	9,20
FG 624/L15	15	20.3	19.5	10.7	61.0	11,00
FG 624/L16	16	21.8	20.2	10.7	61.0	11,00
FG 624/L17	17	23.8	21.8	11.2	67.0	11,50
FG 624/L18	18	24.8	23.5	11.2	67.0	12,00
FG 624/L19	19	25.8	24.0	12.2	67.9	12,00
FG 624/L20	20	26.0	26.4	12.4	67.0	12,50
FG 624/L21	21	27.8	26.4	12.4	67.0	12,50
FG 624/L22	22	29.8	27.2	13.0	73.0	13,00
FG 624/L24	24	31.5	28.8	13.2	73.0	13,50

SET



SET 18 CHIAVI A BUSSOLA POLIGONALI LUNGHE - ATTACCO 3/8"

Fornito su supporto in ABS appendibile con ganci a clip e meccanismo finecorsa anticaduta

CODICE	Pz	Contenuto	€/PZ
FG 624L/S18	18	6, 7, 8, 9, 10, 11, 12, 13, 14, 15, 16, 17, 18, 19, 20, 21, 22, 24mm	204,00

SET 20 UTENSILI - ATTACCO 3/8"

Fornito in box di ABS



CODICE	Pz	€/PZ
FG 624L/S20	20	278,50

CONTENUTO

	FG 624/L	8,9,10,11,12,13,14,15,16,17,18,19,21mm
	FG 624/CR38	
	FG 624B/PA	75,125,150,250
	FG 624/ES38	
	FG 624/SN38	

CHIAVE A BUSSOLA POLIGONALE IN POLLICI - ATTACCO 3/8"

Acciaio al cromo vanadio
Finitura cromata lucida



CODICE	"	A/mm	B/mm	D/mm	E/mm	€/PZ
FG 624C/IN1	1/4	12.2	20.0	32.0	5.0	5,50
FG 624C/IN2	5/16	12.2	20.0	32.0	5.0	5,50
FG 624C/IN3	11/32	13.5	20.0	32.0	5.0	5,50
FG 624C/IN4	3/8	14.7	20.0	32.0	6.0	5,50
FG 624C/IN5	7/16	16.0	20.0	32.0	7.0	5,50
FG 624C/IN6	15/32	17.2	20.0	32.0	8.0	6,00
FG 624C/IN7	1/2	18.5	20.0	32.0	8.0	6,00
FG 624C/IN8	9/16	19.8	20.0	32.0	10.0	6,00
FG 624C/IN9	19/32	21.0	21.0	35.0	10.0	6,50
FG 624C/IN10	5/8	22.0	23.0	35.0	10.0	6,50
FG 624C/IN11	11/16	23.8	24.0	35.0	10.0	6,50
FG 624C/IN12	3/4	26.0	24.0	35.0	12.0	7,00
FG 624C/IN13	25/32	26.0	24.0	35.0	12.0	7,00
FG 624C/IN14	13/16	28.5	27.0	35.0	12.0	7,50
FG 624C/IN15	7/8	29.7	28.0	38.0	14.0	8,20
FG 624C/IN16	15/16	31.5	28.8	38.0	14.0	8,60

SET



SET 13 CHIAVI A BUSSOLA POLIGONALI IN POLLICI - ATTACCO 3/8"

Fornito su supporto in ABS appendibile con ganci a clip e meccanismo finecorsa anticaduta

CODICE	Pz	Contenuto"	€/PZ
FG 624C/INS13	13	1/4,5/16,11/32,3/8,7/16,1/2,9/16,19/32,5/8,11/16,3/4,13/16,7/8	90,00

SET 23 UTENSILI - ATTACCO 3/8"

Fornito in box di ABS



CODICE	Pz	€/PZ
FG 624C/INS23	23	237,00

CONTENUTO

	FG 624C/IN	1/4", 5/16", 11/32", 3/8", 7/16", 15/32", 1/2", 9/16", 19/32", 5/8", 11/16", 3/4", 25/32", 13/16", 7/8", 15/16"
	FG 624/CR38	
	FG 624B/PA	75,125,150,250
	FG 624/ES38	
	FG 624/SN38	



CHIAVI A BUSSOLA TORX - ATTACCO 3/8"

Acciaio al cromo vanadio
Finitura cromata lucida



CODICE	mm	A/mm	B/mm	E/mm	L/mm	€/PZ
FG 624B/TX5	5	16.8	9.3	10.5	28.0	7,00
FG 624B/TX6	6	16.8	9.3	10.5	28.0	7,00
FG 624B/TX7	7	16.9	11.7	10.7	28.0	7,00
FG 624B/TX8	8	16.9	11.7	10.7	28.0	7,00
FG 624B/TX10	10	16.9	14.5	10.8	28.0	7,00
FG 624B/TX12	12	19.8	17.0	14.0	32.0	7,00
FG 624B/TX14	14	19.8	17.5	14.0	32.0	7,00
FG 624B/TX16	16	19.8	17.0	14.0	32.0	7,00

SET



SET 8 CHIAVI A BUSSOLA TORX - ATTACCO 3/8"

Fornito su supporto in ABS appendibile con ganci a clip e meccanismo finecorsa anticaduta

CODICE	Pz	Contenuto	€/PZ
FG 624TX/S8	8	5,6,7,8,10,12,14,16 E	62,00

CHIAVE A BUSSOLA TORX LUNGA - ATTACCO 3/8"

Acciaio al cromo vanadio
Finitura cromata lucida



CODICE	mm	A/mm	B/mm	L/mm	€/PZ
FG 624L/TX6	6	16.8	10.0	63.0	11,00
FG 624L/TX7	7	16.8	10.9	63.0	11,00
FG 624L/TX8	8	16.8	12.0	63.0	11,00
FG 624L/TX10	10	16.8	14.9	63.0	11,00
FG 624L/TX12	12	16.8	15.8	63.0	11,00
FG 624L/TX14	14	16.8	16.8	63.0	11,00
FG 624L/TX16	16	17.8	17.8	63.0	11,00
FG 624L/TX18	18	17.8	19.8	63.0	11,00

SET



SET 8 CHIAVI A BUSSOLA TORX LUNGHE - ATTACCO 3/8"

Fornito su supporto in ABS appendibile con ganci a clip e meccanismo finecorsa anticaduta

CODICE	Pz	Contenuto	€/PZ
FG 624L/TXS8	8	6,7,8,10,12,14,16,18 E	95,00

SET



SET 10 CHIAVI A BUSSOLA TORX EXTRA LUNGHE - ATTACCO 3/8"

Fornito in box di ABS

CODICE	Pz	Contenuto	€/PZ
FG 624B/TXS10	10	E6, E7, E8, E10, E11, E12, E14, E16, E18, E20	135,00



FASANO
TOOLS

CHIAVE A BUSSOLA DA 3/8" CON INSERTO PER VITI AD IMPRONTA TORX

Bussola in acciaio al cromo vanadio e finitura cromata lucida
Inserto fosfatato con finitura brunita



CODICE	TX	L/mm	€/PZ
FG 149/TX9	9	50.0	11,50
FG 149/TX10	10	50.0	11,50
FG 149/TX15	15	50.0	11,50
FG 149/TX20	20	50.0	11,50
FG 149/TX25	25	50.0	11,50
FG 149/TX27	27	50.0	11,50
FG 149/TX30	30	50.0	11,50
FG 149/TX40	40	50.0	11,50

SET



SET 8 CHIAVI A BUSSOLA DA 3/8" CON INSERTI PER VITI AD IMPRONTA TORX

Fornito su supporto in ABS appendibile con ganci a clip e meccanismo finecorsa anticaduta

CODICE	Pz	Contenuto	€/PZ
FG 149TX/S8	8	TX9, TX10, TX15, TX20, TX25, TX27, TX30, TX40	94,50



SET 8 CHIAVI A BUSSOLA DA 3/8" CON INSERTI PER VITI AD IMPRONTA TORX

Fornito in box di ABS compatto

CODICE	Pz	Contenuto	€/PZ
FG 149TX/S8B	8	TX9, TX10, TX15, TX20, TX25, TX27, TX30, TX40	100,00

CHIAVE A BUSSOLA DA 3/8" CON INSERTO PER VITI AD IMPRONTA ESAGONALE

Bussola in acciaio al cromo vanadio e finitura cromata lucida
Inserto fosfatato con finitura brunita



CODICE	mm	L/mm	€/PZ
FG 149/H3	3	50.0	7,00
FG 149/H4	4	50.0	7,00
FG 149/H5	5	50.0	7,00
FG 149/H6	6	50.0	7,00
FG 149/H7	7	50.0	7,00
FG 149/H8	8	50.0	7,00
FG 149/H10	10	50.0	7,00

SET



SET 7 CHIAVI A BUSSOLA DA 3/8" CON INSERTO PER VITI AD IMPRONTA ESAGONALE

Fornito su supporto in ABS appendibile con ganci a clip e meccanismo finecorsa anticaduta

CODICE	Pz	Contenuto	€/PZ
FG 149H/S7	7	3,4,5,6,7,8,10	55,00

CHIAVE A BUSSOLA DA 3/8" CON INSERTO PER VITI AD IMPRONTA PENTALOBATA

Bussola in acciaio al cromo vanadio e finitura cromata lucida
Inserto fosfatato con finitura brunita



CODICE	PT	L/mm	€/PZ
FG 149/PT40	40	50.0	10,00
FG 149/PT45	45	50.0	10,00
FG 149/PT50	50	50.0	10,00



CHIAVE A BUSSOLA DA 3/8" CON INSERTO PER VITI CON IMPRONTA A TAGLIO

Bussola in acciaio al cromo vanadio e finitura cromata lucida
Inserto fosfatato con finitura brunita



CODICE	mm	L/mm	€/PZ
FG 149/SL5.5	1.0X5.5	50.0	7,00
FG 149/SL6.5	1.2X6.5	50.0	7,00
FG 149/SL8	1.6X8.0	50.0	7,00
FG 149/SL10	1.6X10.0	50.0	7,00

CHIAVE A BUSSOLA DA 3/8" CON INSERTO PER VITI AD IMPRONTA A CROCE PHILLIPS

Bussola in acciaio al Cromo Vanadio
Inserto fosfatato in materiale S2



CODICE	PH	L/mm	€/PZ
FG 149/PH1	1	50.0	7,00
FG 149/PH2	2	50.0	7,00
FG 149/PH3	3	50.0	7,00
FG 149/PH4	4	50.0	7,00



SET 8 CHIAVI A BUSSOLA DA 3/8" CON INSERTO PER VITI AD IMPRONTA A CROCE PHILLIPS ED A TAGLIO

Fornito in box di ABS compatto

CODICE	Pz	€/PZ
FG 149PF/S8	8	59,00

CRICCHETTO REVERSIBILE CON ATTACCO QUADRO MASCHIO 3/8" A 72 DENTI

Sistema di inversione a ghiera integrato sulla testa
Meccanismo a 72 denti
Finitura cromata lucida
Appendibile tramite apposito gancio



CODICE	■	€/PZ
FG 624/CR38	3/8"	43,50

QUADRO MASCHIO 3/8" SNODATO CON IMPUGNATURA

Impugnatura ergonomica con scanalature anti-scivolo
Acciaio al cromo vanadio
Finitura lucida



CODICE	L/mm	€/PZ
FG 624/CS38	260	34,00

QUADRO MASCHIO SCORREVOLE 3/8"

Acciaio al cromo vanadio
Finitura lucida



CODICE	L/mm	€/PZ
FG 624/ES38	220	13,50

QUADRO MASCHIO SNODATO 3/8"

Acciaio al cromo vanadio
Finitura lucida



CODICE	L/mm	€/PZ
FG 624/Q38	425	43,50

PROLUNGA CON ATTACCO QUADRO MASCHIO E FEMMINA 3/8" ANGOLARE

Quadro maschio angolare che permette l'inclinazione fino a 8° rispetto all'asse della bussola

Acciaio al cromo vanadio
Finitura lucida



CODICE	L/mm	€/PZ
FG 624B/PA75	75	10,50
FG 624B/PA125	125	11,50
FG 624B/PA150	150	15,00
FG 624B/PA250	250	20,50

SNODO CON ATTACCO QUADRO MASCHIO E FEMMINA 3/8"

Acciaio al cromo vanadio
Finitura lucida



CODICE	L/mm	€/PZ
FG 624/SN38	52	15,00

SET 80 UTENSILI - ATTACCO 3/8"

Fornito in box di ABS con clip di chiusura in acciaio



CODICE	Pz	€/PZ
FG 624B/S80	80	200,00

CONTENUTO

	FG 624/B	8,9,10,11,12,13,14,15,16,17,18,19,21,22,23
	FG 624B/L	8,10,13,17,19
	FG 624/CR38	
	FG 625/SN38	
	FG 149/H	3,4,5,6,7,8,10
	FG 149/TX	9,10,15,20,25,27,30,40
	FG 624/ES38	
	FG 624B/PA	75,125,150,250
	FG 600/B8	8,10,13,15,17,19
	FG 89/50PI2	3/8"x1/4"
	FG 85/25PH	1,2,3
	FG 85/25PZ	1,2,3
	FG 85/25SL	3,4,4,5,5,5,5,6,6,5
	FG 85/H	1,5,2,2,5,3,4,5,6
	FG 85/25T	9,10,15,20,25,27,30,40
	FG 88/60PI2	



CHIAVE A BUSSOLA ESAGONALE - ATTACCO 1/2"

Acciaio al cromo vanadio
Finitura cromata lucida



CODICE	mm	A/mm	B/mm	D/mm	E/mm	€/PZ
FG 625/A8	8	14.9	21.8	38.1	7.5	5,50
FG 625/A9	9	16.5	21.8	38.1	8.0	5,50
FG 625/A10	10	14.9	21.8	38.1	7.5	5,50
FG 625/A11	11	16.5	21.8	38.1	8.0	5,50
FG 625/A12	12	18.2	21.8	38.1	9.1	5,50
FG 625/A13	13	19.0	21.8	38.1	9.1	5,50
FG 625/A14	14	20.5	21.8	38.1	10.7	5,50
FG 625/A15	15	22.2	22.6	38.1	10.7	5,50
FG 625/A16	16	23.8	22.6	38.1	10.7	5,50
FG 625/A17	17	24.5	22.9	38.1	12.7	5,50
FG 625/A18	18	25.4	23.7	38.1	13.9	6,50
FG 625/A19	19	26.3	24.8	38.1	14.0	6,50
FG 625/A20	20	27.1	26.1	38.1	14.0	7,00
FG 625/A21	21	28.3	27.5	38.1	14.0	7,00
FG 625/A22	22	29.9	28.6	38.1	14.2	8,50
FG 625/A23	23	31.2	29.9	38.1	14.5	9,00
FG 625/A24	24	32.5	31.0	38.1	15.5	9,00
FG 625/A25	25	33.3	32.6	38.1	15.5	9,50
FG 625/A26	26	34.6	33.4	41.3	16.0	9,50
FG 625/A27	27	36.5	34.9	44.5	19.6	9,50
FG 625/A30	30	41.0	39.6	44.5	19.6	9,50
FG 625/A32	32	42.5	41.2	47.6	19.6	10,00

SET



SET CHIAVI A BUSSOLA ESAGONALI - ATTACCO 1/2"

Fornito su supporto in ABS appendibile con ganci a clip e meccanismo finecorsa anticaduta

CODICE	Pz	Contenuto	€/PZ
FG 625A/S11	11	8,10,11,12,13,14,15,16,17,18,19	80,50
FG 625A/S10	10	20,21,22,23,24,25,26,27,30,32	101,00



SET 11 CHIAVI A BUSSOLA ESAGONALI CON CRICCHETTO - ATTACCO 1/2"

Fornito su supporto in ABS appendibile con ganci a clip e meccanismo finecorsa anticaduta

CODICE	Pz	Contenuto	€/PZ
FG 625A/S12	12	8,10,11,12,13,14,15,16,17,18,19mm FG 625/CR12	134,00

SET 25 UTENSILI - ATTACCO 1/2"

Fornito in box di ABS



CODICE	Pz	€/PZ
FG 625A/S25	25	278,50

CONTENUTO

	FG 625/A	10,11,12,13,14,15,16,17,18,19,20,21,22,23,24,25,26,27,30,32mm
	FG 625/CR12	
	FG 625/PA	125, 250
	FG 625/ES12	
	FG 625/SN12	

CHIAVE A BUSSOLA ESAGONALE LUNGA - ATTACCO 1/2"

Acciaio al cromo vanadio
Finitura cromata lucida



CODICE	mm	A/mm	B/mm	C/mm	L/mm	€/PZ
FG 625L/A10	10	15.4	22.0	20.0	76.8	13,50
FG 625L/A11	11	16.4	22.0	18.0	77.0	13,50
FG 625L/A12	12	18.0	22.0	20.0	76.8	13,50
FG 625L/A13	13	19.0	22.0	19.4	77.0	13,50
FG 625L/A14	14	20.4	22.0	32.7	77.0	13,50
FG 625L/A15	15	21.9	20.9	34.0	76.3	13,50
FG 625L/A16	16	22	20.3	31.8	76.7	14,00
FG 625L/A17	17	24.0	22.0	31.5	77.0	14,00
FG 625L/A18	18	26.0	23.0	35.8	77.4	14,00
FG 625L/A19	19	26.0	24.0	31.0	77.0	14,00
FG 625L/A20	20	27.7	26.5	23.0	79.7	15,00
FG 625L/A21	21	27.8	26.0	31.7	77.0	15,00
FG 625L/A22	22	29.8	26.0	33.0	77.0	17,00
FG 625L/A23	23	31.5	28.8	23.6	72.9	19,00
FG 625L/A24	24	31.8	28.0	33.0	77.0	20,00
FG 625L/A25	25	33.2	31.7	23.4	80.2	20,00
FG 625L/A26	26	35.0	33.2	24	80.2	20,00
FG 625L/A27	27	35.8	31.0	31.5	77.1	23,00
FG 625L/A28	28	37.5	35.6	24	80.2	26,00
FG 625L/A29	29	37.8	34.0	31.4	77.0	26,00
FG 625L/A30	30	39.7	34.0	31.7	77.0	27,00
FG 625L/A32	32	43.0	40.9	27.3	80.0	27,00
FG 625L/A36	36	48.0	40.0	35.0	78.0	45,50

SET



SET CHIAVI A BUSSOLA ESAGONALI LUNGHE - ATTACCO 1/2"

Fornito su supporto in ABS appendibile con ganci a clip e meccanismo finecorsa anticaduta

CODICE	Pz	Contenuto	€/PZ
FG 625AL/S11	11	10,12,13,14,15,16,17,18,19,21,22mm	165,00
FG 625AL/S9	9	23,24,25,26,27,28,29,30,32mm	216,50

SET 37 UTENSILI - ATTACCO 1/2"

Fornito in box di ABS



CODICE	Pz	€/PZ
FG 625A/S37	37	489,50

CONTENUTO

	FG 625/A	8,9,10,11,12,13,14,15,16,17,18,19,20,21,22,23,24,26,27,30,32mm
	FG 625/L/A	10,12,13,14,17,19,21,22,24,27,30mm
	FG 625/CR12	
	FG 625/PA	125,250
	FG 625/ES12	
	FG 625/SN12	



CHIAVE A BUSSOLA POLIGONALE - ATTACCO 1/2"

Utilizzabile con bulloni esagonali e poligonal
Acciaio al cromo vanadio
Finitura cromata lucida



CODICE	mm	A/mm	B/mm	D/mm	E/mm	€/PZ
FG 625/C8	8	14.9	21.8	38.1	7.5	5,50
FG 625/C10	10	14.9	21.8	38.1	7.5	5,50
FG 625/C11	11	16.5	21.8	38.1	8.0	5,50
FG 625/C12	12	18.2	21.8	38.1	9.1	5,50
FG 625/C13	13	19.0	21.8	38.1	9.1	5,50
FG 625/C14	14	20.5	21.8	38.1	10.7	5,50
FG 625/C15	15	22.2	22.6	38.1	10.7	5,50
FG 625/C16	16	23.8	22.6	38.1	10.7	5,50
FG 625/C17	17	24.5	22.9	38.1	12.7	5,50
FG 625/C18	18	25.4	23.7	38.1	13.9	6,50
FG 625/C19	19	26.3	24.8	38.1	14.0	6,50
FG 625/C20	20	27.1	26.1	38.1	14.0	7,00
FG 625/C21	21	28.3	27.5	38.1	14.0	7,00
FG 625/C22	22	29.9	28.6	38.1	14.2	8,50
FG 625/C23	23	31.2	29.9	38.1	14.5	9,00
FG 625/C24	24	32.5	31.0	38.1	15.5	9,00
FG 625/C25	25	33.3	32.6	38.1	15.5	9,50
FG 625/C26	26	34.6	33.4	41.3	16.0	9,50
FG 625/C27	27	36.5	34.9	44.5	19.6	9,50
FG 625/C28	28	41.0	39.6	44.5	19.6	9,50
FG 625/C29	29	42.5	41.2	47.5	19.6	9,50
FG 625/C30	30	41.0	39.6	44.5	19.6	9,50
FG 625/C32	32	42.5	41.2	47.6	19.6	10,00

SET



SET CHIAVI A BUSSOLA POLIGONALI - ATTACCO 1/2"

Fornito su supporto in ABS appendibile con ganci a clip e meccanismo finecorsa anticaduta

CODICE	Pz	Contenuto	€/PZ
FG 625/S11	11	8,10,11,12,13,14,15,16,17,18,19	77,50
FG 625/S12B	12	20,21,22,23,24,25,26,27,28,29,30,32mm	95,00



SET 11 CHIAVI A BUSSOLA POLIGONALI CON CRICCHETTO - ATTACCO 1/2"

Fornito su supporto in ABS appendibile con ganci a clip e meccanismo finecorsa anticaduta

CODICE	Pz	Contenuto	€/PZ
FG 625/S12	12	8,10,11,12,13,14,15,16,17,18,19mm FG 625/CR12	124,00

SET 25 UTENSILI - ATTACCO 1/2"

Fornito in box di ABS



CODICE	Pz	€/PZ
FG 625C/S25	25	264,00

CONTENUTO

	FG 625/C	10,11,12,13,14,15,16,17,18,19,20,21,22,23,24,25,26,27,30,32mm
	FG 625/CR12	
	FG 625/PA	125,250
	FG 625/ES12	
	FG 625/SN12	

CHIAVE A BUSSOLA POLIGONALE LUNGA - ATTACCO 1/2"

Utilizzabile con bulloni esagonali e poligonali
Acciaio al cromo vanadio
Finitura cromata lucida



CODICE	mm	A/mm	B/mm	C/mm	L/mm	€/PZ
FG 625/L8	8	13.0	21.9	16.7	77.0	10,50
FG 625/L9	9	14.0	21.9	17	77.0	10,50
FG 625/L10	10	15.5	21.9	19.5	77.0	10,50
FG 625/L11	11	16.5	21.9	17.6	77.0	10,50
FG 625/L12	12	17.7	21.9	19	77.0	10,50
FG 625/L13	13	19.0	21.9	19	77.0	10,50
FG 625/L14	14	20.4	21.9	33	77.0	10,50
FG 625/L15	15	21.9	20.5	31.5	77.0	10,50
FG 625/L16	16	22.0	20.5	31.7	77.0	10,50
FG 625/L17	17	23.9	22.0	32.0	77.0	10,50
FG 625/L18	18	26.0	23.0	31.0	77.0	11,00
FG 625/L19	19	26.0	24	35.6	77.0	11,00
FG 625/L20	20	27.7	25.7	31.6	77.0	12,50
FG 625/L21	21	27.6	26.0	35.5	77.0	13,50
FG 625/L22	22	29.7	26.0	32.0	77.0	15,00
FG 625/L23	23	31.8	27.7	31.0	77.0	15,00
FG 625/L24	24	31.8	28.0	32.4	77.0	15,00
FG 625/L25	25	33.8	29.7	31.6	77.0	17,00
FG 625/L27	27	35.8	30.7	31.3	77.0	20,00
FG 625/L30	30	39.8	33.8	31.3	77.0	25,50
FG 625/L32	32	42.0	35.0	31.6	77.0	26,50
FG 625/L36	36	48.0	40.0	35.0	77.5	45,50

SET



SET CHIAVI A BUSSOLA POLIGONALI LUNGHE - ATTACCO 1/2"

Fornito su supporto in ABS appendibile con ganci a clip e meccanismo finecorsa anticaduta

CODICE	Pz	Contenuto	€/PZ
FG 625L/S12	12	8,9,10,11,12,13,14,15,16,17,18,19mm	136,00
FG 625L/S6	6	21,22,24,27,30,32mm	124,00

SET 37 UTENSILI - ATTACCO 1/2"

Fornito in box di ABS



CODICE	Pz	€/PZ
FG 625/S37	37	465,00

CONTENUTO

	FG 625/C	8,9,10,11,12,13,14,15,16,17,18,19,20,21,22,23,24,26,27,30,32mm
	FG 625/L	10,12,13,14,17,19,21,22,24,27,30mm
	FG 625/CR12	
	FG 625/PA125,250	
	FG 625/ES12	
	FG 625/SN12	



CHIAVE A BUSSOLA POLIGONALE IN POLLICI - ATTACCO 1/2"

Acciaio al cromo vanadio
Finitura cromata lucida



CODICE	Pollici	A/mm	B/mm	D/mm	E/mm	€/PZ
FG 625C/IN1	5/16	14.9	21.8	38.1	7.5	5,50
FG 625C/IN2	3/8	14.9	21.8	38.1	7.5	5,50
FG 625C/IN3	7/16	16.5	21.8	38.1	8.0	5,50
FG 625C/IN4	15/32	18.2	21.8	38.1	9.1	5,50
FG 625C/IN5	1/2	19.0	21.8	38.1	10.7	5,50
FG 625C/IN6	9/16	20.5	21.8	38.1	10.7	5,50
FG 625C/IN7	19/32	22.2	22.6	38.1	10.7	5,50
FG 625C/IN8	5/8	23.8	22.6	38.1	12.7	5,50
FG 625C/IN9	11/16	24.5	22.9	38.1	12.7	5,50
FG 625C/IN10	3/4	26.3	24.8	38.1	14.0	6,50
FG 625C/IN11	25/32	27.1	26.12	38.1	14.0	7,00
FG 625C/IN12	13/16	28.3	27.5	38.1	14.0	7,20
FG 625C/IN13	7/8	29.9	28.6	38.1	14.2	8,70
FG 625C/IN14	15/16	32.5	31.0	38.1	15.5	9,50
FG 625C/IN15	1	33.3	32.6	38.1	15.5	9,80
FG 625C/IN16	1.1/16	36.5	34.9	44.5	19.6	11,20
FG 625C/IN17	1.1/8	36.5	34.9	44.5	19.6	11,20
FG 625C/IN18	1.3/16	41.0	39.6	44.5	19.6	11,50
FG 625C/IN19	1.1/4	42.5	41.2	47.6	19.6	11,50

SET



SET 11 CHIAVI A BUSSOLA POLIGONALI IN POLLICI - ATTACCO 1/2"

Fornito su supporto in ABS appendibile con ganci a clip e meccanismo finecorsa anticaduta

CODICE	Pz	Contenuto	€/PZ
FG 625IN/S11	11	3/8, 7/16, 1/2, 9/16, 5/8, 11/16, 3/4, 13/16, 7/8, 15/16, 1"	75,00



SET 24 UTENSILI - ATTACCO 1/2"

Fornito in box di ABS



CODICE	Pz	€/PZ
FG 625IN/S24	24	270,00

CONTENUTO

	FG 626/A	5/16", 3/8", 7/16", 15/32", 1/2", 9/16", 19/32", 5/8", 11/16", 3/4", 25/32", 13/16", 7/8", 15/16", 1", 1.1/16", 1.1/8", 1.3/16", 1.1/4"
	FG 625/CR12	
	FG 625/PA	125,250
	FG 625/ES12	
	FG 625/SN12	

CHIAVE A BUSSOLA UNIVERSALE - ATTACCO 1/2"

Utilizzabile con bulloni esagonali (sia integri che danneggiati fino al 50%), poligonali, Torx, quadrati e XZN
Acciaio al cromo vanadio
Finitura cromata lucida



CODICE	mm	E	■	B/mm	C/mm	L/mm	€/PZ
FG 626/A8	8	E10		13.5	21.9	38.1	7,00
FG 626/A10	10	E12	8	15.6	21.9	38.1	7,00
FG 626/A11	11	E14		16.7	21.9	38.1	7,00
FG 626/A12	12	E16	10	18.0	21.9	38.1	7,00
FG 626/A13	13	E18	11	19.1	21.9	38.1	7,00
FG 626/A14	14		12	20.8	22.0	38.1	7,00
FG 626/A15	15			23.0	22.0	38.1	7,00
FG 626/A16	16	E20		24.0	22.0	38.1	7,20
FG 626/A17	17		13	24.5	22.0	38.1	7,20
FG 626/A18	18	E22	15	26.0	23.0	38.1	7,20
FG 626/A19	19	E24	16	27.5	24.0	38.1	7,70
FG 626/A20	20			28.5	24.0	38.1	7,70
FG 626/A21	21			28.5	24.0	38.1	7,70
FG 626/A22	22	E28		30.5	24.0	38.1	8,00
FG 626/A23	23		28.5	24.0	38.1		8,50
FG 626/A24	24	E30		32.5	25.0	40.0	8,50
FG 626/A27	27	E32		37.0	28.0	42.0	10,50
FG 626/A30	30		41.8	29.0	45.0		12,00
FG 626/A32	32		43.8	30.0	45.0		13,00

SET



SET CHIAVI A BUSSOLA UNIVERSALI - ATTACCO 1/2"

Fornito su supporto in ABS appendibile con ganci a clip e meccanismo finecorsa anticaduta

CODICE	Pz	Contenuto	€/PZ
FG 626/S13	13	8,10,11,12,13,14,15,16,17,18,19,20,21mm	105,00
FG 626/S6	6	22,23,24,27,30,32mm	65,00

SET 23 UTENSILI - ATTACCO 1/2"

Fornito in box di ABS



CODICE	Pz	€/PZ
FG 626/S23	23	280,00

CONTENUTO

	FG 625C/IN	8,10,11,12,13,14,15,16,17,18,19,20,21,22,24,27,30,32mm
	FG 625/CR12	
	FG 625/PA	125,250
	FG 625/ES12	
	FG 625/SN12	

CHIAVE A BUSSOLA TORX - ATTACCO 1/2"

Acciaio al cromo vanadio
Finitura cromata lucida



CODICE	E	A/mm	B/mm	L/mm	€/PZ
FG 625/TX8	8	21.8	17.8	38.1	8,00
FG 625/TX10	10	21.8	15.4	38.1	8,00
FG 625/TX12	12	21.8	17.8	38.1	8,00
FG 625/TX14	14	21.8	20.4	38.1	8,00
FG 625/TX16	16	21.8	21.8	38.1	8,00
FG 625/TX18	18	21.8	21.8	38.1	8,00
FG 625/TX20	20	22.8	22.8	38.1	8,00
FG 625/TX22	22	24.0	25.8	38.1	8,00
FG 625/TX24	24	26.0	27.8	40.0	8,00

SET



SET 9 CHIAVI A BUSSOLA TORX - ATTACCO 1/2"

Fornito su supporto in ABS appendibile con ganci a clip e meccanismo finecorsa anticaduta

CODICE	Pz	Contenuto	€/PZ
FG 625TX/S9	9	8,10,12,14,16,18,20,22,24E	80,50



CHIAVE A BUSSOLA TORX LUNGA - ATTACCO 1/2"

Acciaio al cromo vanadio
Finitura cromata lucida



CODICE	E	A/mm	B/mm	L/mm	€/PZ
FG 625L/TX8	8	21.8	11.8	77.0	13,50
FG 625L/TX10	10	21.8	15.4	77.0	14,00
FG 625L/TX12	12	21.8	17.8	77.0	14,00
FG 625L/TX14	14	21.8	20.4	77.0	14,00
FG 625L/TX16	16	21.8	21.8	77.0	14,00
FG 625L/TX18	18	21.8	21.8	77.0	14,00
FG 625L/TX20	20	23.8	23.8	77.0	14,00
FG 625L/TX22	22	24.0	25.8	77.0	14,00
FG 625L/TX24	24	26.0	27.8	77.0	14,00

SET



SET 9 CHIAVI A BUSSOLA TORX LUNGHE - ATTACCO 1/2"

Fornito su supporto in ABS appendibile con ganci a clip e meccanismo finecorsa anticaduta

CODICE	Pz	Contenuto	€/PZ
FG 625LTX/S9	9	8,10,12,14,16,18,20,22,24E	134,00



CHIAVE A BUSSOLA DA 1/2" CON INSERTO PER VITI AD IMPRONTA TORX

Bussola in acciaio al cromo vanadio e finitura cromata lucida
Inserto fosfatato con finitura brunita



CODICE	TX	L/mm	€/PZ
FG 150/TX6	6	55	13,50
FG 150/TX7	7	55	13,50
FG 150/TX8	8	55	13,50
FG 150/TX9	9	55	13,50
FG 150/TX10	10	55	13,50
FG 150/TX15	15	55	13,50
FG 150/TX20	20	55	13,50
FG 150/TX25	25	55	13,50
FG 150/TX27	27	55	13,50
FG 150/TX30	30	55	14,00
FG 150/TX40	40	55	14,00
FG 150/TX45	45	55	14,50
FG 150/TX50	50	55	14,50
FG 150/TX55	55	55	16,00
FG 150/TX60	60	55	17,00
FG 150/TX70	70	55	17,00

CHIAVE A BUSSOLA DA 1/2" CON INSERTO LUNGO PER VITI AD IMPRONTA TORX

Bussola in acciaio al cromo vanadio e finitura cromata lucida
Inserto fosfatato con finitura brunita



CODICE	TX	L/mm	€/PZ
FG 150L/TX20	20	100	16,00
FG 150L/TX25	25	100	16,00
FG 150L/TX27	27	100	16,00
FG 150L/TX30	30	100	16,00
FG 150L/TX40	40	100	16,00
FG 150L/TX45	45	100	16,50
FG 150L/TX50	50	100	16,50
FG 150L/TX55	55	100	17,50
FG 150L/TX60	60	100	17,50
FG 150L/TX70	70	100	19,50

CHIAVE A BUSSOLA DA 1/2" CON INSERTO EXTRA LUNGO PER VITI AD IMPRONTA TORX

Bussola in acciaio al cromo vanadio e finitura cromata lucida
 Inserto fosfatato con finitura brunita



CODICE	TX	L/mm	€/PZ
FG 150XL/TX40	40	140	19,50
FG 150XL/TX45	45	140	19,50
FG 150XL/TX50	50	140	19,50
FG 150XL/TX55	55	140	19,50
FG 150XL/TX60	60	140	26,00
FG 150XL/TX70	70	140	29,00

CHIAVE A BUSSOLA DA 1/2" CON INSERTO EXTRA LUNGO PER VITI AD IMPRONTA TORX

Bussola in acciaio al cromo vanadio e finitura cromata lucida
 Inserto fosfatato con finitura brunita



CODICE	TX	L/mm	€/PZ
FG 150XXL/TX40	40	200	26,50
FG 150XXL/TX45	45	200	26,50
FG 150XXL/TX50	50	200	26,50
FG 150XXL/TX55	55	200	26,50
FG 150XXL/TX60	60	200	34,00
FG 150XXL/TX70	70	200	38,00

SET



SET 11 CHIAVI A BUSSOLA DA 1/2" CON INSERTI PER VITI AD IMPRONTA TORX

Fornito su supporto in ABS appendibile con ganci a clip e meccanismo finecorsa anticaduta

CODICE	Pz	Contenuto	€/PZ
FG 150TX/S11	11	TX10, TX15, TX20, TX25, TX27, TX30, TX40, TX45, TX50, TX55, TX60	165,00



SET 6 CHIAVI A BUSSOLA DA 1/2" CON INSERTI LUNGI PER VITI AD IMPRONTA TORX

Fornito su supporto in ABS appendibile con ganci a clip e meccanismo finecorsa anticaduta

CODICE	Pz	Contenuto	€/PZ
FG 150LTX/S6	6	TX30, TX40, TX45, TX50, TX55, TX60	105,50

SET 32 INSERTI A BUSSOLA CON IMPRONTA TORX - ATTACCO 1/2"

Fornito in box di ABS con clip di chiusura in acciaio



CODICE	Pz	€/PZ
FG 150TX/S32	32	195,00

CONTENUTO

	FG 150/TX	20 - 70
	FG 150L/TX	20 - 70
	FG 150XL/TX	40 - 70
	FG 150XXL/TX	40 - 70



SET 23 UTENSILI - ATTACCO 1/2"

Fornito in box di ABS



CODICE	Pz	€/PZ
FG 625TX/S23	23	232,00

CONTENUTO

	FG 624/TX	4, 5, 6, 7, 8, 10
	FG 625/TX	12, 14, 16, 18, 20, 22, 24
	FG 150/TX	10, 15, 20, 25, 27, 30, 40
	FG 625/CR12	
	FG 625/PA125	

SET 13 CHIAVI A BUSSOLA SNODATE TORX - ATTACCO 1/2"

Fornito in box di lamiera d'acciaio



CODICE	Pz	Contenuto	€/PZ
FG 625TX/S13	13	1/4": E4,E5,E6,E7,E8 3/8": E10,E12,E14,E16 1/2": E18,E20,E22,E24	160,00

SET CHIAVI E INSERTI A BUSSOLA CON IMPRONTA TORX - ATTACCO 1/2"

Fornito in box di ABS



CODICE	Pz	€/PZ
FG 625TX/S9B	9	77,50

CONTENUTO

	FG 625/TX	10, 12, 14, 16, 18
	FG 150/TX	25, 27, 30, 40

CHIAVE A BUSSOLA DA 1/2" CON INSERTO PER VITI AD IMPRONTA XZN

Bussola in acciaio al cromo vanadio e finitura cromata lucida
Inserto fosfatato con finitura brunita



CODICE	M	L/mm	€/PZ
FG 150/M5	5	55	13,50
FG 150/M6	6	55	13,50
FG 150/M8	8	55	13,50
FG 150/M9	9	55	13,50
FG 150/M10	10	55	13,50
FG 150/M12	12	55	13,50
FG 150/M14	14	55	13,50
FG 150/M16	16	55	14,50

CHIAVE A BUSSOLA DA 1/2" CON INSERTO LUNGO PER VITI AD IMPRONTA XZN

Bussola in acciaio al cromo vanadio e finitura cromata lucida
 Inserto fosfatato con finitura brunita



CODICE	M	L/mm	€/PZ
FG 150L/M5	5	100	16,00
FG 150L/M6	6	100	16,00
FG 150L/M8	8	100	16,00
FG 150L/M9	9	100	16,00
FG 150L/M10	10	100	16,00
FG 150L/M12	12	100	16,00
FG 150L/M14	14	100	16,00

CHIAVE A BUSSOLA DA 1/2" CON INSERTO EXTRA LUNGO PER VITI AD IMPRONTA XZN

Bussola in acciaio al cromo vanadio e finitura cromata lucida
 Inserto fosfatato con finitura brunita



CODICE	M	L/mm	€/PZ
FG 150XL/M5	5	140	19,50
FG 150XL/M6	6	140	19,50
FG 150XL/M8	8	140	19,50
FG 150XL/M9	9	140	19,50
FG 150XL/M10	10	140	19,50
FG 150XL/M12	12	140	26,50
FG 150XL/M14	14	140	29,00

CHIAVE A BUSSOLA DA 1/2" CON INSERTO EXTRA LUNGO PER VITI AD IMPRONTA XZN

Bussola in acciaio al cromo vanadio e finitura cromata lucida
 Inserto fosfatato con finitura brunita



CODICE	M	L/mm	€/PZ
FG 150XXL/M8	8	200	26,50
FG 150XXL/M10	10	200	26,50
FG 150XXL/M12	12	200	34,00
FG 150XXL/M14	14	200	38,50

SET



SET 7 CHIAVI A BUSSOLA DA 1/2" CON INSERTO PER VITI AD IMPRONTA XZN

Fornito su supporto in ABS appendibile con ganci a clip e meccanismo finecorsa anticaduta

CODICE	Pz	Contenuto	€/PZ
FG 150M/S7	7	M5, M6, M8, M10, M12, M14, M16	98,00



SET 7 CHIAVI A BUSSOLA DA 1/2" CON INSERTO LUNGO PER VITI AD IMPRONTA XZN

Fornito su supporto in ABS appendibile con ganci a clip e meccanismo finecorsa anticaduta

CODICE	Pz	Contenuto	€/PZ
FG 150LM/S7	7	LM5, LM6, LM8, LM9, LM10, LM12, LM14	115,50

SET 26 INSERTI A BUSSOLA CON IMPRONTA XZN - ATTACCO 1/2"

Fornito in box di ABS con clip di chiusura in acciaio



CODICE	Pz	€/PZ
FG 150M/S26	26	180,00

CONTENUTO

	FG 150/M	5 - 16
	FG 150L/M	5 - 16
	FG 150XL/M	5 - 14
	FG 150XXL/M	8 - 14



CHIAVE A BUSSOLA DA 1/2" CON INSERTO PER VITI AD IMPRONTA RIBE

Bussola in acciaio al cromo vanadio e finitura cromata lucida
Inserto fosfatato con finitura brunita



CODICE	R	L/mm	€/PZ
FG 150/R4	4	55	13,50
FG 150/R5	5	55	13,50
FG 150/R6	6	55	13,50
FG 150/R7	7	55	13,50
FG 150/R8	8	55	13,50
FG 150/R9	9	55	13,50
FG 150/R10	10	55	13,50
FG 150/R11	11	55	13,50
FG 150/R12	12	55	13,50
FG 150/R13	13	55	14,00
FG 150/R14	14	55	14,00

SET



SET 11 CHIAVI A BUSSOLA DA 1/2" CON INSERTI PER VITI AD IMPRONTA RIBE

Fornito su supporto in ABS appendibile con ganci a clip e meccanismo finecorsa anticaduta

CODICE	Pz	Contenuto	€/PZ
FG 150R/S11	11	R4, R5, R6, R7, R8, R9, R10, R11, R12, R12, R13, R14	144,50



CHIAVE A BUSSOLA DA 1/2" CON INSERTO LUNGO PER VITI AD IMPRONTA RIBE

Bussola in acciaio al cromo vanadio e finitura cromata lucida
Inserto fosfatato con finitura brunita



CODICE	R	L/mm	€/PZ
FG 150L/R4	4	100	15,00
FG 150L/R5	5	100	15,00
FG 150L/R6	6	100	15,00
FG 150L/R7	7	100	15,00
FG 150L/R8	8	100	15,00
FG 150L/R9	9	100	15,00
FG 150L/R10	10	100	15,00
FG 150L/R11	11	100	15,00
FG 150L/R12	12	100	15,00
FG 150L/R13	13	100	15,00
FG 150L/R14	14	100	15,00

CHIAVE A BUSSOLA DA 1/2" CON INSERTO PER VITI AD IMPRONTA RIBE FORATA

Bussola in acciaio al cromo vanadio e finitura cromata lucida
Inserto fosfatato con finitura brunita



CODICE	R	L/mm	€/PZ
FG 150/RF4	4	55	15,00
FG 150/RF5	5	55	15,00
FG 150/RF6	6	55	15,00
FG 150/RF7	7	55	15,00
FG 150/RF8	8	55	15,50
FG 150/RF9	9	55	15,50
FG 150/RF10	10	55	15,50
FG 150/RF11	11	55	15,50
FG 150/RF12	12	55	15,50
FG 150/RF13	13	55	16,00
FG 150/RF14	14	55	16,00

SET



SET 11 CHIAVI A BUSSOLA DA 1/2" CON INSERTI PER VITI AD IMPRONTA RIBE FORATA

Fornito su supporto in ABS appendibile con ganci a clip e meccanismo finecorsa anticaduta

CODICE	Pz	Contenuto	€/PZ
FG 150RF/S11	11	RF4 - RF14	173,50

CHIAVE A BUSSOLA DA 1/2" CON INSERTO LUNGO PER VITI AD IMPRONTA RIBE FORATA

Bussola in acciaio al cromo vanadio e finitura cromata lucida
Inserto fosfatato con finitura brunita



CODICE	R	L/mm	€/PZ
FG 150L/RF4	4	100	15,50
FG 150L/RF5	5	100	15,50
FG 150L/RF6	6	100	15,50
FG 150L/RF7	7	100	15,50
FG 150L/RF8	8	100	16,00
FG 150L/RF9	9	100	16,00
FG 150L/RF10	10	100	16,00
FG 150L/RF11	11	100	16,50
FG 150L/RF12	12	100	16,50
FG 150L/RF13	13	100	16,50
FG 150L/RF14	14	100	17,00



CHIAVE A BUSSOLA DA 1/2" CON INSERTO PER VITI AD IMPRONTA ESAGONALE

Bussola in acciaio al cromo vanadio e finitura cromata lucida
Inserto fosfatato con finitura brunita



CODICE	mm	L/mm	€/PZ
FG 150/H2	2	55	12,50
FG 150/H2,5	2.5	55	12,50
FG 150/H3	3	55	12,85
FG 150/H4	4	55	12,50
FG 150/H5	5	55	12,50
FG 150/H6	6	55	12,50
FG 150/H8	8	55	12,50
FG 150/H10	10	55	12,50
FG 150/H12	12	55	15,00
FG 150/H14	14	55	15,00
FG 150/H17	17	55	16,50
FG 150/H19	19	55	18,50

CHIAVE A BUSSOLA DA 1/2" CON INSERTO LUNGO PER VITI AD IMPRONTA ESAGONALE

Bussola in acciaio al cromo vanadio e finitura cromata lucida
Inserto fosfatato con finitura brunita



CODICE	mm	L/mm	€/PZ
FG 150L/H2	2	100	13,00
FG 150L/H2,5	2.5	100	13,00
FG 150L/H3	3	100	13,00
FG 150L/H4	4	100	13,00
FG 150L/H5	5	100	13,00
FG 150L/H6	6	100	13,00
FG 150L/H8	8	100	13,00
FG 150L/H10	10	100	13,00
FG 150L/H11	11	100	15,50
FG 150L/H12	12	100	17,00
FG 150L/H13	13	100	17,00



CHIAVE A BUSSOLA DA 1/2" CON INSERTO EXTRA LUNGO PER VITI AD IMPRONTA ESAGONALE

Bussola in acciaio al cromo vanadio e finitura cromata lucida
 Inserto fosfatato con finitura brunita



CODICE	mm	L/mm	€/PZ
FG 150XL/H5	5	140	17,00
FG 150XL/H6	6	140	17,00
FG 150XL/H7	7	140	17,00
FG 150XL/H8	8	140	17,00
FG 150XL/H10	10	140	17,00
FG 150XL/H12	12	140	18,00
FG 150XL/H14	14	140	18,00

CHIAVE A BUSSOLA DA 1/2" CON INSERTO EXTRA LUNGO PER VITI AD IMPRONTA ESAGONALE

Bussola in acciaio al cromo vanadio e finitura cromata lucida
 Inserto fosfatato con finitura brunita



CODICE	mm	L/mm	€/PZ
FG 150XXL/H5	5	200	26,00
FG 150XXL/H6	6	200	26,00
FG 150XXL/H7	7	200	26,00
FG 150XXL/H8	8	200	26,00
FG 150XXL/H10	10	200	27,00
FG 150XXL/H12	12	200	31,00

SET



SET 12 CHIAVI A BUSSOLA DA 1/2" CON INSERTO PER VITI AD IMPRONTA ESAGONALE

Fornito su supporto in ABS appendibile con ganci a clip e meccanismo finecorsa anticaduta

CODICE	Pz	Contenuto	€/PZ
FG 150H/S12	12	2,2,5,3,4,5,6,8,10,12,14,17,19mm	139,50



SET 9 CHIAVI A BUSSOLA DA 1/2" CON INSERTO PER VITI AD IMPRONTA ESAGONALE

Fornito su supporto in ABS appendibile con ganci a clip e meccanismo finecorsa anticaduta

CODICE	Pz	Contenuto	€/PZ
FG 150H/S9	9	4,5,6,8,10,5L,6L,8L,10Lmm	118,50

SET 30 INSERTI A BUSSOLA CON IMPRONTA ESAGONALE - ATTACCO 1/2"

Fornito in box di ABS con clip di chiusura in acciaio



CODICE	Pz	€/PZ
FG 150H/S30	30	200,00

CONTENUTO

	FG 150/H	5 - 19
	FG 150L/H	5 - 13
	FG 150XL/H	5 - 14
	FG 150XXL/H	5 - 12

CHIAVE A BUSSOLA DA 1/2" CON INSERTO LUNGO AD ESTREMITÀ SFERICA PER VITI CON IMPRONTA ESAGONALE

Bussola in acciaio al cromo vanadio e finitura cromata lucida
Inserto fosfatato con finitura brunita



CODICE	mm	L/mm	€/PZ
FG 150L/H5B	5	100	14,50
FG 150L/H6B	6	100	14,50
FG 150L/H7B	7	100	14,50
FG 150L/H8B	8	100	14,50
FG 150L/H10B	10	100	14,50

CHIAVE A BUSSOLA DA 1/2" CON INSERTO EXTRA LUNGO AD ESTREMITÀ SFERICA PER VITI CON IMPRONTA ESAGONALE

Bussola in acciaio al cromo vanadio e finitura cromata lucida
Inserto fosfatato con finitura brunita



CODICE	mm	L/mm	€/PZ
FG 150XXL/H5B	5	200	20,50
FG 150XXL/H6B	6	200	20,50
FG 150XXL/H7B	7	200	20,50
FG 150XXL/H8B	8	200	20,50
FG 150XXL/H10B	10	200	20,50

INSERTO A BUSSOLA RINFORZATO XZN - ATTACCO 1/2"

Acciaio al cromo molibdeno rinforzato
Finitura brunita



CODICE	mm	L/mm	€/PZ
FG 152/RM5	5	60	12,50
FG 152/RM6	6	60	12,50
FG 152/RM8	8	60	12,50
FG 152/RM9	9	60	12,50
FG 152/RM10	10	78	12,50
FG 152/RM12	12	78	14,00
FG 152/RM14	14	78	14,00
FG 152/RM16	16	78	14,00
FG 152/RM18	18	78	14,00

SET



SET 9 INSERTI A BUSSOLA RINFORZATI XZN - ATTACCO 1/2"

Fornito su supporto in ABS appendibile con ganci a clip e meccanismo finecorsa anticaduta

CODICE	Pz	Contenuto	€/PZ
FG 152RM/S9	9	RM5, RM6, RM8, RM9, RM10, RM12, RM14, RM16, RM18	125,00

INSERTO A BUSSOLA RINFORZATO ESAGONALE - ATTACCO 1/2"

Acciaio al cromo molibdeno rinforzato
Finitura brunita



CODICE	mm	L/mm	€/PZ
FG 152/RH5	5	60	12,50
FG 152/RH6	6	60	12,50
FG 152/RH7	7	60	12,50
FG 152/RH8	8	60	12,50
FG 152/RH10	10	68	12,50
FG 152/RH12	12	68	12,50
FG 152/RH14	14	78	14,50
FG 152/RH17	17	78	14,50
FG 152/RH19	19	78	14,50

SET 10 CHIAVI A BUSSOLA DA 1/2" CON INSERTI AD ESTREMITÀ SFERICA PER VITI CON IMPRONTA ESAGONALE

Fornito su supporto in ABS appendibile con ganci a clip e meccanismo finecorsa anticaduta

CODICE	Pz	Contenuto	€/PZ
FG 150H/S10B	10	5L,6L,7L,8L,10L,5XXL,6XXL,7XXL,8XXL,10XXL	170,00



SET



SET 9 INSERTI A BUSSOLA RINFORZATI ESAGONALI - ATTACCO 1/2"

Fornito su supporto in ABS appendibile con ganci a clip e meccanismo finecorsa anticaduta

CODICE	Pz	Contenuto	€/PZ
FG 152RH/S9	9	RH5, RH6, RH7, RH8, RH10, RH12, RH14, RH17, RH19	125,00

INSERTO A BUSSOLA RINFORZATO TORX - ATTACCO 1/2"

Acciaio al cromo molibdeno rinforzato
Finitura brunita



CODICE	mm	L/mm	€/PZ
FG 152/RTX20	20	60	15,00
FG 152/RTX25	25	60	15,00
FG 152/RTX27	27	60	15,00
FG 152/RTX30	30	60	15,00
FG 152/RTX40	40	60	15,00
FG 152/RTX45	45	68	16,00
FG 152/RTX50	50	68	17,00
FG 152/RTX55	55	68	17,00
FG 152/RTX60	60	68	17,00
FG 152/RTX70	70	78	17,00

SET



SET 10 INSERTI A BUSSOLA RINFORZATI TORX - ATTACCO 1/2"

Fornito su supporto in ABS appendibile con ganci a clip e meccanismo finecorsa anticaduta

CODICE	Pz	Contenuto	€/PZ
FG 152/RTXS10	10	RTX20, RTX25, RTX27, RTX30, RTX40, RTX45, RTX50, RTX55, RTX60, RTX70	165,00

CRICCHETTO REVERSIBILE CON ATTACCO QUADRO MASCHIO 1/2" A 72 DENTI

Sistema di inversione a ghiera integrato sulla testa
Meccanismo a 72 denti
Finitura cromata lucida
Appendibile tramite apposito gancio



CODICE	L/mm	■	€/PZ
FG 625/CR12	250	1/2"	54,00

CRICCHETTO REVERSIBILE CON ATTACCO QUADRO MASCHIO 1/2" A 60 DENTI ED IMPUGNATURA ROTANTE

Meccanismo di rotazione dell'impugnatura che fa ruotare la bussola con il minimo sforzo anche negli spazi più ristretti
Sistema di inversione a ghiera integrato sulla testa
Meccanismo a 60 denti
Finitura cromata lucida
Quadro maschio scorrevole per serraggi destrorsi e sinistrosi



CODICE	L/mm	■	€/PZ
FG 625/RT12	260	1/2"	82,00

CRICCHETTO REVERSIBILE CON ATTACCO QUADRO MASCHIO 1/2" A 72 DENTI

Testa sigillata per la massima protezione dalla polvere
Inversione a leva integrata a filo testa
Corpo scavato di 13° per consentire l'utilizzo anche in spazi ristretti
Meccanismo a 72 denti
Finitura cromata lucida
Appendibile tramite apposito gancio



CODICE	■	€/PZ
FG 625/FR12	1/2"	57,00

QUADRO MASCHIO 1/2" SNODATO CON IMPUGNATURA

Impugnatura ergonomica con scanalature anti-scivolo
Acciaio al cromo vanadio
Finitura lucida



CODICE	L/mm	€/PZ
FG 625/CS12	246	43,50

QUADRO MASCHIO SNODATO 1/2"

Acciaio al cromo vanadio
Finitura cromata lucida



CODICE	L/mm	€/PZ
FG 625/Q12	500	51,50

QUADRO MASCHIO SCORREVOLE 1/2"

Acciaio al cromo vanadio
Finitura cromata lucida



CODICE	L/mm	€/PZ
FG 625/ES12	305	16,50

SNODO CON ATTACCO QUADRO MASCHIO E FEMMINA 1/2"

Acciaio al cromo vanadio
Finitura cromata lucida



CODICE	L/mm	€/PZ
FG 625/SN12	76	23,00

PROLUNGA CON ATTACCO QUADRO MASCHIO E FEMMINA 1/2" ANGOLARE

Quadro maschio angolare che permette l'inclinazione fino a 8° rispetto all'asse della bussola
Acciaio al cromo vanadio
Finitura lucida



CODICE	L/mm	€/PZ
FG 625/PA50	50	11,50
FG 625/PA75	75	13,50
FG 625/PA125	125	16,00
FG 625/PA250	250	21,00

PROLUNGA CON ATTACCO QUADRO MASCHIO E FEMMINA 1/2"

Acciaio al cromo vanadio
Finitura lucida



CODICE	L/mm	€/PZ
FG 625/PR50	50	10,50
FG 625/PR75	75	12,00
FG 625/PR125	125	13,50
FG 625/PR250	250	16,00



SET 108 UTENSILI - ATTACCO 1/4" E 1/2"

Fornito in box di ABS



CODICE	Pz	€/PZ
FG BEST 108	108	270,00

CONTENUTO

	FG 625/A	10,11,12,13,14,15,16,17,18,19,20,21,22,23,24,27,30,32
	FG 624/E	4,4.5,5,5.5,6,7,8,9,10,11,12,13,14
	FG 625L/A	14,15,17,19,22
	FG 624E/L	6,7,8,9,10,11,12,13
	FG 625/TX	10,11,12,14,16,18,20,24
	FG 624/TX	4,5,6,7,8
	FG 181/B	16,21
	FG 624/CR14 FG 625/CR12	
	FG 625/SN12 FG 624/SN14	
	FG 625/ES12 FG 624/ES14	
	FG 624/GR14	
	FG 625/PR FG 624/PR	125 50,100
	FG 87/AD	
	FG 139/D	1.5,2,2.5
	FG 147/	PH (1,2), PZ (1,2), SL (4, 5.5, 6.5), H (4,5.5,6.5), TX (10,15,20,25,30)
	FG 85/	PH (3,4), PZ (3,4), SL (8,10,12), H (7,8,10,12,14), TX (40,45,50,55,60)

SET 171 UTENSILI - ATTACCO 1/4", 3/8" E 1/2"

Fornito in box di ABS



CODICE	Pz	€/PZ
FG BEST 171	171	400,00

CONTENUTO

	FG 625/A	10,11,12,13,14,15,16,17,18,19,20,21,22,23,24,27,30,32
	FG 624/B	10,11,12,13,14,15,16,17,18,19
	FG 624/E	4,4.5,5,5.5,6,7,8,9,10,11,12,13,14
	FG 625L/A	16,17,18,19,22
	FG 624B/L	10,11,12,13,14,15
	FG 624E/L	4,5,6,7,8,9,10
	FG 625/TX	20,24
	FG 624B/TX	10,11,12,14,16,18 4,5,6,7,8
	FG 624/TX	16,21
	FG 181/B	
	FG 624/CR14 FG 624/CR38 FG 625/CR12	
	FG 624/SN14 FG 624/SN38 FG 625/SN12	
	FG 625/ES12 FG 624/ES14	
	FG 624/GR14	
	FG 625/PR125 FG 624B/PR125 FG 624/PR50,100	125 125 50,100
	FG 87/AD	
	FG 139/D	1,1.5,2,2.5,3,4,4.5,5
	FG 147/	PH (0,1,2), PZ (0,1,2), SL (4,5,5.5,6,5.7), H (3,4,5), TX (8-30), RTX (8-30)
	FG 85/	PH (3,4), PZ (3,4), SL (8,10,12), H (7,8,10,12,14), TX (40-50), TT (10-45), M (5-9)



SET 27 UTENSILI - ATTACCO 1/2"

Fornito in box di ABS con clip di chiusura in acciaio



1/2"

CODICE	Pz	€/PZ
FG 625/S27	27	190,00

CONTENUTO

	FG 625/A	8,9,10,11,12,13,14,15,16,17,18,19,20,21,22,23,24,25,26,27,30,32
	FG 625/CR12	
	FG 625/SN12	
	FG 625/ES12	
	FG 625/PA	125,250



SET 110 UTENSILI - ATTACCO 1/4" E 1/2"

Fornito in box di ABS con clip di chiusura in acciaio



1/4"

1/2"

CODICE	Pz	€/PZ
FG 625/S110	110	470,00

CONTENUTO

	FG 625/A	8,9,10,11,12,13,14,15,16,17,18,19,20,21,22,23,24,25,26,27,30,32
	FG 624/E	4,5,6,7,8,9,10,11,12,13,14
	FG 624/CR14 FG 625/CR12	
	FG 625/SN12 FG 624/SN14	
	FG 625/ES12 FG 624/ES14	
	FG 624/GR14C	
	FG 625/PA FG 624/PA	125, 250 50, 100
	FG 89/38P11	1/4"x1/4"
	FG 85/25PH FG 85/25SL FG 85/25PZ FG 85/H FG 85/25T FG 88/60P12	1,2,3 3,4,4,5,5,5,6,6,5 1,2,3 1,5,2,2,5,3,4,5,6 9,10,15,20,25,27,30,40
	FG 139/B	
	FG 48/L	
	FG 49	
	FG 600/B	8,10,11,12,13,14,15,17,19
	FG 22 FG 22/PH	3x75, 4x100, 5.5x100 0x60, PH1x80, PH2x100
	FG 59XT/160 FG 63XT/160	
	FG 58/B240	
	FG 132/H500	
	FG 79/SP	
	FG 93/M24	
	FG 44/MT5	



SET 74 UTENSILI - ATTACCO 1/4" ED 1/2"

Fornito in box di ABS con clip di chiusura in acciaio



CODICE	Pz	€/PZ
FG 625/S74	74	250,00

CONTENUTO

	FG 625/A	8,9,10,11,12,13,14,15,16,17,18,19,20,21,22,23,24,25,26,27,30,32mm
	FG 624/E	4,5,6,7,8,9,10,11,12,13,14mm
	FG 624/CR14	1/4"
	FG 625/CR12	1/2"
	FG 624/SN14	1/4"
	FG 625/SN12	1/2"
	FG 624/ES14	1/4"
	FG 625/ES12	1/2"
	FG 624/GR14C	
	FG 625/PA125	1/2" - 125mm
	FG 624/PA50, 100	1/4" - 50, 100mm
	FG 89/38P11	1/4" x 1/4"
	FG 85/25PH	1, 2, 3
	FG 85/25SL	3, 4, 4.5, 5, 5.5, 6, 6.5
	FG 85/25PZ	1, 2, 3
	FG 85/H	1.5, 2, 2.5, 3, 4, 5, 6
	FG 85/25T	9, 10, 15, 20, 25, 27, 30, 40

SET 94 UTENSILI - ATTACCO 1/4" ED 1/2"

Fornito in box di ABS con clip di chiusura in acciaio



CODICE	Pz	€/PZ
FG 625/S94	94	300,00

CONTENUTO

	FG 625/A	8,9,10,11,12,13,14,15,16,17,18,19,20,21,22,23,24,25,26,27,30,32mm
	FG 624/E	4,5,6,7,8,9,10,11,12,13,14mm
	FG 625L/A	10, 13, 14, 15, 17, 19 mm
	FG 624E/L	4, 5, 6, 7, 8, 9, 10, 11, 12, 13, 14 mm
	FG 624/CR14	1/4"
	FG 625/CR12	1/2"
	FG 624/SN14	1/4"
	FG 625/SN12	1/2"
	FG 624/ES14	1/4"
	FG 625/ES12	1/2"
	FG 624/GR14C	
	FG 625/PA125, 250	1/2" - 125, 250 mm
	FG 624/PA50, 100	1/4" - 50, 100mm
	FG 89/38P11	1/4" x 1/4"
	FG 85/25PH	1, 2, 3
	FG 85/25SL	3, 4, 4.5, 5, 5.5, 6, 6.5
	FG 85/25PZ	1, 2, 3
	FG 85/H	1.5, 2, 2.5, 3, 4, 5, 6
	FG 85/25T	9, 10, 15, 20, 25, 27, 30, 40
	FG 88/60P12	



FASANO[®]
TOOLS

CHIAVE A BUSSOLA ESAGONALE - ATTACCO 3/4"

Acciaio al cromo vanadio
Finitura cromata lucida
Utilizzabile con bulloni esagonali

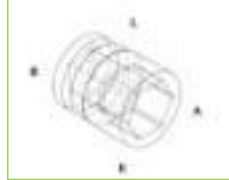

CODICE	mm	A/mm	B/mm	E/mm	L/mm	€/PZ
FG 629/A19	19	33.0	29.2	14.0	50.0	14,00
FG 629/A22	22	36.0	32.2	14.0	50.0	14,50
FG 629/A24	24	36.0	33.2	14.0	50.0	16,00
FG 629/A26	26	36.0	37.0	22.0	52.0	16,50
FG 629/A27	27	36.0	38.0	22.0	52.0	16,50
FG 629/A28	28	36.0	39.0	22.0	52.0	17,00
FG 629/A29	29	38.0	40.0	22.0	52.0	17,00
FG 629/A30	30	38.0	42.0	24.0	54.0	19,00
FG 629/A32	32	38.0	44.0	26.0	56.0	19,00
FG 629/A33	33	38.0	46.0	26.0	56.0	20,00
FG 629/A34	34	38.0	47.0	26.0	56.0	20,00
FG 629/A35	35	42.0	48.0	26.0	58.0	21,50
FG 629/A36	36	42.0	50.0	28.0	58.0	22,50
FG 629/A38	38	45.0	52.0	28.0	60.0	23,00
FG 629/A41	41	45.0	56.0	30.0	64.0	26,00
FG 629/A46	46	48.0	62.0	34.0	68.0	34,00
FG 629/A50	50	48.0	68.0	36.0	72.0	39,50
FG 629/A55	55	48.0	74.0	40.0	76.0	48,50
FG 629/A60	60	48.0	80.0	42.0	78.0	57,00

CHIAVE A BUSSOLA POLIGONALE - ATTACCO 3/4"

Acciaio al cromo vanadio
Finitura cromata lucida
Utilizzabile con bulloni esagonali e poligonal



CODICE	mm	A/mm	B/mm	E/mm	L/mm	€/PZ
FG 629/B19	19	33.0	29.2	14.0	50.0	14,00
FG 629/B22	22	36.0	32.2	14.0	50.0	14,50
FG 629/B23	23	36.0	33.2	14.0	50.0	14,50
FG 629/B24	24	36.0	33.2	14.0	50.0	16,00
FG 629/B26	26	36.0	37.0	22.0	52.0	16,50
FG 629/B27	27	36.0	38.0	22.0	52.0	16,50
FG 629/B28	28	36.0	39.0	22.0	52.0	17,00
FG 629/B29	29	38.0	40.0	22.0	52.0	17,00

CODICE	mm	A/mm	B/mm	E/mm	L/mm	€/PZ
FG 629/B30	30	38.0	42.0	24.0	54.0	19,00
FG 629/B32	32	38.0	44.0	26.0	56.0	19,00
FG 629/B33	33	38.0	46.0	26.0	56.0	20,00
FG 629/B34	34	38.0	47.0	26.0	56.0	20,00
FG 629/B35	35	42.0	48.0	26.0	58.0	21,50
FG 629/B36	36	42.0	50.0	28.0	58.0	22,50
FG 629/B38	38	45.0	52.0	28.0	60.0	23,00
FG 629/B41	41	45.0	56.0	30.0	64.0	26,00
FG 629/B46	46	48.0	62.0	34.0	68.0	34,00
FG 629/B50	50	48.0	68.0	36.0	72.0	39,50
FG 629/B55	55	48.0	74.0	40.0	76.0	48,50
FG 629/B60	60	48.0	80.0	42.0	78.0	57,00

SET 10 CHIAVI A BUSSOLA ESAGONALI - ATTACCO 3/4"

Fornito in box di ABS



CODICE	Pz	€/PZ
FG 629/S10	10	494,50

CONTENUTO

	FG 629/A	34,36,41,46,50mm
	FG 629/CR34	
	FG 629/SN34	
	FG 629/ES34	
	FG 629/PR200	



SET 10 CHIAVI A BUSSOLA POLIGONALI - ATTACCO 3/4"

Fornito in box di ABS



CODICE	Pz	€/PZ
FG 629B/S10	10	494,50

CONTENUTO

	FG 629/B	34,36,41,46,50mm
	FG 629/CR34	
	FG 629/SN34	
	FG 629/ES34	
	FG 629/PR200	





SET 15 CHIAVI A BUSSOLA ESAGONALI - ATTACCO 3/4"

Fornito in box di lamiera d'acciaio



CODICE	Pz	€/PZ
FG 629A/S15	15	600,00

CONTENUTO

	FG 629/A	19,22,24,27,30,32,36,41,46,50,60mm
	FG 629/CR34	
	FG 629/SN34	
	FG 629/ES34	
	FG 629/PR200	





SET 15 CHIAVI A BUSSOLA POLIGONALI - ATTACCO 3/4"

Fornito in box di lamiera d'acciaio

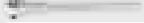

CODICE	Pz	€/PZ
FG 629B/S15	15	618,00

CONTENUTO

	FG 629/B	19,22,23,27,30,32,36,41,46,50,60mm
	FG 629/CR34	
	FG 629/SN34	
	FG 629/ES34	
	FG 629/PR200	

CRICCHETTO REVERSIBILE CON ATTACCO QUADRO MASCHIO 3/4" A 40 DENTI

Sistema di aggancio/sgancio rapido

Acciaio al cromo vanadio

Finitura lucida

Codice cricco di ricambio FG 629/CR34R



3/4"

CODICE	■	L/mm	€/PZ
FG 629/CR34	3/4"	500	135,00

PROLUNGA CON ATTACCO QUADRO MASCHIO E FEMMINA 3/4"

Acciaio al cromo vanadio

Finitura lucida



3/4"

CODICE	L/mm	€/PZ
FG 629/PR200	200	29,00
FG 629/PR400	400	43,50

PROLUNGA AD L CON ATTACCO QUADRO MASCHIO E FEMMINA 3/4"

Acciaio al cromo vanadio
Finitura lucida



3/4"

CODICE	L/mm	€/PZ
FG 629/PRL	455	43,50

QUADRO MASCHIO SCORREVOLE 3/4"

Acciaio al cromo vanadio
Finitura lucida



3/4"

CODICE	L/mm	€/PZ
FG 629/ES34	405	43,50

QUADRO MASCHIO SNODATO 3/4"

Acciaio al cromo vanadio
Finitura lucida



3/4"

CODICE	L/mm	€/PZ
FG 629/QS34	500	67,00

SNODO CON ATTACCO QUADRO MASCHIO E FEMMINA 3/4"

Acciaio al cromo vanadio
Finitura lucida



3/4"

CODICE	L/mm	€/PZ
FG 629/SN34	105	67,00

CHIAVE A BUSSOLA POLIGONALE - ATTACCO 1"

Acciaio al cromo vanadio
Finitura cromata lucida
Utilizzabile con bulloni esagonali e poligonali

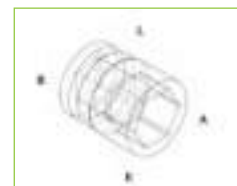

1"

CODICE	mm	A/mm	B/mm	E/mm	L/mm	€/PZ
FG 630/B36	36	52.0	55.0	21.0	62.0	36,50
FG 630/B41	41	52.0	61.5	26.0	62.0	36,50
FG 630/B46	46	58.0	68.0	27.0	64.0	41,50
FG 630/B50	50	58.0	72.9	31.07	70.0	47,50
FG 630/B55	55	58.0	79.0	31.0	70.0	51,50
FG 630/B60	60	62.0	87.1	35.0	78.0	60,00
FG 630/B65	65	62.0	93.0	36.0	80.0	82,00
FG 630/B70	70	62.0	98.0	40.0	85.0	84,50
FG 630/B75	75	86.0	103.9	48.0	95.0	98,00
FG 630/B80	80	86.0	110.0	52.0	98.0	105,00

CRICCHETTO REVERSIBILE CON ATTACCO QUADRO MASCHIO 1" A 24 DENTI

Sistema di aggancio/sgancio rapido
Acciaio al cromo vanadio
Finitura lucida



1"

CODICE	L/mm	€/PZ
FG 630/CR1	650	196,00



PROLUNGA CON ATTACCO QUADRO MASCHIO E FEMMINA 1"

Acciaio al cromo vanadio
Finitura lucida



1"

CODICE	L/mm	€/PZ
FG 630/PR200	200	51,50
FG 630/PR400	400	72,50

QUADRO MASCHIO SCORREVOLE 1"

Acciaio al cromo vanadio
Finitura lucida



1"

CODICE	L/mm	€/PZ
FG 630/ES1	550	93,00

SET 12 CHIAVI A BUSSOLA POLIGONALI - ATTACCO 1"

Fornito in box di lamiera d'acciaio



CODICE	Pz	€/PZ
FG 630B/S8	12	1.160,00

CONTENUTO

	FG 630/B	46,50,55,60,65,70,75,80mm
	FG 630/CR1	
	FG 630/ES1	
	FG 630/PR200	
	FG 630/PR400	

CHIAVE A BUSSOLA ESAGONALE RINFORZATA - ATTACCO 3/8"

Acciaio al cromo molibdeno rinforzato
Finitura brunita



3/8"

CODICE	mm	A/mm	B/mm	D/mm	E/mm	€/PZ
FG 627/C8	8	13.0	17.7	30.0	10.9	6,00
FG 627/C9	9	14.3	17.8	30.0	11.5	6,00
FG 627/C10	10	15.5	17.8	30.0	11.7	6,00
FG 627/C11	11	16.7	17.8	30.0	11.8	6,00
FG 627/C12	12	17.8	17.8	30.0	11.5	6,00
FG 627/C13	13	19.8	19.8	30.0	11.5	6,50
FG 627/C14	14	21.9	21.9	30.0	16.4	6,50
FG 627/C15	15	23.9	23.9	30.0	16.5	6,50
FG 627/C16	16	23.9	23.9	30.0	16.5	6,50
FG 627/C17	17	25.8	25.8	30.0	16.5	6,50
FG 627/C18	18	27.9	27.9	30.0	16.5	6,70
FG 627/C19	19	27.8	27.9	30.0	16.5	6,70
FG 627/C20	20	29.8	29.8	30.0	16.5	7,60
FG 627/C21	21	29.8	29.9	30.0	17.0	7,60
FG 627/C22	22	31.9	31.9	30.0	17.0	8,20

SET



SET 15 CHIAVI A BUSSOLA ESAGONALI RINFORZATE - ATTACCO 3/8"

Fornito in box di ABS

CODICE	Pz	Contenuto	€/PZ
FG 627/S15B	15	8,9,10,11,12,13,14,15,16,17,18,19,20,21,22mm	120,00

CHIAVE A BUSSOLA ESAGONALE RINFORZATA LUNGA - ATTACCO 1/2"

Acciaio al cromo molibdeno rinforzato
Finitura brunita



CODICE	mm	A/mm	B/mm	C/mm	L/mm	€/PZ
FG 628/L10	10	17.5	25	13	80	15,00
FG 628/L11	11	19.0	25	13	80	15,00
FG 628/L12	12	20.0	25	13	80	15,00
FG 628/L13	13	21.0	25	13	80	15,00
FG 628/L14	14	23.0	25	13	80	15,00
FG 628/L15	15	24.0	25	13	80	15,00
FG 628/L16	16	25.0	25	13	80	15,00
FG 628/L17	17	26.5	30	17	80	15,00
FG 628/L18	18	28.0	30	18	80	19,00
FG 628/L19	19	29.0	30	19	80	19,00
FG 628/L21	21	32.0	30	21	80	20,00
FG 628/L22	22	33.0	30	22	80	20,00
FG 628/L23	23	34.0	30	23	80	21,00
FG 628/L24	24	35.0	30	24	80	21,00
FG 628/L25	25	36.5	30	25	80	25,00
FG 628/L27	27	39.0	30	27	80	25,00
FG 628/L29	29	42.5	30	30	80	33,00
FG 628/L30	30	43.5	30	30	80	33,00
FG 628/L32	32	44.5	30	32	80	33,00

SET



SET 19 CHIAVI A BUSSOLA ESAGONALI RINFORZATE LUNGHE - ATTACCO 1/2"

Fornito in box di ABS

CODICE	Pz	Contenuto	€/PZ
FG 628/LS19	19	10,11,12,13,14,15,16,17,18,19,21,22,23,24,25,27,29,30,32mm	443,00

CHIAVE A BUSSOLA ESAGONALE RINFORZATA - ATTACCO 1/2"

Acciaio al cromo molibdeno rinforzato
Finitura brunita



CODICE	mm	A/mm	B/mm	D/mm	E/mm	€/PZ
FG 628/C10	10	15.6	22.6	38.1	7.1	8,50
FG 628/C11	11	17.8	22.6	38.1	8.4	8,50
FG 628/C12	12	18.2	24.3	38.1	9.7	8,50
FG 628/C13	13	19.3	24.3	38.1	9.7	8,50
FG 628/C14	14	22.0	24.3	38.1	10.7	8,50
FG 628/C15	15	23.2	26.6	38.1	10.7	9,50
FG 628/C16	16	24.3	26.6	38.1	11.9	9,50
FG 628/C17	17	25.4	26.6	38.1	12.7	9,50
FG 628/C18	18	26.6	26.6	38.1	12.7	9,50
FG 628/C19	19	28.3	28.3	38.1	12.7	9,50
FG 628/C20	20	29.9	29.9	38.1	14.2	9,50
FG 628/C21	21	31.5	31.5	38.1	14.2	10,50
FG 628/C22	22	33.1	33.3	38.1	14.2	10,50
FG 628/C23	23	34.0	34.0	44.5	16.3	11,00
FG 628/C24	24	34.8	34.8	44.5	16.3	11,00
FG 628/C25	25	36.4	36.4	44.5	19.6	12,00
FG 628/C26	26	37.8	37.8	50.8	19.8	13,50
FG 628/C27	27	39.4	39.4	50.8	20.3	13,50
FG 628/C30	30	43.5	41.5	51.5	21.4	14,50
FG 628/C32	32	44.5	41.5	51.5	21.8	17,00

SET



SET 10 CHIAVI A BUSSOLA ESAGONALI RINFORZATE - ATTACCO 1/2"

Fornito su supporto in ABS appendibile con ganci a clip e meccanismo finecorsa anticaduta

CODICE	Pz	Contenuto	€/PZ
FG 628/S10	10	10,11,12,13,15,16,17,18,19,21mm	108,50





SET 20 CHIAVI A BUSSOLA ESAGONALI RINFORZATE - ATTACCO 1/2"

Fornito in box di ABS

CODICE	Pz	Contenuto	€/PZ
FG 628/S20	20	10,11,12,13,14,15,16,17,18,19,20,21,22,23,24,25,26,27,30,32mm	278,50

CHIAVE A BUSSOLA TORX RINFORZATA - ATTACCO 1/2"

Acciaio al cromo molibdeno rinforzato
Finitura brunita



CODICE	E	A/mm	B/mm	D/mm	E/mm	€/PZ
FG 628/TX8	8	13.0	21.8	38.0	14.0	11,50
FG 628/TX10	10	14.0	21.8	38.0	14.0	11,50
FG 628/TX12	12	15.0	21.8	38.0	14.0	12,50
FG 628/TX14	14	17.0	21.8	38.0	14.0	12,50
FG 628/TX16	16	18.0	21.8	38.0	14.0	12,50
FG 628/TX18	18	20.0	21.8	38.0	14.0	12,50
FG 628/TX20	20	24.0	21.8	38.0	14.0	12,50
FG 628/TX22	22	25.8	24	38.0	14.0	13,50
FG 628/TX24	24	27.8	26	38.0	14.0	13,50

SET



SET CHIAVI A BUSSOLA TORX RINFORZATA - ATTACCO 1/2"

Fornito su supporto in plastica

CODICE	Pz	Contenuto	€/PZ
FG 628TX/S9	9	E8, E10,E12,E14,E16,E18,E20,E22,E24	120,00

CHIAVE A BUSSOLA ESAGONALE RINFORZATA PIATTA - ATTACCO 1/2"

Acciaio al cromo molibdeno rinforzato
Finitura brunita



CODICE	mm	A/mm	B/mm	D/mm	E/mm	€/PZ
FG 628/D10	10	17.0	23.8	28.0	7.0	8,50
FG 628/D11	11	18.0	23.9	28.0	5.5	8,50
FG 628/D12	12	19.0	23.9	28.0	7.0	8,50
FG 628/D13	13	19.8	24.0	28.0	8.0	8,50
FG 628/D14	14	22.0	24.0	28.0	6.5	8,50
FG 628/D15	15	24.0	24.0	28.0	7.5	9,50
FG 628/D16	16	24.0	24.0	28.0	7.0	9,50
FG 628/D17	17	26.0	26.0	28.0	8.0	9,50
FG 628/D18	18	28.0	28.0	28.0	7.0	9,50
FG 628/D19	19	28.0	28.0	28.0	8.5	9,50
FG 628/D20	20	30.0	30.0	28.0	8.5	9,50
FG 628/D21	21	30.0	30.0	28.0	8.0	10,50
FG 628/D22	22	32.0	28.0	28.0	9.0	10,50
FG 628/D23	23	33.0	28.0	28.0	9.0	11,20
FG 628/D24	24	34.0	30.0	28.0	9.0	11,20
FG 628/D27	27	38.0	30.0	28.0	10.0	13,50
FG 628/D30	30	42.0	34.0	28.0	10.0	14,50
FG 628/D32	32	44.0	36.0	28.0	9.0	17,00

SET



SET 12 CHIAVI A BUSSOLA ESAGONALI RINFORZATE PIATTE - ATTACCO 1/2"

Fornito su supporto in ABS appendibile con ganci a clip e meccanismo finecorsa anticaduta

CODICE	Pz	Contenuto	€/PZ
FG 628/S12	12	10,11,12,13,14,15,16,17,18,19,20,21mm	130,00



SET 6 CHIAVI A BUSSOLA ESAGONALI RINFORZATE PIATTE - ATTACCO 1/2"

Fornito su supporto in ABS appendibile con ganci a clip e meccanismo finecorsa anticaduta

CODICE	Pz	Contenuto	€/PZ
FG 628/S6	6	22,23,24,27,30,32mm	95,00

PROLUNGA RINFORZATA CON ATTACCO QUADRO MASCHIO E FEMMINA - ATTACCO 1/2"

Acciaio al cromo molibdeno rinforzato
Finitura brunita



CODICE	L/mm	€/PZ
FG 628/PR125	125	15,00
FG 628/PR250	250	16,00
FG 628/PR380	380	21,00

CHIAVE A BUSSOLA PER SERRAGGIO GHIERE KM

Acciaio al cromo molibdeno rinforzato
Finitura brunita
Utilizzabile con ghiera KM con denti esterni



CODICE	KM	D/mm	D1/mm	Num denti	Attacco	€/PZ
FG 631/KM4	4	32	28	4	1/2"	48,50
FG 631/KM5	5	38	34	4	1/2"	52,50
FG 631/KM6	6	45	40	4	1/2"	63,00
FG 631/KM7	7	52	48	4	1/2"	73,50
FG 631/KM8	8	58	52	4	1/2"	73,50
FG 631/KM9	9	65	59	4	3/4"	84,00
FG 631/KM10	10	70	65	4	3/4"	100,00
FG 631/KM11	11	75	67	4	3/4"	100,00
FG 631/KM12	12	80	73	4	3/4"	108,50

CHIAVE A BUSSOLA PER SERRAGGIO GHIERE KM

Acciaio al cromo molibdeno rinforzato
Finitura brunita
Utilizzabile con ghiera KM con denti interni

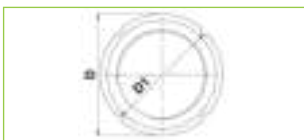

CODICE	KM	D/mm	D1/mm	Num denti	Attacco	€/PZ
FG 632/KM4	4	37.5	28	4	1/2"	47,50
FG 632/KM5	5	44.5	34	4	1/2"	50,50
FG 632/KM6	6	52.5	41	4	1/2"	60,00
FG 632/KM7	7	59.5	48	4	1/2"	68,50
FG 632/KM8	8	65.5	52	4	1/2"	73,50
FG 632/KM9	9	73.5	60	4	3/4"	84,00
FG 632/KM10	10	@\70.0	65	4	3/4"	94,50
FG 632/KM11	11	83.0	69	4	3/4"	94,50
FG 632/KM12	12	88.0	74	4	3/4"	100,00

SET



SET 9 CHIAVI A BUSSOLA PER GHIERE KM CON DENTI ESTERNI
Fornito in box di ABS

CODICE	Pz	Contenuto	€/PZ
FG 631/S9	9	KM4-KM12	766,50



SET 9 CHIAVI A BUSSOLA PER GHIERE KM CON DENTI INTERNI
Fornito in box di ABS

CODICE	Pz	Contenuto	€/PZ
FG 632/S9	9	KM4-KM12	808,50



CHIAVE A BUSSOLA ESAGONALE RINFORZATA - ATTACCO 3/4"

Acciaio al cromo molibdeno rinforzato
Finitura brunita
Utilizzabile con bulloni esagonali

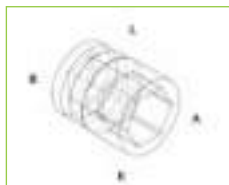

CODICE	mm	A/mm	B/mm	E/mm	L/mm	€/PZ
FG 629/C17	17	30.0	44.0	14.0	51.0	23,00
FG 629/C18	18	31.0	44.0	14.0	51.0	23,00
FG 629/C19	19	32.5	44.0	14.0	51.0	23,00
FG 629/C21	21	35.0	44.0	14.0	51.0	23,00
FG 629/C22	22	36.0	44.0	14.0	51.0	23,00
FG 629/C23	23	37.5	44.0	14.0	51.0	23,50
FG 629/C24	24	38.5	44.0	14.0	51.0	23,50
FG 629/C27	27	42.5	44.0	20.0	53.0	23,50
FG 629/C28	28	44.0	44.0	20.0	53.0	23,50
FG 629/C30	30	46.0	44.0	20.0	53.0	23,50
FG 629/C32	32	48.5	44.0	21.0	57.0	24,50
FG 629/C33	33	50.0	44.0	21.0	57.0	26,50
FG 629/C34	34	51.0	44.0	21.0	57.0	26,50
FG 629/C36	36	53.5	44.0	21.0	57.0	28,00
FG 629/C40	40	58.5	44.0	22.0	58.0	33,00
FG 629/C41	41	60.0	44.0	22.0	58.0	33,00
FG 629/C46	46	66.0	44.0	25.0	62.0	39,50
FG 629/C50	50	71.0	44.0	30.0	68.0	49,50
FG 629/C54	54	76.0	54.0	32.0	72.0	51,50
FG 629/C55	55	77.5	54.0	32.0	72.0	54,00
FG 629/C58	58	81.0	54.0	32.0	72.0	62,00
FG 629/C60	60	83.5	54.0	32.0	72.0	67,00

SET



SET 10 CHIAVI A BUSSOLA ESAGONALI RINFORZATE - ATTACCO 3/4"

Fornito in box di lamiera d'acciaio

CODICE	Pz	Contenuto	€/PZ
FG 629C/S10	10	17,19,22,24,27,30,32,36,41,46mm	299,00

CHIAVE A BUSSOLA ESAGONALE RINFORZATA LUNGA - ATTACCO 3/4"

Acciaio al cromo molibdeno rinforzato
Finitura brunita
Utilizzabile con bulloni esagonali



CODICE	mm	A/mm	B/mm	C/mm	L/mm	€/PZ
FG 629/L17	17	30.0	44.0	26.0	90.0	35,00
FG 629/L19	19	32.5	44.0	26.0	90.0	35,00
FG 629/L21	21	35.0	44.0	26.0	90.0	35,00
FG 629/L22	22	36.0	44.0	26.0	90.0	35,00
FG 629/L24	24	38.5	44.0	26.0	90.0	35,00
FG 629/L26	26	38.5	44.0	28.0	90.0	33,00
FG 629/L27	27	42.5	44.0	28.0	90.0	35,00
FG 629/L30	30	46.0	44.0	28.0	90.0	37,00
FG 629/L32	32	48.5	44.0	28.0	90.0	37,00
FG 629/L33	33	50.0	44.0	30.0	90.0	41,00
FG 629/L34	34	51.0	44.0	30.0	90.0	44,50
FG 629/L36	36	53.5	44.0	30.0	90.0	47,50
FG 629/L38	38	56.0	44.0	34.0	90.0	47,50
FG 629/L41	41	60.0	44.0	34.0	90.0	55,00
FG 629/L46	46	66.0	44.0	34.0	90.0	65,50
FG 629/L50	50	71.0	44.0	36.0	90.0	76,00

CHIAVE A BUSSOLA ESAGONALE RINFORZATA - ATTACCO 1"

Acciaio al cromo molibdeno rinforzato
Finitura brunita
Utilizzabile con bulloni esagonali

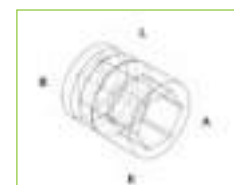

CODICE	mm	A/mm	B/mm	L/mm	E/mm	€/PZ
FG 630/A24	24	53.96	41.53	57.0	30.13	36,00
FG 630/A27	27	53.98	45.24	56.92	21.46	36,00
FG 630/A30	30	48.94	53.95	61.88	27.41	36,00
FG 630/A32	32	51.42	53.88	62.0	28.47	37,00
FG 630/A33	33	52.73	53.25	61.87	28.16	37,00
FG 630/A34	34	53.91	53.94	61.80	25.88	37,00
FG 630/A36	36	56.50	54.07	62.06	26.50	37,00
FG 630/A38	38	58.88	54.0	65.93	30.0	45,50
FG 630/A41	41	62.8	54.18	66.04	28.27	47,50
FG 630/A46	46	68.7	53.96	70.24	30.6	51,50
FG 630/A50	50	73.9	54.0	70.0	30.8	65,50
FG 630/A55	55	80.05	53.91	81.9	34.32	70,50
FG 630/A60	60	86.56	54.2	84.88	27.11	86,50
FG 630/A65	65	92.7	53.96	85.25	37.97	97,00
FG 630/A70	70	97.88	61.91	84.71	37.27	110,50
FG 630/A75	75	103.9	85.87	94.91	47.95	145,00
FG 630/A80	80	111.48	60.5	90.5	41.57	152,50

SET



SET 14 CHIAVI A BUSSOLA ESAGONALI RINFORZATE - ATTACCO 1"

Fornito in box di lamiera d'acciaio

CODICE	Pz	Contenuto	€/PZ
FG 630A/S14	14	24,27,30,32,33,34,36,38,41,46,50,55,60,65mm	830,00

CHIAVE A BUSSOLA ESAGONALE RINFORZATA LUNGA - ATTACCO 1"

Acciaio al cromo molibdeno rinforzato
Finitura brunita



CODICE	mm	A/mm	B/mm	C/mm	L/mm	€/PZ
FG 630/L24	24	51.0	51.0	17.0	108.0	61,00
FG 630/L27	27	51.0	51.0	17.0	108.0	63,00
FG 630/L30	30	51.0	51.0	21.0	108.0	63,00
FG 630/L32	32	51.0	51.0	21.0	108.0	64,50
FG 630/L33	33	52.0	52.0	21.0	108.0	66,50
FG 630/L34	34	52.0	52.0	21.0	108.0	71,50
FG 630/L36	36	52.0	52.0	21.0	108.0	71,50
FG 630/L41	41	52.0	61.5	26.0	108.0	78,00
FG 630/L46	46	52.0	61.5	26.0	108.0	83,00
FG 630/L50	50	58.0	68.0	27.0	108.0	93,50
FG 630/L55	55	58.0	72.9	31.0	108.0	130,50
FG 630/L60	60	58.0	79.0	31.0	108.0	150,50
FG 630/L65	65	62.0	87.1	35.0	108.0	171,50
FG 630/L70	70	62.0	93.0	36.0	108.0	194,50

SNODO RINFORZATO CON ATTACCO QUADRO

Acciaio al cromo molibdeno rinforzato
Finitura brunita



CODICE	L/mm	€/PZ
FG 625/SN12R	105	37,50
FG 629/SN34R	105	70,00

RACCORDO CON ATTACCO QUADRO

Acciaio al cromo vanadio
Finitura lucida



CODICE	□	■	L/mm	€/PZ
FG 624/AD1	1/4"	3/8"	28	6,00
FG 624/AD2	3/8"	1/4"	30	7,50
FG 624/AD3	3/8"	1/2"	30	8,50
FG 625/AD1	1/2"	1/4"	28	10,50
FG 625/AD2	1/2"	3/8"	30	11,00
FG 625/AD3	1/2"	3/4"	28	12,50
FG 629/AD3	3/4"	1/2"	30	15,00

RACCORDO MAGNETICO PIATTO

Acciaio al cromo molibdeno rinforzato
Finitura brunita



CODICE	□	■	L/mm	€/PZ
FG 624/AM1	1/4"	3/8"	13.6	9,50
FG 624/AM2	3/8"	1/2"	18.4	12,50
FG 625/AM1	1/2"	3/4"	27.5	19,00

SET



SET 3 RACCORDI MAGNETICI PIATTI

Fornito su supporto in ABS appendibile con ganci a clip e meccanismo finecorsa anticaduta

CODICE	Contenuto □ x ■	€/PZ
FG 625AM/S3	1/4"x3/8"; 3/8"x1/2"; 1/2"x3/4"	49,50

RACCORDO RINFORZATO CON ATTACCO QUADRO

Acciaio al cromo molibdeno rinforzato
Finitura brunita



CODICE	□	■	L/mm	€/PZ
FG 624/AD4	1/4"	3/8"	28	12,50
FG 624/AD5	3/8"	1/2"	30	15,50
FG 628/AD1	1/2"	1/4"	28	11,50
FG 628/AD2	1/2"	3/8"	30	12,00
FG 628/AD3	1/2"	3/4"	28	21,00
FG 629/AD1	3/4"	1/2"	30	29,00
FG 629/AD2	3/4"	1"	28	33,00
FG 629/AS1	FG 629/AD1 - FG 629/AD2			5,00
FG 630/AD1	1"	3/4"	30	46,50
FG 630/AS1	FG 630/AD1			7,50





03

GIRAVITI, INSERTI E PINZE



GIRAVITE A TAGLIO PER VITI CON TESTA A INTAGLIO

Conforme agli standard DIN ISO 2380

Impugnatura bi-materiale

Speciali scanalature laterali che consentono un grip perfetto

Asta in Cromo-Vanadio, con punta brunita e magnetizzata

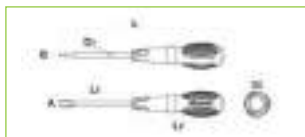

CODICE	AxB mm	D1 x L1 mm	D2 x L2 mm	L/mm	Q.tà min.	€/PZ
FG 22/2.5x60	2.5x0.4	2.5x60	28.9x100.9	161	5	5,30
FG 22/2.5x75	2.5x0.4	2.5x75	28.9x100.9	176	5	5,30
FG 22/3x75	3.0x0.5	3.0x75	28.9x100.9	176	5	5,30
FG 22/3x100	3.0x0.5	3.0x100	28.9x100.9	201	5	5,50
FG 22/3.5x100	3.5x0.6	3.5x100	28.9x100.9	201	5	5,70
FG 22/3.5x125	3.5x0.6	3.5x125	28.9x100.9	226	5	5,80
FG 22/4x100	4.0x0.8	4.0x100	28.9x100.9	201	5	6,00
FG 22/4x125	4.0x0.8	4.0x125	28.9x100.9	226	5	6,20
FG 22/4x150	4.0x0.8	4.0x150	28.9x100.9	251	5	6,30
FG 22/5.5x100	5.5x1.0	5.0x100	32.7x114.0	214	5	6,60
FG 22/5.5x150	5.5x1.0	5.5x150	32.7x114.0	264	5	7,70
FG 22/5.5x200	5.5x1.0	5.5x200	32.7x114.0	314	5	7,70
FG 22/6.5x100	6.5x1.2	6.5x100	36.0x125.0	225	5	8,20
FG 22/6.5x150	6.5x1.2	6.5x150	36.0x125.0	275	5	8,50
FG 22/8x150	8.0x1.2	8.0x150	39.4x136.6	287	3	11,10
FG 22/8x200	8.0x1.2	8.0x200	39.4x136.6	337	3	12,70
FG 22/10x200	10.0x1.6	10.0x200	39.4x136.6	337	3	15,00
FG 22/12x250	12.0x1.7	12.0x250	39.4x136.6	387	3	15,70

GIRAVITE A TAGLIO PER VITI CON TESTA A INTAGLIO - SERIE STUBBY

Conforme agli standard DIN ISO 2380

Impugnatura bi-materiale

Speciali scanalature laterali che consentono un grip perfetto

Asta in Cromo-Vanadio, con punta brunita e magnetizzata



CODICE	AxB mm	D1 x L1 mm	D2 x L2 mm	L/mm	Q.tà min.	€/PZ
FG 22/4x30	4.0x0.8	4x30	35.4x63.5	93.5	5	6,40
FG 22/6.5x30	6.5x1.2	6.5x30	35.4x63.5	93.5	5	6,60

SET**SET GIRAVITI PER VITI CON TESTA AD INTAGLIO**

Conforme agli standard DIN ISO 2380

Impugnatura bi-materiale

Speciali scanalature laterali che consentono un grip perfetto

Asta in Cromo-Vanadio, con punta brunita e magnetizzata

Forniti in set di cartone

CODICE	Contenuto	€/PZ
FG 22SL/S5	2.5x75, 3x75, 4x125, 5.5x150, 6.5x150	36,00
FG 22SL/S9	2.5x60, 3x100, 4x30, 4x125, 5.5x150, 6.5x30, 6.5x150, 8x200, 10x200	78,00
FG 22SL/S12	2.5x60, 3x100, 3.5x125, 4x30, 4x125, 5.5x100, 5.5x150, 6.5x30, 6.5x150, 8x200, 10x200, 12x250	105,00

GIRAVITE A TAGLIO PER VITI CON TESTA A CROCE PHILLIPS

Conforme agli standard DIN ISO 8764

Impugnatura bi-materiale

Speciali scanalature laterali che consentono un grip perfetto

Asta in Cromo-Vanadio, con punta brunita e magnetizzata



CODICE	PH	D1 x L1 mm	D2 x L2 mm	L/mm	Q.tà min.	€/PZ
FG 22/PH0x60	0	3x60	28.9x101	160	5	5,30
FG 22/PH1x80	1	5x80	32.7x114	194	5	6,80
FG 22/PH1x150	1	5x150	32.7x114	264	5	6,90
FG 22/PH1x200	1	5x200	32.7x114	314	5	8,00
FG 22/PH2x100	2	6x100	36.0x125	225	5	8,40
FG 22/PH2x150	2	6x150	36.0x125	275	5	9,00
FG 22/PH2x200	2	6x200	36.0x129	325	5	9,50
FG 22/PH3x150	3	8x150	39.4x137	287	3	11,40
FG 22/PH4x200	4	9.5x200	39.4x137	337	3	14,70

GIRAVITE A TAGLIO PER VITI CON TESTA A CROCE PHILLIPS - SERIE STUBBY

Conforme agli standard DIN ISO 8764

Impugnatura bi-materiale

Speciali scanalature laterali che consentono un grip perfetto

Asta in Cromo-Vanadio, con punta brunita e magnetizzata



CODICE	PH	D1 x L1 mm	D2 x L2 mm	L/mm	Q.tà min.	€/PZ
FG 22/PH1x30	1	5x30	35.4x63.5	93.5	5	6,30
FG 22/PH2x30	2	6x30	35.4x63.5	93.5	5	6,70

SET



SET GIRAVITI PER VITI CON TESTA A CROCE PHILLIPS

Conforme agli standard DIN ISO 8764

Impugnatura bi-materiale

Speciali scanalature laterali che consentono un grip perfetto

Asta in Cromo-Vanadio, con punta brunita e magnetizzata

Forniti in set di cartone

CODICE	Contenuto	€/PZ
FG 22PH/S4	PH0X60, PH1X80, PH2X100, PH3X150	35,70
FG 22PH/S6	PH0X60, PH1X80, PH1X150, PH2X100, PH3X150, PH4X200	56,70
FG 22PH/S8	PH0X60, PH1X30, PH1X80, PH1X150, PH2X30, PH2X100, PH3X150, PH4X200	71,40

GIRAVITE A TAGLIO PER VITI CON TESTA A CROCE POZIDRIV

Conforme agli standard DIN ISO 8764

Impugnatura bi-materiale

Speciali scanalature laterali che consentono un grip perfetto

Asta in Cromo-Vanadio, con punta brunita e magnetizzata

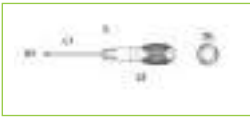

CODICE	PZ	D1 x L1 mm	D2 x L2 mm	L/mm	Q.tà min.	€/PZ
FG 22/PZ0x60	0	3x60	29.9x101	161	5	5,60
FG 22/PZ1x80	1	5x80	32.7x114	194	5	6,80
FG 22/PZ2x100	2	6x100	36.0x125	225	5	8,00
FG 22/PZ3x150	3	8x150	39.4x135	286	3	11,60
FG 22/PZ4x200	4	9.5x200	39.4x137	337	3	14,30

GIRAVITE A TAGLIO PER VITI CON TESTA A CROCE POZIDRIV - SERIE STUBBY

Conforme agli standard DIN ISO 8764

Impugnatura bi-materiale

Speciali scanalature laterali che consentono un grip perfetto

Asta in Cromo-Vanadio, con punta brunita e magnetizzata



CODICE	PZ	D1 x L1 mm	D2 x L2 mm	L/mm	Q.tà min.	€/PZ
FG 22/PZ1x30	1	5x30	35.4x63.5	93.5	5	6,30
FG 22/PZ2x30	2	6x30	35.4x63.5	93.5	5	6,50

SET



SET GIRAVITI PER VITI CON TESTA A CROCE POZIDRIV

Conforme agli standard DIN ISO 8764

Impugnatura bi-materiale

Speciali scanalature laterali che consentono un grip perfetto

Asta in Cromo-Vanadio, con punta brunita e magnetizzata

Forniti in set di cartone

CODICE	Contenuto	€/PZ
FG 22PZ/S4	PZ0x60, PZ1x80, PZ2x100, PZ3x150	34,70
FG 22PZ/S5	PZ0x60, PZ1x80, PZ2x100, PZ3x150, PZ4x200	49,40
FG 22PZ/S7	PZ0x60, PZ1x30, PZ1x80, PZ2x30, PZ2x100, PZ3x150, PZ4x200	63,00



SET GIRAVITI PER VITI CON TESTA A INTAGLIO E A CROCE PHILLIPS

Impugnatura bi-materiale

Speciali scanalature laterali che consentono un grip perfetto

Asta in Cromo-Vanadio, con punta brunita e magnetizzata

Forniti in set di cartone

CODICE	Contenuto	€/PZ
FG 22/S6	3x75, 4x100, 5.5x100, PH0x60, PH1x80, PH2x100	36,00
FG 22/S8	3x75, 4x100, 5.5x100, 6.5x30, PH0x60, PH1x80, PH2x100, PH2x30	48,00
FG 22/S8B	2.5x75, 3.5x100, 4x100, 6.5x150, 8x150, PH0x60, PH1x80, PH2x150	52,00



SET GIRAVITI PER VITI CON TESTA A INTAGLIO E A CROCE PHILLIPS

Impugnatura bi-materiale

Speciali scanalature laterali che consentono un grip perfetto

Asta in Cromo-Vanadio, con punta brunita e magnetizzata

Forniti in set di cartone

CODICE	Contenuto	€/PZ
FG 22/S10	2.5x60, 3x75, 4x100, 5.5x150, 6.5x150, 4x30, PH0x60, PH1x80, PH2x100, PH1x30	65,00
FG 22/S12	2.5x60, 3x75, 4x100, 5.5x150, 6.5x150, 8x150, 4x30, PH0x60, PH1x80, PH2x100, PH3x150, PH1x30	90,00





SET GIRAVITI PER VITI CON TESTA A INTAGLIO E A CROCE POZIDRIV

Impugnatura bi-materiale
Speciali scanalature laterali che consentono un grip perfetto
Asta in Cromo-Vanadio, con punta brunita e magnetizzata
Forniti in set di cartone

CODICE	Contenuto	€/PZ
FG 22/S7	3x75, 4x100, 5.5x150, 6.5x150, PZ0x60, PZ1x80, PZ2x100	50,00

GIRAVITE CON ESAGONO DI MANOVRA

Conforme agli standard DIN ISO 2380
Impugnatura bi-materiale
Speciali scanalature laterali che consentono un grip perfetto
Asta in Cromo-Vanadio, con punta brunita e magnetizzata

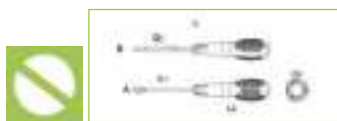

CODICE	AxB mm	D1 x L1 mm	D2 x L2 mm	L/mm	Q.tà min.	€/PZ
FG 22/5.5x125H	5.5x1.0	5.5x125	36.0x125	250	3	6,70
FG 22/6.5x150H	6.5x1.2	6.5x150	39.4x137	287	3	8,80
FG 22/8x175H	8.0x1.2	8x175	39.4x137	312	3	10,90
FG 22/10x200H	10x1.6	9.5x200	39.4x137	337	2	13,40
FG 22/12x200H	12x1.8	12x200	39.4x137	337	2	15,00

GIRAVITE CON ESAGONO DI MANOVRA

Conforme agli standard DIN ISO 2380
Impugnatura bi-materiale
Speciali scanalature laterali che consentono un grip perfetto
Asta in Cromo-Vanadio, con punta brunita e magnetizzata

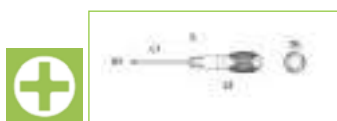

CODICE	PH	D1 x L1 mm	D2 x L2 mm	L/mm	Q.tà min.	€/PZ
FG 22/PH2x100H	2	8x100	39.4x137	237	3	10,00
FG 22/PH3x150H	3	8x150	39.4x137	287	3	11,60
FG 22/PH4x200H	4	9.5x200	39.4x137	337	2	15,30

SET



SET GIRAVITI CON ESAGONO DI MANOVRA PER VITI CON TESTA A INTAGLIO E A CROCE PHILLIPS

Impugnatura bi-materiale
Speciali scanalature laterali che consentono un grip perfetto
Asta in Cromo-Vanadio, con punta brunita e magnetizzata
Forniti in set di cartone

CODICE	Contenuto	€/PZ
FG 22/S8H	5.5x125, 6.5x150, 8x175, 10x200, 12x200, PH2x100, PH3x150, PH4x200	95,00

GIRAVITE A LAMA EXTRA LUNGA

Impugnatura bi-materiale
Speciali scanalature laterali che consentono un grip perfetto
Asta in Cromo-Vanadio, con punta brunita e magnetizzata



CODICE	AxB mm	D1 x L1 mm	D2 x L2 mm	L/mm	Q.tà min.	€/PZ
FG 22/2.5x200	2.5x0.4	2.5x200	28.9x114	300	3	7,70
FG 22/2.5x300	2.5x0.4	3x300	28.9x100.9	400	3	9,20
FG 22/4x400	4.0x0.8	4x400	28.9x100.9	500	3	11,60
FG 22/5x400	7.5x1.0	5x400	28.9x100.9	514	3	13,40
FG 22/6x400	8.8x1.2	6.5x400	28.9x100.9	525	3	16,70

GIRAVITE A LAMA EXTRA LUNGA

Impugnatura bi-materiale
Speciali scanalature laterali che consentono un grip perfetto
Asta in Cromo-Vanadio, con punta brunita e magnetizzata



CODICE	PH	D1 x L1 mm	D2 x L2 mm	L/mm	Q.tà min.	€/PZ
FG 22/PH0x300	0	3x300	28.9x100	400	3	8,40
FG 22/PH1x400	1	5x400	32.7x114	514	3	12,60
FG 22/PH2x400	2	6x400	36.0x125	525	3	15,30

SET



SET GIRAVITI EXTRA-LUNGI PER VITI CON TESTA A INTAGLIO E A CROCE PHILLIPS

Impugnatura bi-materiale

Speciali scanalature laterali che consentono un grip perfetto

Asta in Cromo-Vanadio, con punta brunita e magnetizzata

Forniti in set di cartone

CODICE	Contenuto	€/PZ
FG 22XL/S6	2.5X200, 4X400, 5X400, 6.5X400, PH0X300, PH1X400	70,40
FG 22XL/S8	2.5X200, 2.5X300, 4X400, 5X400, 6.5X400, PH0X300, PH1X400, PH2X400	96,60

GIRAVITE ANGOLARE

Impugnatura in materiale plastico

Asta in Cromo-Vanadio



CODICE	mm	L/mm	Q.tà min.	€/PZ
FG 22/OF4	4.0x4.0	100	3	5,10
FG 22/OF5	5.5x5.5	125	3	5,60
FG 22/OF8	8.0x8.0	150	3	7,90

GIRAVITE ANGOLARE

Impugnatura in materiale plastico

Asta in Cromo-Vanadio



CODICE	PH	L/mm	Q.tà min.	€/PZ
FG 22/PH12	PH1 - PH2	125	3	5,70
FG 22/PH34	PH3 - PH4	200	3	10,80

GIRAVITE CON IMPRONTA ESAGONALE SFERICA

Impugnatura bi-materiale

Speciali scanalature laterali che consentono un grip perfetto

Asta in Cromo-Vanadio, con punta brunita e magnetizzata



CODICE	mm	D1 x L1 mm	D2 x L2 mm	L/mm	Q.tà min.	€/PZ
FG 22/H2	2	2.0x75	28.9x101	176	3	6,30
FG 22/H2.5	2.5	2.5x75	28.9x101	176	3	6,50
FG 22/H3	3	3x100	28.9x101	201	3	6,60
FG 22/H4	4	4x100	28.9x101	201	3	7,40
FG 22/H5	5	5.0x100	32.7x114	214	3	8,40
FG 22/H6	6	6.0x125	36.0x125	250	2	9,50
FG 22/H8	8	8.0x150	39.4x136.6	287	2	12,10

SET



SET 7 GIRAVITI CON TESTA ESAGONALE SFERICA

Impugnatura bi-materiale

Speciali scanalature laterali che consentono un grip perfetto

Asta in Cromo-Vanadio, con punta brunita e magnetizzata

Forniti in set di cartone

CODICE	Contenuto	€/PZ
FG 22H/S7	2, 2.5, 3, 4, 5, 6, 8	57,80

GIRAVITE PER VITI CON IMPRONTA TORX

Impugnatura bi-materiale

Speciali scanalature laterali che consentono un grip perfetto

Asta in Cromo-Vanadio, con punta brunita e magnetizzata



CODICE	TX	D1 x L1 mm	D2 x L2 mm	L/mm	Q.tà min.	€/PZ
FG 22/TX6	6	4.0x75	28.9x101	176	5	7,20
FG 22/TX7	7	4.0x75	28.9x101	176	5	7,20
FG 22/TX8	8	4.0x75	28.9x101	176	5	8,40
FG 22/TX9	9	4.0x75	28.9x101	176	5	8,40
FG 22/TX10	10	5.0X100	32.7X114	214	5	9,80
FG 22/TX15	15	5.0X100	32.7X114	214	5	9,80
FG 22/TX20	20	5.0X100	32.7X114	214	5	9,80
FG 22/TX25	25	6.0X100	36.0X125	225	5	11,10
FG 22/TX27	27	6.0X100	36.0X125	225	5	11,10
FG 22/TX30	30	6.0X100	36.0X125	225	5	11,10
FG 22/TX40	40	7.0X100	36.0X125	225	3	12,60
FG 22/TX45	45	8.0X100	39.4X136.6	237	3	14,20

SET



SET GIRAVITI PER VITI CON IMPRONTA TORX

Impugnatura bi-materiale

Speciali scanalature laterali che consentono un grip perfetto

Asta in Cromo-Vanadio, con punta brunita e magnetizzata

Forniti in set di cartone

CODICE	Contenuto	€/PZ
FG 22TX/S6	TX10, TX15, TX20, TX25, TX27, TX30	65,00





SET GIRAVITI PER VITI CON IMPRONTA TORX

Impugnatura bi-materiale

Speciali scanalature laterali che consentono un grip perfetto

Asta in Cromo-Vanadio, con punta brunita e magnetizzata

Forniti in set di cartone

CODICE	Contenuto	€/PZ
FG 22TX/S8	TX10, TX15, TX20, TX25, TX27, TX30, TX40, TX45	90,30
FG 22TX/S12	TX6, TX7, TX8, TX9, TX10, TX15, TX20, TX25, TX27, TX30, TX40, TX45	120,80

GIRAVITE PER VITI CON IMPRONTA TAMPER RESISTANT TORX

Impugnatura bi-materiale

Speciali scanalature laterali che consentono un grip perfetto

Asta in Cromo-Vanadio, con punta brunita e magnetizzata



CODICE	TX	D1 x L1 mm	D2 x L2 mm	L/mm	Q.tà min.	€/PZ
FG 22/RTX6	6	4.0x75	28.9x101	176	3	9,10
FG 22/RTX7	7	4.0x75	28.9x101	176	3	9,10
FG 22/RTX8	8	4.0x75	28.9x101	176	3	9,10
FG 22/RTX9	9	4.0x75	28.9x101	176	3	9,10
FG 22/RTX10	10	5.0x100	32.7x114	214	3	9,90
FG 22/RTX15	15	5.0x100	32.7x114	214	3	10,20
FG 22/RTX20	20	5.0x100	32.7x114	214	3	10,50
FG 22/RTX25	25	6.0x100	36.0x125	225	3	10,90
FG 22/RTX27	27	6.0x100	36.0x125	225	3	11,20
FG 22/RTX30	30	6.0x100	36.0x125	225	3	12,10
FG 22/RTX40	40	7.0x100	36.0x125	225	2	12,50
FG 22/RTX45	45	8.0x100	39.4x136.6	237	2	14,20

SET



SET GIRAVITI PER VITI CON IMPRONTA TAMPER RESISTANT TORX

Impugnatura bi-materiale

Speciali scanalature laterali che consentono un grip perfetto

Asta in Cromo-Vanadio, con punta brunita e magnetizzata

Forniti in set di cartone

CODICE	Contenuto	€/PZ
FG 22RTX/S6	RTX10, RTX15, RTX20, RTX25, RTX27, RTX30	69,30



SET GIRAVITI PER VITI CON IMPRONTA TAMPER RESISTANT TORX

Impugnatura bi-materiale

Speciali scanalature laterali che consentono un grip perfetto

Asta in Cromo-Vanadio, con punta brunita e magnetizzata

Forniti in set di cartone

CODICE	Contenuto	€/PZ
FG 22RTX/S8	RTX10, RTX15, RTX20, RTX25, RTX27, RTX30, RTX40, RTX45	94,50
FG 22RTX/S12	RTX6, RTX7, RTX8, RTX9, RTX10, RTX15, RTX20, RTX25, RTX27, RTX30, RTX40, RTX45	132,00

GIRAVITE PER VITI CON IMPRONTA TORX - SERIE EXTRA-LUNGA

Impugnatura bi-materiale

Speciali scanalature laterali che consentono un grip perfetto

Asta in Cromo-Vanadio, con punta brunita e magnetizzata



CODICE	TX	D1 x L1 mm	D2 x L2 mm	L/mm	Q.tà min.	€/PZ
FG 22XL/TX6	6	4.0X400	28.9X101	501	3	11,70
FG 22XL/TX7	7	4.0X400	28.9X101	501	3	11,70
FG 22XL/TX8	8	4.0X400	28.9X101	501	3	11,70
FG 22XL/TX9	9	4.0X400	28.9X101	501	3	11,70
FG 22XL/TX10	10	5.0X400	32.7X114	514	3	14,20
FG 22XL/TX15	15	5.0X400	32.7X114	514	3	14,20
FG 22XL/TX20	20	5.0X400	32.7X114	514	3	14,20
FG 22XL/TX25	25	6.0X400	36.0X125	525	3	17,80
FG 22XL/TX27	27	6.0X400	36.0X125	525	3	17,80
FG 22XL/TX30	30	6.0X400	36.0X125	525	3	17,80
FG 22XL/TX40	40	7.0X400	36.0X125	525	3	17,80

SET



SET GIRAVITI PER VITI CON IMPRONTA TORX - SERIE EXTRA-LUNGA

Impugnatura bi-materiale

Speciali scanalature laterali che consentono un grip perfetto

Asta in Cromo-Vanadio, con punta brunita e magnetizzata

Forniti in set di cartone

CODICE	Contenuto	€/PZ
FG 22TX/LS8	TX8, 10, 15, 20, 25, 27, 30, 40	122,00
FG 22TX/LS11	TX6, 7, 8, 9, 10, 15, 20, 25, 27, 30, 40	155,00

GIRAVITE A BUSSOLA ESAGONALE CON ASTA FLESSIBILE RIVESTITA IN GOMMA

Conforme agli standard DIN ISO 3125

Impugnatura bi-materiale

Speciali scanalature laterali che consentono un grip perfetto



CODICE	mm	D1 x L1 mm	D2 x L2 mm	L/mm	Q.tà min.	€/PZ
FG 22/FL5	5	6.0X150	36.0X125	275	5	21,70
FG 22/FL5.5	5.5	6.0X150	36.0X125	275	5	21,70
FG 22/FL6	6	6.0X150	36.0X125	275	5	21,70
FG 22/FL7	7	6.0X150	36.0X125	275	5	21,70
FG 22/FL8	8	6.0X150	36.0X125	275	3	21,70
FG 22/FL10	10	6.0X150	36.0X125	275	3	21,70

SET



SET GIRAVITI A BUSSOLA ESAGONALE CON ASTA FLESSIBILE RIVESTITA IN GOMMA

Conforme agli standard DIN ISO 3125

Impugnatura bi-materiale

Speciali scanalature laterali che consentono un grip perfetto

Forniti in set di cartone

CODICE	Contenuto	€/PZ
FG 22FL/S6	5, 5.5, 6, 7, 8, 10 mm	132,00

GIRAVITE A BUSSOLA ESAGONALE CON ASTA FISSA

Conforme agli standard DIN ISO 3125

Impugnatura bi-materiale

Speciali scanalature laterali che consentono un grip perfetto



CODICE	mm	D1 x L1 mm	D2 x L2 mm	L/mm	Q.tà min.	€/PZ
FG 22/FX5	5	6.0X125	36.0X125	250	5	12,60
FG 22/FX5.5	5.5	6.0X125	36.0X125	250	5	12,60
FG 22/FX6	6	6.0X125	36.0X125	250	5	12,60
FG 22/FX7	7	6.0X125	36.0X125	250	5	14,20
FG 22/FX8	8	6.0X125	36.0X125	250	5	14,20

CODICE	mm	D1 x L1 mm	D2 x L2 mm	L/mm	Q.tà min.	€/PZ
FG 22/FX9	9	6.0X125	36.0X125	250	5	14,20
FG 22/FX10	10	6.0X125	36.0X125	250	5	15,30
FG 22/FX11	11	6.0X125	36.0X125	250	5	15,30
FG 22/FX12	12	6.0X125	36.0X125	250	3	15,30
FG 22/FX13	13	6.0X125	36.0X125	250	3	16,80

SET



SET GIRAVITI A BUSSOLA ESAGONALE CON ASTA FISSA

Conforme agli standard DIN ISO 3125

Impugnatura bi-materiale

Speciali scanalature laterali che consentono un grip perfetto

Forniti in set di cartone

CODICE	Contenuto	€/PZ
FG 22FX/S6	6, 7, 8, 9, 10, 12mm	89,80
FG 22FX/S9B	5, 5.5, 7, 8, 9, 10, 12, 13 mm	131,80
FG 22FX/S10	5, 5.5, 6, 7, 8, 9, 10, 11, 12, 13 mm	147,00



CHIAVE MASCHIO A L CON IMPRONTA ESAGONALE - SERIE CORTA

Finitura brunita



CODICE	mm	L1/mm	L2mm	Q.tà min.	€/PZ
FG 139/B1,5	1.5	46.5	15.5	5	0,50
FG 139/B2	2.0	52.0	18.0	5	0,50
FG 139/B2.5	2.5	58.5	20.5	5	0,60
FG 139/B3	3.0	66.0	23.0	5	0,60
FG 139/B4	4.0	74.0	29.0	5	0,70
FG 139/B4.5	4.5	80.0	30.5	5	0,70
FG 139/B5	5.0	85.0	33.0	5	0,80
FG 139/B5.5	5.5	90.5	35.5	5	0,80
FG 139/B6	6.0	96.0	38.0	5	1,40
FG 139/B7	7.0	102.0	41.0	5	1,70
FG 139/B8	8.0	108.0	44.0	5	1,80
FG 139/B9	9.0	111.0	46.0	5	2,20
FG 139/B10	10.0	122.0	50.0	5	2,70
FG 139/B11	11.0	126.0	52.0	5	4,00
FG 139/B12	12.0	137.0	57.0	2	5,70
FG 139/B13	13.0	142.0	62.0	2	5,80
FG 139/B14	14.0	154.0	70.0	2	8,30
FG 139/B16	16.0	165.0	75.0	2	9,30
FG 139/B17	17.0	177.0	80.0	2	12,90
FG 139/B19	19.0	199.0	89.0	2	18,10
FG 139/B22	22.0	216.0	100.0	2	27,90
FG 139/B24	24.0	242.0	112.0	1	33,00
FG 139/B27	27.0	271.0	125.0	1	43,30
FG 139/B30	30.0	309.0	140.0	1	67,00
FG 139/B32	30.0	341.0	155.0	1	92,70
FG 139/B36	36.0	385.0	174.0	1	123,60



FASANO[®]
TOOLS



SET 10 CHIAVI MASCHIO ESAGONALI A L - SERIE CORTA

Finitura brunita

CODICE	Contenuto	€/PZ
FG 139/B	1.5, 2, 2.5, 3, 4, 5, 5.5, 6, 8, 10 mm	16,50

CHIAVE MASCHIO A L CON IMPRONTA ESAGONALE - SERIE LUNGA

Finitura brunita



CODICE	mm	L1/mm	L2mm	Q.tà min.	€/PZ
FG 139/C1.5	1.5	63.5	15.5	5	0,90
FG 139/C2	2.0	77.0	18.0	5	1,00
FG 139/C2.5	2.5	87.5	20.5	5	1,10
FG 139/C3	3.0	93.0	23.0	5	1,20
FG 139/C4	4.0	104.0	29.0	5	1,50
FG 139/C4.5	4.5	114.5	30.5	5	1,70
FG 139/C5	5.0	120.0	33.0	5	1,70
FG 139/C5.5	5.5	134.0	35.5	5	1,80
FG 139/C6	6.0	141.0	38.0	5	2,20
FG 139/C7	7.0	147.0	41.0	5	2,70
FG 139/C8	8.0	158.0	44.0	5	3,30
FG 139/C10	10.0	180.0	50.0	5	5,40
FG 139/C12	12.0	202.0	57.0	2	7,10
FG 139/C14	14.0	229.0	70.0	2	9,80
FG 139/C17	17.0	262.0	80.0	2	18,10
FG 139/C19	19.0	289.0	89.0	2	18,40

SET



SET 10 CHIAVI MASCHIO ESAGONALI A L - SERIE LUNGA

Finitura brunita

CODICE	Contenuto	€/PZ
FG 139/C	1.5, 2, 2.5, 3, 4, 5, 5.5, 6, 8, 10 mm	23,70

SET 10 CHIAVI MASCHIO ESAGONALI A L

Serie speciale con punta magnetizzata



CODICE	Contenuto	€/PZ
FG 139/LM	1.5, 2, 2.5, 3, 4, 5, 6, 7, 8, 10 mm	52,00

CHIAVE MASCHIO A L CON IMPRONTA ESAGONALE SFERICA - SERIE CORTA

Finitura brunita



CODICE	mm	L1/mm	L2mm	Q.tà min.	€/PZ
FG 139/1.5	1.5	77.0	14.0	5	1,50
FG 139/2	2.0	83.0	16.0	5	1,60
FG 139/2.5	2.5	90.0	18.0	5	1,60
FG 139/3	3.0	98.0	20.0	5	1,60
FG 139/4	4.0	106.0	24.0	5	1,80
FG 139/4.5	4.5	112.0	26.0	5	2,10
FG 139/5	5.0	118.0	28.0	5	2,10
FG 139/5.5	5.5	128.0	30.0	5	2,90
FG 139/6	6.0	137.0	32.0	5	2,90
FG 139/7	7.0	147.0	34.0	5	4,00
FG 139/8	8.0	156.0	36.0	5	5,10
FG 139/10	10.0	170.0	40.0	5	6,00

SET



SET 12 CHIAVI MASCHIO A L CON IMPRONTA ESAGONALE SFERICA - SERIE CORTA

Finitura brunita

CODICE	Contenuto	€/PZ
FG 139	1.5 - 10.0mm	36,00

SET 8 CHIAVI MASCHIO CON IMPRONTA ESAGONALE SFERICA - SERIE CORTA

Finitura brunita



CODICE	Contenuto	€/PZ
FG 139C/FS	1.5, 2, 2.5, 3, 4, 5, 6, 8mm	24,00

CHIAVE MASCHIO A L CON IMPRONTA ESAGONALE SFERICA - SERIE LUNGA

Finitura brunita



CODICE	mm	L1/mm	L2mm	Q.tà min.	€/PZ
FG 139/L1.5	1.5	90.0	14.0	5	2,20
FG 139/L2	2.0	100.0	16.0	5	2,30
FG 139/L2.5	2.5	112.0	18.0	5	2,30
FG 139/L3	3.0	125.0	20.0	5	2,40
FG 139/L4	4.0	140.0	24.0	5	2,70
FG 139/L4.5	4.5	112.0	26.0	5	3,30
FG 139/L5	5.0	158.0	28.0	5	3,30
FG 139/L5.5	5.5	168.0	30.0	5	3,30
FG 139/L6	6.0	178.0	32.0	5	4,20
FG 139/L7	7.0	188.0	34.0	5	4,40
FG 139/L8	8.0	200.0	36.0	5	4,60
FG 139/L10	10.0	224.0	40.0	5	6,60
FG 139/L12	12.0	224.0	40.0	5	8,80
FG 139/L14	14.0	240.0	50.0	5	14,00
FG 139/L17	17.0	260.0	55.0	5	22,20
FG 139/L19	19.0	285.0	75.0	5	28,90

SET



SET 12 CHIAVI MASCHIO A L CON IMPRONTA SFERICA - SERIE LUNGA

Finitura brunita

CODICE	Contenuto	€/PZ
FG 139/L	1.5 - 10.0mm	40,00



CHIAVE MASCHIO A L CON IMPRONTA ESAGONALE SFERICA - SERIE IN POLLICI

Finitura brunita



CODICE	mm	L1/mm	L2mm	Q.tà min.	€/PZ
FG 139IN/0.05	0.05	72.0	12.0	5	0,90
FG 139IN5/64	5/64"	77.0	14.0	5	1,10
FG 139IN3/32	3/32"	82.0	15.0	5	1,20
FG 139IN7/64	7/64"	88.0	17.0	5	1,30
FG 139IN1/8	1/8"	92.0	18.0	5	1,30
FG 139IN9/64	9/64"	96.0	19.0	5	1,50
FG 139IN5/32	5/32"	101.0	20.0	5	1,50
FG 139IN1/6	1/6"	105.0	21.0	5	1,60
FG 139IN3/16	3/16"	114.0	24.0	5	1,60
FG 139IN7/32	7/32"	124.0	26.0	5	1,80
FG 139IN1/4	1/4"	135.0	28.0	5	2,00
FG 139IN5/16	5/16"	151.0	32.0	5	2,50
FG 139IN3/8	3/8"	170.0	35.0	5	3,00

SET



SET 13 CHIAVI MASCHIO A L CON IMPRONTA ESAGONALE SFERICA - IN POLLICI

Finitura brunita

CODICE	Contenuto	€/PZ
FG 139/IN	0.05 - 3/8"	38,00

SET 9 CHIAVI MASCHIO CON IMPRONTA ESAGONALE - SERIE IN POLLICI

Finitura brunita



CODICE	Contenuto	€/PZ
FG 139FS/IN	5/64, 3/32, 7/64, 1/8, 9/64, 5/32, 3/16, 7/32, 1/4"	24,00

CHIAVE MASCHIO A L CON IMPRONTA TORX - SERIE CORTA

Finitura brunita



CODICE	mm	L1/mm	L2mm	Q.tà min.	€/PZ
FG 138/TX7	7	80.0	16.0	5	4,20
FG 138/TX8	8	80.0	16.0	5	4,20
FG 138/TX9	9	80.0	16.0	5	4,20
FG 138/TX10	10	86.0	17.0	5	4,30
FG 138/TX15	15	90.0	18.0	5	4,30
FG 138/TX20	20	95.0	19.0	5	4,30
FG 138/TX25	25	100.0	20.0	5	4,50
FG 138/TX27	27	105.0	22.0	5	4,60
FG 138/TX30	30	114.0	24.0	5	5,20
FG 138/TX40	40	124.0	26.0	5	5,60
FG 138/TX45	45	133.0	29.0	5	7,80
FG 138/TX50	50	152.0	32.0	5	8,20

SET



SET 12 CHIAVI MASCHIO A L CON IMPRONTA TORX

Finitura brunita

CODICE	Contenuto	€/PZ
FG 138	TX7, 8, 9, 10, 15, 20, 25, 27, 30, 40, 45, 50	55,00

SET 8 CHIAVI MASCHIO A L CON IMPRONTA TORX

Finitura brunita



CODICE	Contenuto	€/PZ
FG 138C/FS	TX9 - TX40	31,00

SET



SET 6 CHIAVI MASCHIO A L CON IMPRONTA TORX
Finitura brunita

CODICE	Contenuto	€/PZ
FG 138/S9	TX8 - TX40	26,00



SET 10 CHIAVI MASCHIO A L CON IMPRONTA TORX
Finitura brunita

CODICE	Contenuto	€/PZ
FG 138/B	TX9 - TX50 - SERIE CORTA	34,00
FG 138/C	TX9 - TX50 - SERIE LUNGA	37,00

SET 10 CHIAVI MASCHIO A L CON IMPRONTA TORX
Serie speciale con punta magnetizzata



CODICE	Contenuto	€/PZ
FG 138/M	TX10 - TX50	60,00

CHIAVE MASCHIO A L CON IMPRONTA TORX E TESTA SFERICA
Finitura brunita



CODICE	mm	L1/mm	L2mm	Q.tà min.	€/PZ
FG 138BP/TX8	8	80.0	16.0	5	4,80
FG 138BP/TX9	9	80.0	16.0	5	4,80
FG 138BP/TX10	10	86.0	17.0	5	4,90
FG 138BP/TX15	15	90.0	18.0	5	4,90

CODICE	mm	L1/mm	L2mm	Q.tà min.	€/PZ
FG 138BP/TX20	20	95.0	19.0	5	5,00
FG 138BP/TX25	25	100.0	20.0	5	5,10
FG 138BP/TX27	27	105.0	22.0	5	5,20
FG 138BP/TX30	30	114.0	24.0	5	5,50
FG 138BP/TX40	40	124.0	26.0	5	6,20
FG 138BP/TX45	45	133.0	29.0	5	8,40
FG 138BP/TX50	50	152.0	32.0	5	8,90

SET



SET DI 9 CHIAVI MASCHIO TORX A L E TESTA SFERICA
Finitura brunita

CODICE	Contenuto	€/PZ
FG 138/BP	TX8, 10, 15, 20, 25, 27, 30, 40, 50	60,00

CHIAVE MASCHIO A L CON IMPRONTA TAMPER RESISTANT TORX
Finitura brunita



CODICE	TX	L1/mm	L2mm	Q.tà min.	€/PZ
FG 137/TRX7	7	80.0	16.0	5	4,70
FG 137/TRX8	8	80.0	16.0	5	4,70
FG 137/TRX9	9	80.0	16.0	5	4,70
FG 137/TRX10	10	86.0	17.0	5	4,70
FG 137/TRX15	15	90.0	18.0	5	4,80
FG 137/TRX20	20	95.0	19.0	5	4,80
FG 137/TRX25	25	100.0	20.0	5	4,90
FG 137/TRX27	27	105.0	22.0	5	5,00
FG 137/TRX30	30	114.0	24.0	5	5,40
FG 137/TRX40	40	124.0	26.0	5	6,10
FG 137/TRX45	45	133.0	29.0	5	6,10
FG 137/TRX50	50	152.0	32.0	5	6,80

SET



SET 12 CHIAVI MASCHIO A L TAMPER RESISTANT TORX
Finitura brunita

CODICE	Contenuto	€/PZ
FG 137	TRX7 - TRX50	58,00



SET 9 CHIAVI MASCHIO A L ESAGONALI SERIE 110° E LATO EXTRA CORTO

Finitura zinco-cromata



CODICE	Contenuto	€/PZ
FG 139/S9	1.5 - 10.0mm	41,00

CHIAVE MASCHIO A L CON IMPRONTA ESAGONALE - SERIE CORTA ZINCOCROMATA

Finitura zinco-cromata



CODICE	mm	L1/mm	L2mm	Q.tà min.	€/PZ
FG 139/D1.5	1.5	46.5	15.5	5	0,80
FG 139/D2	2.0	52.0	18.0	5	0,80
FG 139/D2.5	2.5	58.5	20.5	5	0,80
FG 139/D3	3.0	66.0	23.0	5	1,00
FG 139/D4	4.0	74.0	29.0	5	1,10
FG 139/D4.5	4.5	80.0	30.5	5	1,10
FG 139/D5	5.0	85.0	33.0	5	1,40
FG 139/D5.5	5.5	90.5	35.5	5	1,60
FG 139/D6	6.0	96.0	38.0	5	1,60
FG 139/D7	7.0	102.0	41.0	5	2,10
FG 139/D8	8.0	108.0	44.0	5	2,40
FG 139/D9	9.0	111.0	46.0	5	2,90
FG 139/D10	10.0	122.0	50.0	5	3,70
FG 139/D11	11.0	126.0	52.0	5	4,60
FG 139/D12	12.0	137.0	57.0	2	5,20
FG 139/D13	13.0	142.0	62.0	2	6,70
FG 139/D14	14.0	154.0	70.0	2	7,50
FG 139/D16	16.0	165.0	75.0	2	11,40
FG 139/D17	17.0	177.0	80.0	2	11,90
FG 139/D19	19.0	199.0	89.0	2	16,00
FG 139/D22	22.0	216.0	100.0	2	24,30
FG 139/D24	24.0	242.0	112.0	1	30,90
FG 139/D27	27.0	271.0	125.0	1	42,80
FG 139/D30	30.0	309.0	140.0	1	54,10
FG 139/D32	30.0	341.0	155.0	1	76,30
FG 139/D36	36.0	385.0	174.0	1	108,20



FASANO
TOOLS

SET



SET 10 CHIAVI MASCHIO ESAGONALI A L - SERIE CORTA

Finitura zinco-cromata

CODICE	Contenuto	€/PZ
FG 139/D	1.5, 2, 2.5, 3, 4, 5, 5.5, 6, 8, 10	21,70

CHIAVE MASCHIO A L ESAGONALE - SERIE LUNGA E ZINCOCROMATA

Finitura zinco-cromata



CODICE	mm	L1/mm	L2mm	Q.tà min.	€/PZ
FG 139/E1.5	1.5	63.5	15.5	5	1,50
FG 139/E2	2.0	77.0	18.0	5	1,50
FG 139/E2.5	2.5	87.5	20.5	5	1,70
FG 139/E3	3.0	93.0	23.0	5	1,70
FG 139/E4	4.0	104.0	29.0	5	1,90
FG 139/E5	5.0	120.0	33.0	5	2,30
FG 139/E5.5	5.5	134.0	35.5	5	2,50
FG 139/E6	6.0	141.0	38.0	5	2,50
FG 139/E7	7.0	147.0	41.0	5	2,70
FG 139/E8	8.0	158.0	44.0	5	3,30
FG 139/E10	10.0	180.0	50.0	5	5,10
FG 139/E12	12.0	202.0	57.0	2	6,70
FG 139/E14	14.0	229.0	70.0	2	9,50
FG 139/E17	17.0	262.0	80.0	2	16,00
FG 139/E19	19.0	289.0	89.0	2	22,20

SET



SET 10 CHIAVI MASCHIO ESAGONALI A L - SERIE LUNGA

Finitura zinco-cromata

CODICE	Contenuto	€/PZ
FG 139/E	1.5, 2, 2.5, 3, 4, 5, 5.5, 6, 8, 10	33,00

INSERTO DA 1/4" PER VITI CON TESTA A INTAGLIO

Conforme agli standard DIN ISO 3126 - C6.3

Materiale: Cromo-Vanadio S2



CODICE	mm	L/mm	Q.tà min.	€/PZ
FG 85/25F1	0.5x3	25	3	1,30
FG 85/25F2	0.6x4.5	25	3	1,30
FG 85/25F3	0.8x5.5	25	3	1,30
FG 85/25F4	1x5.5	25	3	1,30
FG 85/25F5	1.2x6.5	25	3	1,30
FG 85/25F6	1.2x8	25	3	2,10
FG 85/25F7	1.6x8	25	3	2,10

INSERTO DA 1/4" PER VITI CON TESTA A INTAGLIO

Conforme agli standard DIN ISO 3126 - C6.3

Materiale: Cromo-Vanadio S2



CODICE	mm	L/mm	Q.tà min.	€/PZ
FG 85/50F1	0.5x3	50	3	3,20
FG 85/50F2	0.6x4.5	50	3	3,20
FG 85/50F3	0.8x5.5	50	3	3,20
FG 85/50F4	1x5.5	50	3	3,20
FG 85/50F5	1.2x6.5	50	3	3,20
FG 85/50F6	1.2x8	50	3	3,70
FG 85/50F7	1.6x8	25	3	3,70

INSERTO DA 1/4" PER VITI CON TESTA A CROCE PHILLIPS

Conforme agli standard DIN ISO 3126 - C6.3

Materiale: Cromo-Vanadio S2



CODICE	PH	L/mm	Q.tà min.	€/PZ
FG 85/25PH0	0	25	3	1,70
FG 85/25PH1	1	25	3	1,80
FG 85/25PH2	2	25	3	1,80
FG 85/25PH3	3	25	3	1,80

INSERTO DA 1/4" PER VITI CON TESTA A CROCE PHILLIPS

Conforme agli standard DIN ISO 3126 - C6.3

Materiale: Cromo-Vanadio S2



CODICE	PH	L/mm	Q.tà min.	€/PZ
FG 85/50PH1	1	50	3	3,70
FG 85/70PH1	1	70	3	5,30
FG 85/50PH2	2	50	3	3,70
FG 85/70PH2	2	70	3	5,30
FG 85/50PH3	3	50	3	3,70
FG 85/70PH3	3	70	3	5,30

INSERTO DA 1/4" PER VITI CON TESTA A CROCE POZIDRIV

Conforme agli standard DIN ISO 3126 - C6.3

Materiale: Cromo-Vanadio S2

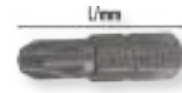

CODICE	PZ	L/mm	Q.tà min.	€/PZ
FG 85/25Z1	1	25	3	1,20
FG 85/25Z2	2	25	3	1,20
FG 85/25Z3	3	25	3	1,20
FG 85/25Z4	4	25	3	1,20

INSERTO DA 1/4" PER VITI CON TESTA A CROCE POZIDRIV

Conforme agli standard DIN ISO 3126 - C6.3

Materiale: Cromo-Vanadio S2



CODICE	PZ	L/mm	Q.tà min.	€/PZ
FG 85/50Z1	1	50	3	3,70
FG 85/50Z2	2	50	3	3,70
FG 85/50Z3	3	50	3	3,70

INSERTO DA 1/4" PER VITI CON TESTA TORX FORATA

Conforme agli standard DIN ISO 3126 - C6.3

Materiale: Cromo-Vanadio S2



CODICE	PZ	L/mm	Q.tà min.	€/PZ
FG 85/25TT10	10	25	3	2,30
FG 85/25TT15	15	25	3	2,30
FG 85/25TT20	20	25	3	2,30
FG 85/25TT25	25	25	3	2,30
FG 85/25TT27	27	25	3	2,30
FG 85/25TT30	30	25	3	2,30
FG 85/25TT40	40	25	3	2,30

INSERTO DA 1/4" PER VITI CON TESTA XZN

Conforme agli standard DIN ISO 3126 - C6.3

Materiale: Cromo-Vanadio S2



CODICE	PZ	L/mm	Q.tà min.	€/PZ
FG 85/25M4	4	25	3	1,20
FG 85/25M5	5	25	3	1,20
FG 85/25M6	6	25	3	1,20
FG 85/25M10	10	25	3	1,20



INSERTO DA 1/4" PER VITI CON TESTA ESAGONALE

Conforme agli standard DIN ISO 3126 - C6.3

Materiale: Cromo-Vanadio S2

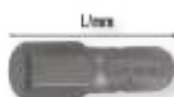

CODICE	mm	L/mm	Q.tà min.	€/PZ
FG 85/25H1.5	1.5	25	3	1,40
FG 85/25H2	2	25	3	1,40
FG 85/25H2.5	2.5	25	3	1,40
FG 85/25H3	3	25	3	1,40
FG 85/25H4	4	25	3	1,40
FG 85/25H5	5	25	3	1,40
FG 85/25H6	6	25	3	1,40
FG 85/25H7	7	25	3	1,80
FG 85/25H8	8	25	3	1,80
FG 85/25H10	10	25	3	2,30

INSERTO DA 1/4" PER VITI CON TESTA ESAGONALE

Conforme agli standard DIN ISO 3126 - C6.3

Materiale: Cromo-Vanadio S2

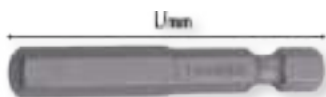

CODICE	mm	L/mm	Q.tà min.	€/PZ
FG 85/50H3	3	50	3	3,50
FG 85/50H4	4	50	3	3,50
FG 85/50H5	5	50	3	3,50
FG 85/50H6	6	50	3	3,50
FG 85/50H7	7	50	3	4,20
FG 85/50H8	8	50	3	4,20
FG 85/50H10	10	50	3	4,20

INSERTO DA 1/4" PER VITI CON TESTA TORX

Conforme agli standard DIN ISO 3126 - C6.3

Materiale: Cromo-Vanadio S2



CODICE	PZ	L/mm	Q.tà min.	€/PZ
FG 85/25T9	9	25	3	1,80
FG 85/25T10	10	25	3	1,80
FG 85/25T15	15	25	3	1,80
FG 85/25T20	20	25	3	1,80
FG 85/25T25	25	25	3	1,80
FG 85/25T27	27	25	3	1,80
FG 85/25T30	30	25	3	1,80
FG 85/25T40	40	25	3	1,80
FG 85/25T45	45	25	3	2,00
FG 85/25T50	50	25	3	2,30

INSERTO DA 1/4" PER VITI CON TESTA TORX

Conforme agli standard DIN ISO 3126 - C6.3

Materiale: Cromo-Vanadio S2

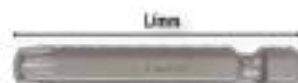

CODICE	PZ	L/mm	Q.tà min.	€/PZ
FG 85/50T9	9	50	3	4,50
FG 85/50T10	10	50	3	4,50
FG 85/50T15	15	50	3	4,50
FG 85/50T20	20	50	3	4,50
FG 85/50T25	25	50	3	4,50
FG 85/50T27	27	50	3	4,50
FG 85/50T30	30	50	3	4,50
FG 85/50T40	40	50	3	4,50
FG 85/50T45	45	50	3	5,50
FG 85/50T50	50	50	3	5,50

SET 31 INSERTI DA 1/4" + ADATTATORE PORTA INSERTI

Fornito in kit di ABS con clip di aggancio

Materiale: Cromo-Vanadio S2



CODICE	Contenuto	€/PZ
FG 85/S31	FG 88/60PI3; FG 85/25PH1, PH2, PH3; FG 85/25SL3, SL4, SL4.5, SL5, SL6, SL6.5; FG 85/25PZ1, PZ2, PZ3; FG 85/H1.5, H2, H2.5, H3, H4, H5, H6; FG 85/25T9, T10, T15, T20, T25, T27, T30, T40	68,30

SET 10 INSERTI TORX + PORTA INSERTI

Fornito in kit di ABS con clip di aggancio

Materiale: Cromo-Vanadio S2



CODICE	Contenuto	€/PZ
FG 85TX/S11	FG 85/25T7, T8, T9, T10, T15, T20, T25, T27, T30, T40	33,60

SET 10 INSERTI TORX DA 1/4" + PORTA INSERTI

Fornito in kit di ABS con clip di aggancio
Materiale: Cromo-Vanadio S2



CODICE	Contenuto	€/PZ
FG 85/S11	FG 85/25PH1, PH2, PH3; FG 85/25PZ1, PZ2, PZ3; FG 85/SL4, SL5, SL6, SL7; FG 88/60PI2	29,40

SET 98 INSERTI DA 1/4" + 2 PORTA INSERTI

Acciaio al cromo vanadio
Finitura lucida con inserto a colore
Fornito in box di ABS

NEW



CODICE	Pz	Contenuto	€/PZ
FG 85/S100	100	PH 0,1,2,3; PZ 0,1,2,3; Tri-Wing 1,2,3,4,6,8,10; XZN 5,6,8; TX 8,9,10,15,20,25,27,30,40,45; S 0,1,2,3; TX 8,10,15,20,25,27,30,35,40; SL 3,4,4,5,5,5,6,6,5,7; H 1,5,2,2,5,3,4,5,5,6,1/16, 5/64,3/32,7/64,1/8,9/64,5/32,3/16,7/32,1/4; HTR 2,2,5,3,4,5,6,5/64,3/32,7/64,1/8,9/64,5/32; SP 4,6,8,10; SP 5/32,3/16,1/4	98,00

CHIAVE MASCHIO CON IMPUGNATURA BI-MATERIALE E IMPRONTA ESAGONALE SFERICA

Asta in acciaio Cromo-Vanadio lucido
Impugnatura in Bi-materiale anti-scivolo
Impronta esagonale sferica
Consente l'utilizzo fino a 15° di inclinazione



CODICE	mm	€/PZ
FG 142/2	2	9,60
FG 142/2.5	2.5	10,20
FG 142/3	3	11,00
FG 142/4	4	12,20
FG 142/5	5	13,20
FG 142/6	6	15,00
FG 142/7	7	15,30
FG 142/8	8	16,50
FG 142/10	10	18,00

SET



SET DI 8 CHIAVI MASCHIO CON IMPUGNATURA BI-MATERIALE E IMPRONTA ESAGONALE SFERICA

Asta in acciaio Cromo-Vanadio lucido
Impugnatura in Bi-materiale anti-scivolo
Impronta esagonale sferica
Consente l'utilizzo fino a 15° di inclinazione

CODICE	Contenuto	€/PZ
FG 142/S9	2, 2.5, 3, 4, 5, 6, 7, 8, 10mm	125,00

CHIAVE MASCHIO TORX CON IMPUGNATURA BI-MATERIALE

Asta in acciaio Cromo-Vanadio lucido
Impugnatura in Bi-materiale anti-scivolo
Impronta Torx
Consente l'utilizzo fino a 15° di inclinazione



CODICE	TX	€/PZ
FG 143/TX7	7	10,20
FG 143/TX8	8	10,20
FG 143/TX9	9	10,20
FG 143/TX10	10	10,50
FG 143/TX15	15	11,00
FG 143/TX20	20	11,80
FG 143/TX25	25	12,60
FG 143/TX27	27	13,20
FG 143/TX30	30	13,90
FG 143/TX40	40	15,80
FG 143/TX45	45	18,50
FG 143/TX50	50	21,50

SET



SET DI CHIAVI MASCHIO TORX CON IMPUGNATURA BI-MATERIALE

Asta in acciaio Cromo-Vanadio lucido
Impugnatura in Bi-materiale anti-scivolo
Impronta Torx
Consente l'utilizzo fino a 15° di inclinazione

CODICE	Contenuto	€/PZ
FG 143TX/S6	TX10, TX15, TX20, TX25, TX30, TX40	80,00
FG 143TX/S12	TX7, TX8, TX9, TX10, TX15, TX20, TX25, TX27, TX30, TX40, TX45, TX50	165,00



INSERTO DA 1/4" PER VITI CON TESTA A INTAGLIO

Conforme agli standard DIN ISO 3126 - C6.3

Materiale: Cromo-Vanadio S2



CODICE	mm	L/mm	Q.tà min.	€/PZ
FG 85/100F3	0.6X3	100	3	5,30
FG 85/100F4	0.8X4	100	3	5,30
FG 85/100F5.5	1.0X5.5	100	3	5,30

INSERTO DA 1/4" PER VITI CON TESTA A CROCE POZIDRIV

Conforme agli standard DIN ISO 3126 - C6.3

Materiale: Cromo-Vanadio S2



CODICE	PZ	L/mm	Q.tà min.	€/PZ
FG 85/100PZ1	1	100	3	5,70
FG 85/100PZ2	2	100	3	5,70
FG 85/100PZ3	3	100	3	5,70

INSERTO DA 1/4" PER VITI CON TESTA A CROCE PHILLIPS

Conforme agli standard DIN ISO 3126 - C6.3

Materiale: Cromo-Vanadio S2

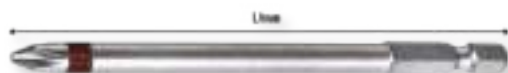

CODICE	PH	L/mm	Q.tà min.	€/PZ
FG 85/100PH1	1	100	3	5,70
FG 85/100PH2	2	100	3	5,70
FG 85/100PH3	3	100	3	5,70

INSERTO DA 1/4" PER VITI CON TESTA ESAGONALE

Conforme agli standard DIN ISO 3126 - C6.3

Materiale: Cromo-Vanadio S2



CODICE	mm	L/mm	Q.tà min.	€/PZ
FG 85/100H4	4	100	3	5,50
FG 85/100H5	5	100	3	5,50
FG 85/100H6	6	100	3	5,50

INSERTO DA 1/4" PER VITI CON TESTA TORX

Conforme agli standard DIN ISO 3126 - C6.3

Materiale: Cromo-Vanadio S2



CODICE	TX	L/mm	Q.tà min.	€/PZ
FG 85/100T15	15	100	3	5,70
FG 85/100T20	20	100	3	5,70
FG 85/100T25	25	100	3	5,70

SET 15 INSERTI DA 1/4" - LUNGHEZZA 100MM

Fornito in box di ABS con modulo interno in gomma

Materiale: Cromo-Vanadio S2

Finitura: Lucida con inserto a colore



CODICE	Contenuto	€/PZ
FG 85/S15L	15	96,60

CONTENUTO

	FG 85/100F3, F4, F5.5
	FG 85/100PH1, PH2, PH3
	FG 85/100PZ1, PZ2, PZ3
	FG 85/100H4, H5, H6
	FG 85/100T15, T20, T25

PORTA INSERTI CON MANICO BI-MATERIALE

Asta in acciaio Cromo-Vanadio lucido

Impugnatura in Bi-materiale anti-scivolo



CODICE	L/mm	€/PZ
FG 88/P14	258	25,20

PORTA INSERTI PER AVVITATORI

FG 88/60PI1 Senza anello di ritegno
FG 88/60PI2 Con anello di ritegno



CODICE	Misura	Misura	€/PZ
FG 88/60PI1	1/4"x1/4"	60	10,50
FG 88/60PI2	1/4"x1/4"	60	9,50

PORTA INSERTI PER AVVITATORI



CODICE	Misura	L/mm	€/PZ
FG 88/60PI3	1/4"x1/4"	100	13,20

PORTA INSERTI CON ATTACCO SDS PER INSERTI DA 1/4"



CODICE	L/mm	€/PZ
FG 88/100SDS	100	23,70

ADATTATORE PORTA INSERTI CON AGGANCIO QUADRO FEMMINA



CODICE	Misura	L/mm	€/PZ
FG 89/38PI1	1/4" x 1/4"	32	20,50
FG 89/50PI2	3/8" x 1/4"	50	23,70
FG 89/50PI3	3/8" x 5/16"	50	24,20
FG 89/55PI4	1/2" x 1/4"	55	27,30
FG 89/55PI5	1/2" x 5/16"	55	29,40

ADATTATORE PORTA BUSSOLE CON AGGANCIO QUADRO MASCHIO



CODICE	Misura	L/mm	€/PZ
FG 88/75PB1	1/4" x 1/4"	75	17,40
FG 88/75PB2	1/4" x 3/8"	75	20,50
FG 88/75PB3	1/4" x 1/2"	75	23,70

INSERTO PER VITI CON TESTA ESAGONALE

Conforme agli standard DIN ISO 3126 - C6.3
Materiale: Cromo-Vanadio S2



CODICE	mm	L/mm	Q.tà min.	€/PZ
FG 86/30H4	4	30	3	1,70
FG 86/30H5	5	30	3	1,70
FG 86/30H6	6	30	3	1,70
FG 86/30H7	7	30	3	1,70
FG 86/30H8	8	30	3	1,70
FG 86/30H10	10	30	3	1,70
FG 86/30H12	12	30	3	2,60
FG 86/30H14	14	30	3	3,60

INSERTO PER VITI CON TESTA ESAGONALE

Conforme agli standard DIN ISO 3126 - C6.3
Materiale: Cromo-Vanadio S2



CODICE	mm	L/mm	Q.tà min.	€/PZ
FG 86/75H4	4	75	3	3,10
FG 86/75H5	5	75	3	3,10
FG 86/75H6	6	75	3	3,10
FG 86/75H7	7	75	3	3,10
FG 86/75H8	8	75	3	3,10
FG 86/75H10	10	75	3	3,10
FG 86/75H12	12	75	3	4,20
FG 86/75H14	14	75	3	5,70

INSERTO PER VITI CON TESTA TORX

Conforme agli standard DIN ISO 3126 - C6.3
Materiale: Cromo-Vanadio S2



CODICE	TX	L/mm	Q.tà min.	€/PZ
FG 86/30T20	20	30	3	1,70
FG 86/30T25	25	30	3	1,70
FG 86/30T27	27	30	3	1,70
FG 86/30T30	30	30	3	1,70
FG 86/30T40	40	30	3	1,70
FG 86/30T45	45	30	3	1,70
FG 86/30T50	50	30	3	1,70
FG 86/30T55	55	30	3	1,70



INSERTO PER VITI CON TESTA TORX

Conforme agli standard DIN ISO 3126 - C6.3

Materiale: Cromo-Vanadio S2



CODICE	TX	L/mm	Q.tà min.	€/PZ
FG 86/75T20	20	75	3	2,80
FG 86/75T25	25	75	3	2,80
FG 86/75T27	27	75	3	2,80
FG 86/75T30	30	75	3	2,80
FG 86/75T40	40	75	3	2,80
FG 86/75T45	45	75	3	2,80
FG 86/75T50	50	75	3	2,80
FG 86/75T55	55	75	3	2,80

INSERTO PER VITI CON TESTA TORX FORATA

Conforme agli standard DIN ISO 3126 - C6.3

Materiale: Cromo-Vanadio S2

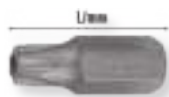

CODICE	RTX	L/mm	Q.tà min.	€/PZ
FG 86/30TT20	20	30	3	1,80
FG 86/30TT25	25	30	3	1,80
FG 86/30TT27	27	30	3	1,80
FG 86/30TT30	30	30	3	1,80
FG 86/30TT40	40	30	3	1,80
FG 86/30TT45	45	30	3	1,80
FG 86/30TT50	50	30	3	1,80
FG 86/30TT55	55	30	3	1,80

INSERTO PER VITI CON TESTA TORX FORATA

Conforme agli standard DIN ISO 3126 - C6.3

Materiale: Cromo-Vanadio S2



CODICE	RTX	L/mm	Q.tà min.	€/PZ
FG 86/75TT20	20	75	3	3,10
FG 86/75TT25	25	75	3	3,10
FG 86/75TT27	27	75	3	3,10
FG 86/75TT30	30	75	3	3,10
FG 86/75TT40	40	75	3	3,10
FG 86/75TT45	45	75	3	3,10
FG 86/75TT50	50	75	3	3,10
FG 86/75TT55	55	75	3	3,10

INSERTO PER VITI CON TESTA XZN

Conforme agli standard DIN ISO 3126 - C6.3

Materiale: Cromo-Vanadio S2



CODICE	TX	L/mm	Q.tà min.	€/PZ
FG 86/30M5	5	30	3	2,10
FG 86/30M6	6	30	3	2,10

CODICE	TX	L/mm	Q.tà min.	€/PZ
FG 86/30M8	8	30	3	2,10
FG 86/30M10	10	30	3	2,10
FG 86/30M12	12	30	3	3,00
FG 86/30M14	14	30	3	3,60

INSERTO PER VITI CON TESTA XZN

Conforme agli standard DIN ISO 3126 - C6.3

Materiale: Cromo-Vanadio S2



CODICE	TX	L/mm	Q.tà min.	€/PZ
FG 86/75M5	5	75	3	3,70
FG 86/75M6	6	75	3	3,70
FG 86/75M8	8	75	3	3,70
FG 86/75M10	10	75	3	3,80
FG 86/75M12	12	75	3	4,10

ADATTATORE PER INSERTI CON ATTACCO 10MM

CODICE	mm	€/PZ
FG 86/AD2	10	5,80

SET 28 INSERTI ATTACCO 10MM + ADATTATORI

Fornito in box di lamiera d'acciaio con modulo in gomma

Materiale: Cromo-Vanadio S2



CODICE	Contenuto	€/PZ
FG 86/S30B	28pz	89,30

CONTENUTO

- FG 86/30TT10 - T40, FG 86/75TT10 - T40
- FG 86/30TT10 - TT40, FG 86/75TT4 - TT40
- FG 86/AD2

INSERTO PER VITI CON TESTA A INTAGLIO

Material: Cromo-Vanadio S2



CODICE	mm	L/mm	Q.tà min.	€/PZ
FG 87/25F1	1.2x6.0	36	3	4,20
FG 87/25F2	1.6x8.0	36	3	4,20
FG 87/25F3	1.6x10	36	3	4,90
FG 87/25F4	2.0x12	36	3	5,40

INSERTO PER VITI CON TESTA A PHILLIPS

Material: Cromo-Vanadio S2

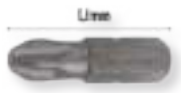

CODICE	PH	L/mm	Q.tà min.	€/PZ
FG 87/PH1	1	36	3	3,20
FG 87/PH2	2	36	3	3,20
FG 87/PH3	3	36	3	3,20
FG 87/PH4	4	36	3	3,20

INSERTO PER VITI CON TESTA A POZIDRIV

Material: Cromo-Vanadio S2



CODICE	PZ	L/mm	Q.tà min.	€/PZ
FG 87/PZ1	1	25	3	3,70
FG 87/PZ2	2	25	3	3,70
FG 87/PZ3	3	25	3	3,70

INSERTO PER VITI CON TESTA ESAGONALE

Material: Cromo-Vanadio S2



CODICE	mm	L/mm	Q.tà min.	€/PZ
FG 87/H4	4	25	3	3,20
FG 87/H5	5	25	3	3,20
FG 87/H6	6	25	3	3,20
FG 87/H8	8	25	3	3,20
FG 87/H10	10	25	3	4,20

INSERTO PER VITI CON TESTA TORX

Material: Cromo-Vanadio S2



CODICE	TX	L/mm	Q.tà min.	€/PZ
FG 87/TX20	20	36	3	4,20
FG 87/TX25	25	36	3	4,20
FG 87/TX27	27	36	3	4,20
FG 87/TX30	30	36	3	4,20
FG 87/TX40	40	36	3	4,20
FG 87/TX45	45	36	3	4,20
FG 87/TX50	50	36	3	6,30
FG 87/TX55	55	36	3	6,30

ADATTATORE PORTA INSERTI PER INSERTI CON ATTACCO 5/16"



CODICE	Attacco esagonale femmina	€/PZ
FG 87/AD	5/16" x 1/2"	6,90

GIRAVITE A PERCUSSIONE CON MANICO IN GOMMA



CODICE	L/mm	n	€/PZ
FG 23/I	145	1/2"	44,10

SET 28 UTENSILI A PERCUSSIONE

Fornito in box di ABS con modulo interno in gomma
Material: Cromo-Vanadio S2



CODICE	Contenuto	€/PZ
FG 23/S28	28pz	157,50



20+ MODELLI

DUREZZA
ACCIAIO

HRC 63

CAPACITÀ DI TAGLIO FINO A 6mm*

Il dato si riferisce al valore massimo coperto dalla gamma

FINITURA LUCIDA

SIMBOLO TIPO DI FILO - ESEMPIO



FILO METALLICO DOLCE mm - RAME, ALLUMINIO



FILO METALLICO DI MEDIA DUREZZA mm - FILO DI FERRO



FILO METALLICO DURO mm - FILO D'ACCIAIO



FILO ARMONICO mm - acciaio per molle temprato

HIGH LEVERAGE
Elevato effetto leva
per il minimo sforzo durante l'uso

SERIE INDUSTRIAL

PINZA UNIVERSALE

Conforme agli standard DIN ISO 5746
Impugnatura bi-materiale
Serie INDUSTRIAL

CODICE	mm/pollici	○	◐	◑	●	HRC	€/PZ
FG 59/XT160	160-6"	4	2.8	1.8	1.4	58-63	23,10
FG 59/XT180	180-7"	4	3	2	1.6	58-63	28,40
FG 59/XT200	200-8"	4	3	2	1.6	58-63	32,60

PINZA UNIVERSALE

Conforme agli standard DIN ISO 5746
Impugnatura bi-materiale
Effetto leva elevato
Serie INDUSTRIAL

CODICE	mm/pollici	○	◐	◑	●	HRC	€/PZ
FG 59/HL160	160-6"	4	2.8	1.8	1.4	58-63	26,80
FG 59/HL180	180-7"	4	2.8	1.8	1.6	58-63	29,90
FG 59/HL200	200-8"	5	3.5	2.4	2	58-63	35,10
FG 59/HL225	225-9"	6	4	2.8	2.4	58-63	37,10

PINZA BECCHI MEZZOTONDI CURVI

Conforme agli standard DIN ISO 5745
Impugnatura bi-materiale
Serie INDUSTRIAL

CODICE	mm/pollici	○	◐	◑	●	HRC	€/PZ
FG 60/XT160	160-6"	4	2.8	1.8	1.4	58-63	31,00
FG 60/XT200	200-8"	4	3	2	1.6	58-63	35,00

PINZA BECCHI MEZZOTONDI DRITTI

Conforme agli standard DIN ISO 5745
Impugnatura bi-materiale
Serie INDUSTRIAL

CODICE	mm/pollici	○	◐	◑	●	HRC	€/PZ
FG 61/XT160	160-6"	4	2.8	1.8	1.4	58-63	26,80
FG 61/XT200	200-8"	4	3	2	1.6	58-63	32,00

PINZA BECCHI PIATTI

Conforme agli standard DIN ISO 5745
Impugnatura bi-materiale
Serie INDUSTRIAL



CODICE	mm/pollici	€/PZ
FG 62/XT160	160 - 6"	28,90

TRONCHESE A TAGLIENTI DIAGONALI

Conforme agli standard DIN ISO 5749
Impugnatura bi-materiale
Serie INDUSTRIAL



CODICE	mm/pollici	○	◐	◑	●	HRC	€/PZ
FG 63/XT140	140-5"	3	2	1.6	1.2	58-63	29,00
FG 63/XT160	160-6"	4	2.5	2	1.6	58-63	31,00

TRONCHESE A TAGLIENTI DIAGONALI, EFFETTO LEVA ELEVATO

Conforme agli standard DIN ISO 5749
Impugnatura bi-materiale
Effetto leva elevato
Dotato di incavi spellafili 1.5 e 2.5mm
Serie INDUSTRIAL



CODICE	mm/pollici	Capacità mm ²	HRC	€/PZ
FG 63/HL180	160-6"	1.5+2.5	58-63	47,50

TRONCHESE A TAGLIENTI DIAGONALI MOD. PESANTE

Conforme agli standard DIN ISO 5749
Impugnatura bi-materiale
Serie INDUSTRIAL



CODICE	mm/pollici	○	◐	◑	●	HRC	€/PZ
FG 63/H160	160-6"	4	3	2	1.6	58-63	33,00
FG 63/H180	180-7"	5	3.5	2.4	2	58-63	35,00
FG 63/H200	200-8"	5	3.5	2.4	2	58-63	39,50

TRONCHESE A TAGLIENTI FRONTALI

Impugnatura bi-materiale
Serie INDUSTRIAL



CODICE	mm/pollici	○	◐	◑	●	HRC	€/PZ
FG 64/XT160	160-6"	4	3	2	1.6	58-63	36,00
FG 64/XT200	200-8"	5	3.5	2.4	2	58-63	43,50

PINZA A BECCHI TONDI LUNGI

Conforme agli standard DIN ISO 5749
Impugnatura bi-materiale
Serie INDUSTRIAL



CODICE	mm/pollici	€/PZ
FG 65/XT160	160-6"	28,00

SET



SET 3 PINZE ASSORTITE

Impugnatura bi-materiale
Forniti in set di cartone

CODICE	Contenuto	€/PZ
FG 59XT/S3	FG 59/XT180, FG 63/XT160, FG 61/XT160	89,50
FG 59XT/S3B	FG 63/H180, FG 61/XT200, FG 59/XT180	99,50



PINZA UNIVERSALE

Conforme agli standard DIN ISO 5746
Impugnatura bi-materiale
Serie SOFT RUN



CODICE	mm/pollici	○	◐	◑	€/PZ
FG 59SR/160	160-6"		3.1	2	21,60
FG 59SR/180	180-7"		3.4	2.2	26,30
FG 59SR/200	200-8"		3.8	2.5	30,00

PINZA A BECCHI MEZZOTONDI

Conforme agli standard DIN ISO 5745
Impugnatura bi-materiale
Serie SOFT RUN



CODICE	mm/pollici	○	◐	◑	€/PZ
FG 60SR/160	160-6"		2.5	1.6	26,80
FG 60SR/200	200-8"		3.2	2.2	32,50

PINZA A BECCHI PIATTI DRITTI

Conforme agli standard DIN ISO 5745
Impugnatura bi-materiale
Serie SOFT RUN



CODICE	mm/pollici	HRC	€/PZ
FG 62SR/160	160-6"	58	24,80

TRONCHESE A TAGLIENTI DIAGONALI

Conforme agli standard DIN ISO 5749
Impugnatura bi-materiale
Serie SOFT RUN



CODICE	mm/pollici	○	◐	◑	●	€/PZ
FG 63SR/160	160-6"		4	2.8	2	27,00

TRONCHESE A TAGLIENTI DIAGONALI MODELLO PESANTE

Conforme agli standard DIN ISO 5749
Impugnatura bi-materiale
Serie SOFT RUN



CODICE	mm/pollici	○	◐	◑	€/PZ
FG 63SR/H200	200-8"		4.2	3	34,00

PINZA SPELLAFILI

Conforme agli standard DIN ISO 8979
Impugnatura bi-materiale



CODICE	mm/pollici	max mm ²	€/PZ
FG 68SR/160	160-6"	10	31,00

TENAGLIA PER CEMENTISTI

Conforme agli standard DIN ISO 9242
Impugnatura bi-materiale



CODICE	mm/pollici	HRC	€/PZ
FG 64SR/220	220-9"	58	30,00
FG 64SR/280	280-11"	58	36,50

SET**SET 3 PINZE ASSORTITE**

Impugnatura bi-materiale
Forniti in set di cartone

CODICE	Contenuto	€/PZ
FG 59SR/S3	FG 59SR/160, FG 60SR/160, FG 63SR/H200	86,10
FG 59SR/S3B	FG 59SR/200, FG 61SR/200, FG 63SR/H200	96,60

PINZA UNIVERSALE

Conforme agli standard DIN ISO 5746
Impugnatura doppio strato in PVC

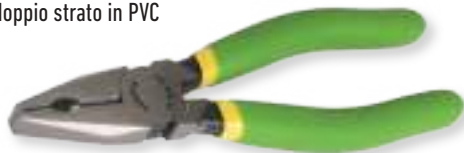

CODICE	mm/pollici	○	◐	◑	●	HRC	€/PZ
FG 59PV/160	160-6"	4	2.8	1.8	1.4	58-63	20,50
FG 59PV/180	180-7"	4	3	2	1.6	58-63	22,10
FG 59PV/200	200-8"	4	3	2	1.6	58-63	25,20

PINZA A BECCHI MEZZOTONDI CURVI

Conforme agli standard DIN ISO 5749
Impugnatura doppio strato in PVC



CODICE	mm/pollici	○	◐	◑	●	€/PZ
FG 60PV/160	160-6"		2.5	1.6		23,20
FG 60PV/200	200-8"		3.2	2.2		27,30

PINZA A BECCHI MEZZOTONDI DRITTI

Conforme agli standard DIN ISO 5745
Impugnatura doppio strato in PVC



CODICE	mm/pollici	○	◐	◑	●	HRC	€/PZ
FG 61PV/160	160-6"	3	2	1.6	1.2	58-63	22,20
FG 61PV/200	200-8"	4	2.5	2	1.6	58-63	24,30

PINZA A BECCHI PIATTI

Conforme agli standard DIN ISO 5745
Impugnatura doppio strato in PVC



CODICE	mm/pollici	€/PZ
FG 62PV/160	160-6"	22,00

TRONCHESE A TAGLIENTI DIAGONALI

Conforme agli standard DIN ISO 5749
Impugnatura doppio strato in PVC



CODICE	mm/pollici	○	◐	◑	●	HRC	€/PZ
FG 63PV/140	140-5"	4	2.8	1.8	1.4	58-63	21,00
FG 63PV/160	160-6"	4	3	2	1.6	58-63	23,00

TRONCHESE A TAGLIENTI DIAGONALI MODELLO PESANTE

Conforme agli standard DIN ISO 5749
Impugnatura doppio strato in PVC



CODICE	mm/pollici	○	◐	◑	●	HRC	€/PZ
FG 63PV/H180	180-7"	5	3.5	2.4	2	58-63	29,00
FG 63PV/H200	200-8"	5	3.5	2.4	2	58-63	30,00

TRONCHESE A TAGLIENTI FRONTALI

Conforme agli standard DIN ISO 5749
Impugnatura doppio strato in PVC



CODICE	mm/pollici	○	◐	◑	●	HRC	€/PZ
FG 64PV/160	160-6"	4	3	2	1.6	56-61	27,00
FG 64PV/200	200-8"	5	3.5	2.4	2	58-61	33,00

TENAGLIA PER CEMENTISTI

Impugnatura doppio strato in PVC



CODICE	mm/pollici	○	◐	◑	●	€/PZ
FG 65PV/220	220-9"	4	3	2	56-61	24,80
FG 65PV/250	250-10"	4	3	2	58-61	26,80
FG 65PV/280	280-11"	4	3	2	56-61	29,00

SET



SET 3 PINZE ASSORTITE

Impugnatura doppio strato in PVC
Forniti in set di cartone

CODICE	Contenuto	€/PZ
FG 59PV/S3	FG 59PV/160, FG 61PV/160, FG 63PV/160	72,00
FG 59PV/S3B	FG 59PV/180, FG 61PV/200, FG 63PV/H180	79,00



PINZA REGOLABILE A CERNIERA CHIUSA CON PULSANTE DI SGANCIO RAPIDO

Dotata di pulsante di sgancio rapido

Ganasce rinforzate con doppio trattamento di indurimento per permettere una maggiore durata nel tempo

Impugnatura in doppio strato PVC antiscivolo



CODICE	mm - pollici	Posizioni	€/PZ
FG 58/A240	240-9.5"	5	42,00

PINZA REGOLABILE A CERNIERA CHIUSA

Ganasce rinforzate con doppio trattamento di indurimento per permettere una maggiore durata nel tempo

Impugnatura in doppio strato PVC antiscivolo

Conforme agli standard DIN ISO 8976



CODICE	mm - pollici	Posizioni	€/PZ
FG 58/B180	180-7"	6	29,00
FG 58/B240	240-10"	7	33,50
FG 58/B300	300-12"	7	47,00
FG 58/400	400-16"	7	54,50

PINZA A BECCHI LUNGI ZIGRINATI PIATTI A 0°

Impugnatura doppio strato in PVC



CODICE	mm	€/PZ
FG 56/0	275	29,40
FG 57/0	400	38,00

PINZA A BECCHI LUNGI ZIGRINATI PIATTI A 45°

Impugnatura doppio strato in PVC



CODICE	mm	€/PZ
FG 56/45	275	29,40
FG 57/45	400	38,00

PINZA A BECCHI LUNGI ZIGRINATI PIATTI A 90°

Impugnatura doppio strato in PVC



CODICE	mm	€/PZ
FG 56/90	275	29,40
FG 57/90	400	38,00

SET**SET 3 PINZE A BECCHI LUNGI ZIGRINATI**

Impugnatura doppio strato in PVC

Forniti in set di cartone

CODICE	Contenuto	€/PZ
FG 56/S3	FG 56/0, FG 56/45, FG 56/90	89,30
FG 57/S3	FG 57/0, FG 57/45, FG 57/90	116,00

PINZA A BECCHI DRITTI PER ANELLI ELASTICI ESTERNI

Impugnatura doppio strato in PVC



CODICE	L/mm	Ø/mm	€/PZ
FG 51/140	140	10-25	23,10
FG 51/180	180	19-60	23,70
FG 51/230	230	40-100	33,10
FG 51/310	310	85-165	46,80

PINZA A BECCHI A 90° PER ANELLI ELASTICI ESTERNI

Impugnatura doppio strato in PVC



CODICE	L/mm	Ø/mm	€/PZ
FG 52/140	140	10-25	24,20
FG 52/180	180	19-60	26,30
FG 52/230	230	40-100	32,10
FG 52/310	310	85-165	46,80

PINZA A BECCHI DRITTI PER ANELLI ELASTICI INTERNI

Impugnatura doppio strato in PVC



CODICE	L/mm	Ø/mm	€/PZ
FG 53/140	140	12-25	23,10
FG 53/180	180	19-60	23,70
FG 53/230	230	40-100	33,10
FG 53/310	310	85-165	46,80

PINZA A BECCHI A 90° PER ANELLI ELASTICI INTERNI

Impugnatura doppio strato in PVC



CODICE	L/mm	Ø/mm	€/PZ
FG 54/140	140	12-25	24,20
FG 54/180	180	19-60	26,30
FG 54/230	230	40-100	32,10
FG 54/310	310	85-165	46,80

SET



SET 4 PINZE PER ANELLI ELASTICI

Impugnatura doppio strato in PVC
Forniti in set di cartone

CODICE	Contenuto	€/PZ
FG 51/S4	FG 51/140, FG 52/140, FG 53/140, FG 54/140	99,80
FG 51/S4B	FG 51/180, FG 52/180, FG 53/180, FG 54/180	105,00

PINZA A BECCHI DRITTI PER ANELLI ELASTICI ESTERNI CON INSERTI RINFORZATI IN ACCIAIO

Impugnatura doppio strato in PVC



CODICE	L/mm	Ø/mm	€/PZ
FG 55/140	140	10-25	33,60
FG 55/180	180	19-60	34,70

PINZA A BECCHI A 90° PER ANELLI ELASTICI ESTERNI CON INSERTI RINFORZATI IN ACCIAIO

Impugnatura doppio strato in PVC



CODICE	L/mm	Ø/mm	€/PZ
FG 56/140	140	10-25	33,60
FG 56/180	180	19-60	34,70

PINZA A BECCHI DRITTI PER ANELLI ELASTICI INTERNI CON INSERTI RINFORZATI IN ACCIAIO

Impugnatura doppio strato in PVC



CODICE	L/mm	Ø/mm	€/PZ
FG 57/140	140	10-25	33,60
FG 57/180	180	19-60	34,70

PINZA A BECCHI A 90° PER ANELLI ELASTICI INTERNI CON INSERTI RINFORZATI IN ACCIAIO

Impugnatura doppio strato in PVC



CODICE	L/mm	Ø/mm	€/PZ
FG 58/140	140	10-25	33,60
FG 58/180	180	19-60	34,70

SET 4 PINZE PER ANELLI ELASTICI CON INSERTI RINFORZATI IN ACCIAIO

Impugnatura doppio strato in PVC
Forniti in set di cartone



CODICE	Contenuto	€/PZ
FG 55/S4	FG 55/140, FG 56/140, FG 57/140, FG 58/140	136,50
FG 55/S4B	FG 55/180, FG 56/180, FG 57/180, FG 58/180	141,80



PINZA PER ANELLI ELASTICI DI SICUREZZA SP

Impugnatura doppio strato in PVC



CODICE	Capacità	€/PZ
FG 55/SP	30 - 100	47,30

PINZA TORCIFILO REVERSIBILE A RITORNO AUTOMATICO

CODICE	L/mm	€/PZ
FG 66/TF220	220	105,00

PINZA REGOLABILE AUTOBLOCCANTE CON GANASCE CONCAVE

Corpo in acciaio Cromo-Vanadio forgiato satinato



CODICE	L/mm	Apertura massima	€/PZ
FG 69/CJ180	180	31mm	24,00
FG 69/CJ250	250	37mm	26,50

PINZA REGOLABILE AUTOBLOCCANTE CON GANASCE CONCAVECorpo in acciaio Cromo-Vanadio forgiato satinato
Superior line

CODICE	L/mm	Apertura massima	€/PZ
FG 70/CJ140	140	30mm	32,50
FG 70/CJ180	180	35mm	38,00
FG 70/CJ250	250	50mm	40,00
FG 70/CJ300	300	65mm	54,00

PINZA REGOLABILE AUTOBLOCCANTE CON GANASCE DITTE

Corpo in acciaio Cromo-Vanadio forgiato satinato



CODICE	L/mm	Apertura massima	€/PZ
FG 69/LN170	170	38mm	24,50
FG 69/LN230	230	65mm	28,50

PINZA REGOLABILE AUTOBLOCCANTE CON GANASCE DITTECorpo in acciaio Cromo-Vanadio forgiato satinato
Superior line

CODICE	L/mm	Apertura massima	€/PZ
FG 70/LN165	165	40mm	39,00
FG 70/LN240	240	55mm	41,50

PINZA AUTOBLOCCANTE CON GANASCE COLLO DI CIGNO

Corpo in acciaio Cromo-Vanadio forgiato satinato



CODICE	L/mm	Apertura massima	€/PZ
FG 69/CC170	170	43mm	28,50
FG 69/CC280	280	64mm	38,00
FG 69/CC460	460	255mm	53,60

PINZA AUTOBLOCCANTE CON GANASCE COLLO DI CIGNOCorpo in acciaio Cromo-Vanadio forgiato satinato
Superior line

CODICE	L/mm	Apertura massima	€/PZ
FG 70/CC175	175	50mm	45,00
FG 70/CC280	280	90mm	60,00
FG 70/CC460	460	235mm	115,00

PINZA REGOLABILE AUTOBLOCCANTE CON GANASCE COLLO DI CIGNO OSCILLANTI

Corpo in acciaio Cromo-Vanadio forgiato satinato



CODICE	L/mm	Apertura massima	€/PZ
FG 69/CP170	170	45mm	34,50
FG 69/CP280	280	73mm	41,50

PINZA REGOLABILE AUTOBLOCCANTE CON GANASCE COLLO DI CIGNO OSCILLANTI

Corpo in acciaio Cromo-Vanadio forgiato satinato
Superior line



CODICE	L/mm	Apertura massima	€/PZ
FG 70/CP175	175	40mm	65,00
FG 70/CP280	280	90mm	70,00

PINZA REGOLABILE AUTOBLOCCANTE CON GANASCE PIATTE

Corpo in acciaio Cromo-Vanadio forgiato satinato



CODICE	L/mm	Apertura massima	€/PZ
FG 69/CS200	200	25mm	32,50

PINZA REGOLABILE AUTOBLOCCANTE CON GANASCE A FORCELLA

Corpo in acciaio Cromo-Vanadio forgiato satinato



CODICE	L/mm	Apertura massima	€/PZ
FG 69/CW225	225	25mm	34,50

PINZA REGOLABILE AUTOBLOCCANTE CON GANASCE A PAPPAGALLO

Corpo in acciaio Cromo-Vanadio forgiato satinato



CODICE	L/mm	Apertura massima	€/PZ
FG 69/PP215	215	38mm	37,80

PINZA REGOLABILE AUTOBLOCCANTE A CATENA

Corpo in acciaio Cromo-Vanadio forgiato satinato



CODICE	L/mm	Ø/mm	€/PZ
FG 69/CH130	250	75mm	43,00

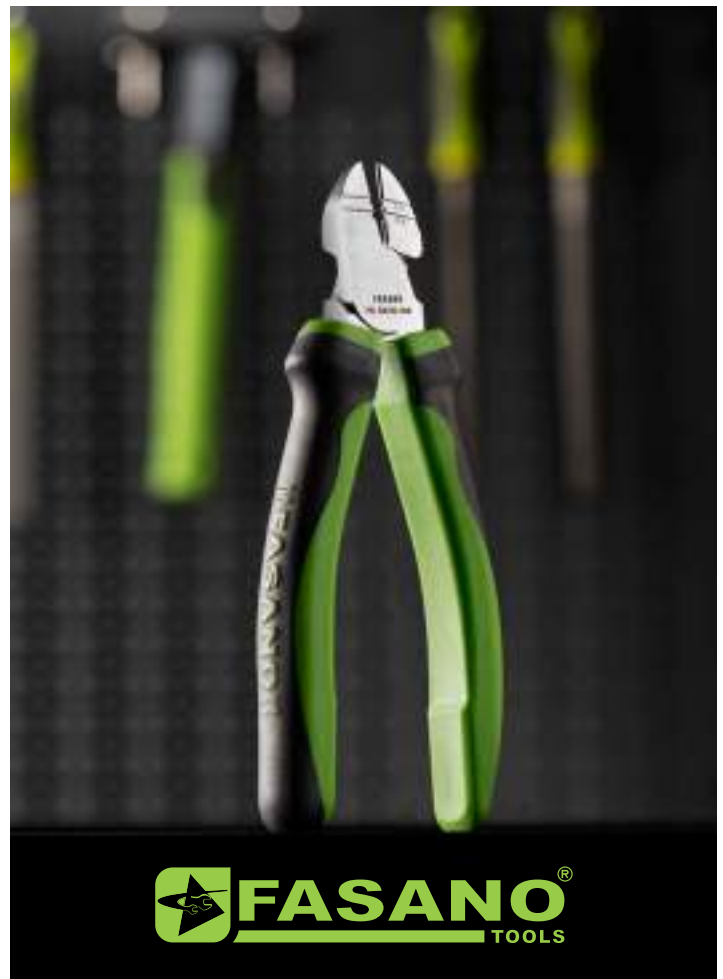



04

UTENSILI ISOLATI



CHIAVE A FORCHETTA SEMPLICE

Conforme alla normativa 1000V IEC 60900



CODICE	mm	L/mm	€/PZ
FG 603/E7	7	90	22,70
FG 603/E8	8	105	22,70
FG 603/E9	9	105	23,70
FG 603/E10	10	105	24,80
FG 603/E11	11	125	25,80
FG 603/E12	12	125	25,80
FG 603/E13	13	155	27,90
FG 603/E14	14	155	27,90
FG 603/E16	16	170	30,90
FG 603/E17	17	170	33,00
FG 603/E18	18	180	34,00
FG 603/E19	19	180	35,00

SET**SET CHIAVI A FORCHETTA SEMPLICI**

Conforme alla normativa 1000V IEC 60900

CODICE	Contenuto	€/PZ
FG 603/SP6	8, 10, 13, 14, 17, 19mm	175,00
FG 603/SP9	8, 10, 11, 12, 13, 14, 16, 17, 19mm	257,50
FG 603/SP11	8, 9, 10, 11, 12, 13, 14, 16, 17, 18, 19mm	309,00

**SET 12 CHIAVI A FORCHETTA SEMPLICI**

Conforme alla normativa 1000V IEC 60900

CODICE	Contenuto	€/PZ
FG 603/SC12	7, 8, 9, 10, 11, 12, 13, 14, 16, 17, 18, 19mm	335,00

CHIAVE REGOLABILE A RULLINO

Conforme alla normativa 1000V IEC 60900



CODICE	L/mm	€/PZ
FG 35/E250	250	98,00

CRICCHETTO REVERSIBILE A 1/2"

Conforme alla normativa 1000V IEC 60900



CODICE	L/mm	€/PZ
FG 625E/CR12	255	160,00

QUADRO MASCHIO A T CON ATTACCO QUADRO 1/2"

Conforme alla normativa 1000V IEC 60900



CODICE	L/mm	€/PZ
FG 625E/T12	205	93,00

PROLUNGA CON ATTACCO QUADRO 1/2"

Conforme alla normativa 1000V IEC 60900



CODICE	L/mm	€/PZ
FG 625E/PR125	125	62,00
FG 625E/PR250	250	77,00

INSERTO A BUSSOLA ESAGONALE DA 1/2"

Conforme alla normativa 1000V IEC 60900



CODICE	mm	L/mm	€/PZ
FG 150E/H4	4	76	26,80
FG 150E/H5	5	76	26,80
FG 150E/H6	6	76	26,80
FG 150E/H8	8	76	26,80
FG 150E/H10	10	76	27,90

INSERTO A BUSSOLA ESAGONALE DA 1/2" - MODELLO LUNGO

Conforme alla normativa 1000V IEC 60900



CODICE	mm	L/mm	€/PZ
FG 150E/LH4	4	118	32,50
FG 150E/LH5	5	118	32,50
FG 150E/LH6	6	118	32,50
FG 150E/LH8	8	118	32,50
FG 150E/LH10	10	118	35,00

CHIAVE A BUSSOLA ESAGONALE CON ATTACCO QUADRO 1/2"

Conforme alla normativa 1000V IEC 60900



CODICE	mm	L/mm	€/PZ
FG 625E/10	10	55	21,70
FG 625E/11	11	55	21,70
FG 625E/12	12	55	21,70
FG 625E/13	13	55	21,70
FG 625E/14	14	55	21,70
FG 625E/17	17	55	22,70
FG 625E/19	19	55	24,50
FG 625E/22	22	55	28,50
FG 625E/24	24	55	29,50
FG 625E/27	27	55	36,00
FG 625E/32	32	55	44,50

SET 20 UTENSILI ISOLATI DA 1/2"

Conforme alla normativa 1000V IEC 60900



CODICE	Contenuto	€/PZ
FG 625E/S20	20pz	845,00

CONTENUTO

	FG 625E	10, 11, 13, 14, 17, 19, 22, 24, 27, 32
	FG 150E/H	4, 5, 6, 8, 10
	FG 625E/CR12	
	FG 625E/T12	
	FG 625E/PR125 FG 625E/PR250	

SET 12 UTENSILI ISOLATI DA 1/2"

Conforme alla normativa 1000V IEC 60900



CODICE	Contenuto	€/PZ
FG 625E/S12	12pz	570,00

CONTENUTO

	FG 625E	10, 11, 12, 13, 14, 17, 19, 22, 24
	FG 625E/CR12	
	FG 625E/PR125 FG 625E/PR250	



SET



SET 5 CHIAVI A BUSSOLA ISOLATE

Conforme alla normativa 1000V IEC 60900

CODICE	Contenuto	€/PZ
FG 625E/S5	10, 13, 14, 17, 19mm	130,00



SET 4 INSERTI A BUSSOLA

Conforme alla normativa 1000V IEC 60900

CODICE	Contenuto	€/PZ
FG 150E/S4	4, 5, 6, 8mm	118,50

CRICCHETTO REVERSIBILE DA 3/8"

Conforme alla normativa 1000V IEC 60900



CODICE	L/mm	€/PZ
FG 624E/CR38	195	149,00

CHIAVE A BUSSOLA ESAGONALE CON ATTACCO QUADRO 3/8"

Conforme alla normativa 1000V IEC 60900



CODICE	mm	L/mm	€/PZ
FG 624E/8	8	49	16,50
FG 624E/10	10	49	16,50
FG 624E/12	12	49	17,00
FG 624E/13	13	49	17,50
FG 624E/14	14	49	18,50
FG 624E/17	17	49	20,50
FG 624E/19	19	49	22,50
FG 624E/22	22	49	24,50

INSERTO A BUSSOLA ESAGONALE ATTACCO QUADRO 3/8"

Conforme alla normativa 1000V IEC 60900



CODICE	mm	L/mm	€/PZ
FG 149E/H4	4	65	18,60
FG 149E/H5	5	65	18,80
FG 149E/H6	6	65	19,00
FG 149E/H8	8	65	22,20

QUADRO MASCHIO A T DA 3/8"

Conforme alla normativa 1000V IEC 60900



Dotato di sistema di aggancio/sgancio rapido

CODICE	L/mm	€/PZ
FG 624E/T38	205	87,00

PROLUNGA DA 3/8"

Conforme alla normativa 1000V IEC 60900



3/8"

Dotato di sistema di aggancio/sgancio rapido

CODICE	L/mm	€/PZ
FG 624E/PR150	150	58,00
FG 624E/PR250	250	72,00

SET 16 UTENSILI ISOLATI DA 3/8"

Conforme alla normativa 1000V IEC 60900



3/8"

CODICE	Contenuto	€/PZ
FG 624E/S16	16pz	670,00

CONTENUTO

	FG 624E	8, 10, 12, 13, 14, 17, 19, 22
	FG 149E/H	4, 5, 6, 8
	FG 624E/CR38	
	FG 624E/T38	
	FG 624E/PR150 FG 624E/PR250	

SET 10 UTENSILI ISOLATI DA 3/8"

Conforme alla normativa 1000V IEC 60900



3/8"

CODICE	Contenuto	€/PZ
FG 624E/S10	10pz	465,00

CONTENUTO

	FG 624E	8, 10, 12, 13, 14, 17, 19
	FG 624E/CR38	
	FG 624E/PR150 FG 624E/PR250	

SET



SET 6 CHIAVI A BUSSOLA ISOLATE DA 3/8"

Conforme alla normativa 1000V IEC 60900

CODICE	Contenuto	€/PZ
FG 624E/S6	8,10,12,13,17,19	130,00



SET 4 INSERTI A BUSSOLA ISOLATI DA 3/8"

Conforme alla normativa 1000V IEC 60900

CODICE	Contenuto	€/PZ
FG 149E/S4	4,5,6,8	92,00



GIRAVITE ISOLATO PER VITI CON TESTA A INTAGLIO

Conforme alla normativa 1000V IEC 60900



CODICE	AxB mm	L1 mm	Ø2xL2 mm	L/mm	Q.tà min.	€/PZ
FG 22E/2.5x75	2.5x0.4	75	28.9x101	176	5	8,30
FG 22E/3x100	3.0x0.5	100	28.9x101	201	5	8,50
FG 22E/4x100	4.0x0.8	100	32.0x114	214	5	9,30
FG 22E/5.5x125	5.5x1.0	125	32.0x114	239	5	10,90
FG 22E/6.5x150	6.5x1.2	150	36.0x125	275	2	11,40
FG 22E/8x175	8.0x1.2	175	36.0x125	300	2	12,40

GIRAVITE ISOLATO PER VITI CON TESTA A CROCE PHILLIPS

Conforme alla normativa 1000V IEC 60900



CODICE	PH mm	Ø1xL1 mm	Ø2xL2 mm	L/mm	Q.tà min.	€/PZ
FG 22E/PH0x60	0	3.0x60	28.9x100.9	161	3	8,30
FG 22E/PH1x80	1	4.5x80	32.0x114	194	3	9,30
FG 22E/PH2x100	2	6.0x100	36.0x125	225	2	10,30
FG 22E/PH3x150	3	8.0x150	39.4x136	286	2	11,40

GIRAVITE ISOLATO PER VITI CON TESTA A CROCE POZIDRIV

Conforme alla normativa 1000V IEC 60900

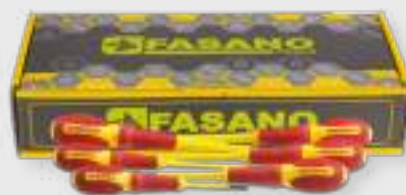

CODICE	PZ mm	Ø1xL1 mm	Ø2xL2 mm	L/mm	Q.tà min.	€/PZ
FG 22E/PZ0x60	0	3.0x60	28.9x100.9	161	3	8,30
FG 22E/PZ1x80	1	4.5x80	32.0x114	194	3	9,10
FG 22E/PZ2x100	2	6.0x100	36.0x125	225	2	9,80
FG 22E/PZ3x150	3	8.0x150	39.4x136	286	2	11,40

SET**SET 6 GIRAVITI ISOLATI PER VITI CON TESTA A INTAGLIO**

Conforme alla normativa 1000V IEC 60900

CODICE	Contenuto	€/PZ
FG 22E/SL6	2.5x75, 3x100, 4x100, 5.5x125, 6.5x150, 8x175	63,90

**SET 4 GIRAVITI ISOLATI CON TESTA A CROCE PHILLIPS**

Conforme alla normativa 1000V IEC 60900

CODICE	Contenuto	€/PZ
FG 22E/SH4	PH0x60, PH1x80, PH2x100, PH3x150	47,40

**SET 4 GIRAVITI ISOLATI CON TESTA A CROCE POZIDRIV**

Conforme alla normativa 1000V IEC 60900

CODICE	Contenuto	€/PZ
FG 22E/SZ4	PZ0x60, PZ1x80, PZ2x100, PZ3x150	47,40

**SET 6 GIRAVITI ISOLATI**

Conforme alla normativa 1000V IEC 60900

CODICE	Contenuto	€/PZ
FG 22E/S6	3X100, 4X100, 5.5X125, PH0x60, PH1x80, PH2x100	58,00



SET 6 GIRAVITI ISOLATI

Conforme alla normativa 1000V IEC 60900

CODICE	Contenuto	€/PZ
FG 22E/SZ6	3X100, 4X100, 5.5X125, PZ0x60, PZ1x80, PZ2x100	58,00

GIRAVITE PROVA CIRCUITO 6-24V



CODICE	L/mm	€/PZ
FG 22/CF24	125	9,50

GIRAVITE CERCAFASE 110/250V

Conforme agli standard DIN ISO 0680



CODICE	L/mm	€/PZ
FG 22/CF250	190	7,90

SPELLACAVI SEMPLICE



CODICE	Ø/mm	L/mm	€/PZ
FG 68/CS1	4 - 28	105	16,50

LAMA DI RICAMBIO



CODICE	€/PZ
FG 68/CS1-R	6,30

SPELLACAVI CON LAMA A COLTELLO



CODICE	Ø/mm	L/mm	€/PZ
FG 68/CS2	8 - 28	175	18,50

LAMA DI RICAMBIO



CODICE	€/PZ
FG 68/CS2-R	6,30

SPELLACAVI ELICOIDALE



CODICE	Ø/mm	L/mm	€/PZ
FG 68/CS6	8 - 28	140	26,50

LAMA DI RICAMBIO



CODICE	€/PZ
FG 68/CS6-R	8,30

SPELLACAVI MULTIFUNZIONE



CODICE	L/mm	Capacità mm ²	AWG	€/PZ
FG 68/SP1	140	0.5-6	20-10 RG59 - RG6	22,00



PINZA TAGLIA SPELLAFILI PER CAPICORDA ISOLATI

CODICE	Ø/mm ²	AWG	L/mm	€/PZ
FG 68/S1	0.75-6	10-24	215	14,00

PINZA TAGLIA E SPELLAFILI PER CAPICORDA ISOLATI

CODICE	Ø/mm ²	AWG	L/mm	€/PZ
FG 68/SP	0.2-6	8-24	205	35,00

SPELLAFILI FRONTALE, DOTATA DI INCAVO SPELLAFILI

CODICE	Ø/mm ²	AWG	L/mm	€/PZ
FG 68/SP2	0.2-6	27-17	175	15,00

PINZA UNIVERSALE CON MANICI ISOLATI

Conforme alla normativa 1000V IEC 60900
Conforme agli standard DIN ISO 5746



CODICE	mm/pollici	€/PZ
FG 59/IS180	180-7"	38,70
FG 59/IS200	200-8"	41,20

PINZA A BECCHI MEZZOTONDI CON MANICI ISOLATI

Conforme alla normativa 1000V IEC 60900
Conforme agli standard DIN ISO 5745



CODICE	mm/pollici	€/PZ
FG 61/IS200	200-8"	40,00

TRONCHESE A TAGLIENTI DIAGONALI CON MANICI ISOLATI

Conforme alla normativa 1000V IEC 60900
Conforme agli standard DIN ISO 5745



CODICE	mm/pollici	€/PZ
FG 63/IS160	160-6"	39,70

TRONCHESE A TAGLIENTI DIAGONALI MODELLO PESANTE

Conforme alla normativa 1000V IEC 60900
Conforme agli standard DIN ISO 5749



CODICE	mm/pollici	€/PZ
FG 63/HIS180	180-7"	43,30
FG 63/HIS200	200-8"	44,30

PINZA SPELLAFILI CON MANICI ISOLATI

Conforme alla normativa 1000V IEC 60900
Conforme agli standard DIN ISO 8979



CODICE	mm/pollici	€/PZ
FG 68IS/160	160-6"	39,20

PINZA REGOLABILE A CERNIERA CHIUSA CON MANICI ISOLATI

Conforme alla normativa 1000V IEC 60900
Conforme agli standard DIN ISO 8976



CODICE	mm/pollici	€/PZ
FG 58/IS250	250-9.5"	55,70

SET



SET 3 PINZE ASSORTITE CON MANICI ISOLATI

Conforme alla normativa 1000V IEC 60900

CODICE	Contenuto	€/PZ
FG 59IS/S3	FG 59/IS180, FG 61/IS200, FG 63/IS160	118,50

FORBICI DA ELETTRICISTA DOTATE DI INCAVO SPELLAFILI

Conforme alla normativa 1000V IEC 60900



CODICE	L/mm	€/PZ
FG 49/E	155	41,50

TAGLIACAVI PER CAVI IN RAME E ALLUMINIO



CODICE	L/mm	Ø/mm	€/PZ
FG 68/TC230	230	17	83,00

CUTTER ISOLATO CON SISTEMA DI BLOCCAGGIO LAMA

Conforme alla normativa 1000V IEC 60900



CODICE	L/mm	€/PZ
FG 48/IS	185	24,80

TAGLIACAVI PER CAVI IN RAME NON ISOLATO



CODICE	L/mm	Capacità mm ² - Ø/mm	€/PZ
FG 68/CC	600	255 - 32	175,00

TAGLIACAVI A CRICCHETTO NON ISOLATO



CODICE	L/mm	Capacità mm ² - Ø/mm	€/PZ
FG 68/CR	255	325 - 36	212,00



SET 26 UTENSILI ISOLATI

Conforme alla normativa 1000V IEC 60900



CE

CODICE	Contenuto	€/PZ
FG 603/S26	26pz	875,00

CONTENUTO

	FG59/IS200	
	FG61/IS200	
	FG63/IS160	
	FG603/E	10,11,12,13,14,17,19
	FG625E	10,11,12,13,14,17,19
	FG22/E	4x100,5.5x125
	FG22E/PH	1x80,2x100
	FG625E/CR12	
	FG625E/PR250	
	FG49/E	
	FG48/IS	
	FG22/CF250	



ELMETTO DIELETTRICO 1.000V



CODICE	€/PZ
FG 603/EL	55,00

ELMETTO DIELETTRICO 1.000V COMPLETO DI VISIERA



CODICE	€/PZ
FG 603/EL1	154,50

GUANTI DIELETRICI 1.000V



CODICE	Taglia	€/PZ
FG 603/GU9	9	118,50
FG 603/GU10	10	118,50

TAPPETO ISOLANTE



CODICE	Misure mm	€/PZ
FG 603/TA1	1.000 x 1.000 x 3	278,00

MULTIMETRO DIGITALE DC/AC - OHM

Classe II
 Categoria sovratensione: CAT III 300V
 Test di continuità
 Frequenza: 10Hz-200kHz
 Prova diodi
 Duty cycle 5%-95% RH (± 0.1%)
 Temperatura -20°C/400°C (± 1.5% ± 3.0°C) / 400°C/1000°C (± 2.0% ± 3.0°C)
 Misurazione Lux 4.000 Lux (± 1) / 40.000 Lux (± 10)
 Capacità rilevazione umidità 30%-90% RH (± 0.1%)
 Capacità di rilevazione suono 35 - 100dB (± 0.1dB)
 Stand by dopo 15 minuti
 Indicatore di livello batteria
 Batteria da 9 V



CODICE	DC	AC	Ω	LxPxH/mm	€/PZ
FG 96/DG	400mV-300V	4V-300V	400Ω-40MΩ	165x80x35	185,00

MULTIMETRO DIGITALE DC/AC - OHM

Classe II
 Categoria sovratensione: CAT III 600V
 Prova diodi
 Alimentazione: 1 batteria tipo AAA da 1.5V



CODICE	DC	AC	Ω	LxPxH/mm	€/PZ
FG 97/DG	600mV-600V	6V-600V	600Ω-60MΩ	148x76x21	135,00

MULTIMETRO DIGITALE DC/AC - OHM

Classe II
 Categoria sovratensione: CAT IV 600V; CAT III 1000V
 Frequenza: 100 kHz
 Prova diodi
 Alimentazione: 1 batteria da 9V

NEW



CODICE	DC	AC	Ω	LxPxH/mm	€/PZ
FG 98/DG	200mV-1000V	2V-750V	200Ω-20MΩ	184x90x46	340,00

PINZA AMPEROMETRICA DIGITALE

Classe II
 Categoria sovratensione: CAT III 600V
 Temperatura: -20°C ÷ 1000°C (-4°F ÷ 1832°F)
 Frequenza: 10Hz; 100Hz; 1000Hz; 10kHz; 100kHz; 1000kHz;
 10MHz Prova diodi
 Alimentazione: 3 batterie da 1.5V TIPO AAA

NEW



CODICE	DC	AC	Ω	LxPxH/mm	€/PZ
FG 99/DG	600mV-600V	6V-600V	600Ω-60MΩ	194x59x29	250,00



PINZA PER CAPICORDA TUBETTO



CODICE	Ø/mm ²	AWG	€/PZ
FG 68/AT6	0.5-4	20-10	67,00
FG 68/AT16	6-16	10-5	67,00

PINZA PER CAPICORDA PREISOLATI



CODICE	Ø/mm ²	AWG	€/PZ
FG 68/AG	0.5-6	10-22	67,00

PINZA PER CAPICORDA NON ISOLATI



CODICE	Ø/mm ²	AWG	€/PZ
FG 68/NI	0.5-2.5	20-13	75,00

PINZA PER CONNETTORI BNC PER CAVI COASSIALI RG58, RG62, RG71



CODICE	Cavi coassiali	€/PZ
FG 68/BNC	RG58, RG62, RG71	97,00

PINZA PER CONNETTORI RJ4, RJ6 ED RJ8



CODICE	Ø/mm ² - AWG	€/PZ
FG 68/RJ	RJ10, RJ11/12, RJ45	75,00

PINZA UNIVERSALE A MATRICE INTERCAMBIABILE



CODICE	L/mm	€/PZ
FG 68/UN	220	88,00

MATRICI INTERCAMBIABILI PER PINZA FG 68/UN



CODICE	Uso	€/PZ
FG 68/MAT4	Capicorda a tubetto	43,50
FG 68/MAT16	Capicorda a tubetto	43,50
FG 68/MAG	Capicorda preisolati	43,50
FG 68/MAN	Capicorda non isolati	43,50
FG 68/MAS	Terminali non isolati	43,50

SET



SET PINZA UNIVERSALE + 3 MATRICI (FG 68/MAT4, MAT16, MAG) CON ASSORTIMENTO 435 CAPICORDA ISOLATI

CODICE	Contenuto	€/PZ
FG 68U/S439	439pz	298,00

MICROGIRAVITE PER VITI CON IMPRONTA A INTAGLIO



CODICE	mm	L/mm	Q.tà min.	€/PZ
FG 84/F1	0.2X1.2	130	3	4,60
FG 84/F2	0.2X1.5	130	3	4,60
FG 84/F3	0.4X2.0	130	3	4,60
FG 84/F4	0.4X2.5	140	3	4,60
FG 84/F5	0.5X3.0	150	3	4,60
FG 84/F7	0.8X4.0	150	3	4,60

MICROGIRAVITE PER VITI CON IMPRONTA PHILLIPS



CODICE	PH	L/mm	Q.tà min.	€/PZ
FG 84/PH00	00	130	3	4,60
FG 84/PH0	0	130	3	4,60
FG 84/PH1	1	140	3	4,60

MICROGIRAVITE CON IMPRONTA ESAGONALE



CODICE	mm	L/mm	Q.tà min.	€/PZ
FG 84/H1.5	1.5	140	3	5,40
FG 84/H2	2.0	140	3	5,40
FG 84/H2.5	2.5	150	3	5,40
FG 84/H3	3.0	150	3	5,40

MICROGIRAVITE CON IMPRONTA TORX



CODICE	TX	L/mm	Q.tà min.	€/PZ
FG 84/TX3	3	130	3	5,30
FG 84/TX4	4	130	3	5,30
FG 84/TX5	5	130	3	5,30
FG 84/TX6	6	130	3	5,30
FG 84/TX7	7	130	3	5,30
FG 84/TX8	8	140	3	5,30
FG 84/TX9	9	150	3	5,30
FG 84/TX10	10	150	3	5,30
FG 84/TX15	15	150	3	5,30
FG 84/TX20	20	150	3	5,30

SET



SET 6 MICROGIRAVITI

Forniti in box di cartone

CODICE	Contenuto	€/PZ
FG 84F/S6	1.2, 1.5, 2.0, 2.5, 3.0, 4.0	29,90
FG 84F/S6B	1.2, 1.5, 2.0, 2.5, 3.0, 4.0	29,90

SET



SET 6 MICROGIRAVITI

Forniti in box di cartone

CODICE	Contenuto	€/PZ
FG 84PH/S6	1.5, 2.0, 3.0, 4.0 PH00, PH0	29,90
FG 84PH/S6B	2.0, 2.5, 3.0, 4.0 PH0, PH1	29,90

SET



SET 6 MICROGIRAVITI

Forniti in box di cartone

CODICE	Contenuto	€/PZ
FG 84TX/S6	TX07, TX08, TX09, TX10, TX15, TX20	33,00

PINZETTA DI PRECISIONE CON PUNTE ARROTONDATE

Acciaio inossidabile
Antimagnetica
Antiacido



CODICE	L/mm	€/PZ
FG 85/TW1	115	12,70

PINZETTA DI PRECISIONE CON PUNTE FINISSIME

Acciaio inossidabile
Antimagnetica
Antiacido



CODICE	L/mm	€/PZ
FG 85/TW2	120	12,70

PINZETTA DI PRECISIONE CON PUNTE FORTI DRITTE

Acciaio inossidabile
Antimagnetica
Antiacido



CODICE	L/mm	€/PZ
FG 85/TW3	120	12,70

PINZETTA DI PRECISIONE CON PUNTE FINISSIME DRITTE

Acciaio inossidabile
Antimagnetica
Antiacido



CODICE	L/mm	€/PZ
FG 85/TW4	110	12,70

PINZETTA DI PRECISIONE CON PUNTE FINISSIME CURVE

Acciaio inossidabile
Antimagnetica
Antiacido



CODICE	L/mm	€/PZ
FG 85/TW5	120	12,70





MICROPINZE

DEDICATO AL MONDO DELL'ELETTRONICA, UN RANGE DI 22 MODELLI PER SODDISFARE OGNI SPECIFICA ESIGENZA DEL LAVORO QUOTIDIANO.

- DESIGN ERGONOMICO
- BECCHI PRODOTTI CON I MIGLIORI ACCIAI, PER GARANTIRE IL MASSIMO DELL' AFFIDABILITÀ!



BECCHI PIATTI

MICROPINZA A BECCHI PIATTI LUNGI LISCI



L1/mm: 40 - A/mm: 12 - B/mm: 8



CODICE	L/mm	€/PZ
FG 80/BL140	140	32,00

MICROPINZA A BECCHI PIATTI LUNGI PIEGATI LISCI



L1/mm: 38 - A/mm: 12 - B/mm: 13



CODICE	L/mm	€/PZ
FG 80/BLP140	140	32,00

MICROPINZA A BECCHI PIATTI CORTI LISCI



L1/mm: 18 - A/mm: 12 - B/mm: 8



CODICE	L/mm	€/PZ
FG 80/BP125	125	32,00

BECCHI TONDI

MICROPINZA A BECCHI TONDI CORTI



L1/mm: 40 - A/mm: 12 - B/mm: 8



CODICE	L/mm	€/PZ
FG 81/BT125	125	32,00

BECCHI MEZZOTONDI

MICROPINZA A BECCHI MEZZOTONDI LUNGI LISCI



L1/mm: 40 - A/mm: 12 - B/mm: 8



CODICE	L/mm	€/PZ
FG 81/BML140	140	32,00

MICROPINZA A BECCHI MEZZOTONDI CORTI LISCI



L1/mm: 29 - A/mm: 12 - B/mm: 8



CODICE	L/mm	€/PZ
FG 81/BMC140	140	32,00

MICROPINZA A BECCHI MEZZOTONDI LUNGI ZIGRINATI

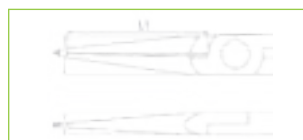

L1/mm: 39 - A/mm: 12 - B/mm: 8



CODICE	L/mm	€/PZ
FG 81/BMZ140	140	32,00

BECCHI MEZZOTONDI AFFUSOLATI

MICROPINZA A BECCHI MEZZOTONDI LUNGI LISCI E AFFUSOLATI

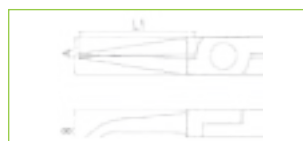

L1/mm: 37 - A/mm: 12 - B/mm: 8



CODICE	L/mm	€/PZ
FG 81/BMR140	140	32,00

MICROPINZA A BECCHI MEZZOTONDI LUNGI LISCI, AFFUSOLATI E PIEGATI



L1/mm: 36,5 - A/mm: 12 - B/mm: 12



CODICE	L/mm	€/PZ
FG 81/BMP140	125	32,00

TAGLIENTI SEMIRASI

MICROTRONCHESE A TAGLIENTI DIAGONALI SEMIRASI E BECCHI SOTTILI

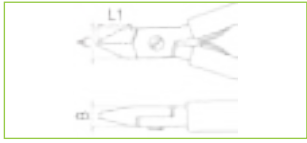

L1/mm: 11 - A/mm: 10 - B/mm: 1

CODICE	L/mm	€/PZ
FG 82/TDS120	120	32,00

MICROTRONCHESE A TAGLIENTI DIAGONALI SEMIRASI E BECCHI ARROTONDATI

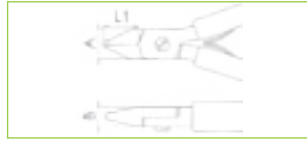

L1/mm: 11 - A/mm: 10 - Taglio: 1

CODICE	L/mm	€/PZ
FG 82/DSA120	120	32,00

TAGLIENTI RASI

MICROTRONCHESE A TAGLIENTI DIAGONALI RASI E BECCHI SOTTILI

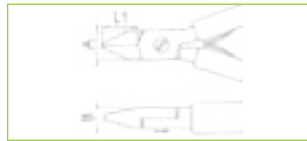

CODICE	L/mm	L1/mm	A/mm	Taglio	€/PZ
FG 82/DRS120	120	11	10	1	32,00
FG 82/DRS130	130	13	12.5	1.25	36,00

MICROTRONCHESE A TAGLIENTI DIAGONALI RASI E BECCHI ARROTONDATI

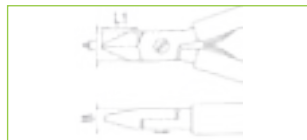

CODICE	L/mm	L1/mm	A/mm	Taglio	€/PZ
FG 82/DRA120	120	11	10	1	32,00
FG 82/DRA130	130	13	12.5	1.25	35,00

MICROTRONCHESE A TAGLIENTI DIAGONALI RASI E BECCHI SOTTILI SCARICATI



CODICE	L/mm	L1/mm	A/mm	Taglio	€/PZ
FG 82/RAS120	120	11	10	1	32,00
FG 82/RAS130	130	13	12.5	1.25	36,00

TAGLIENTI FRONTALI

MICROTRONCHESE A TAGLIENTI FRONTALI

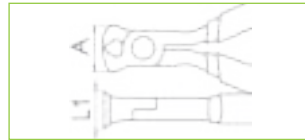

L1/mm: 12 - A/mm: 12 - Taglio: 1.25

CODICE	L/mm	€/PZ
FG 83/TF120	120	32,00

TAGLIENTI OBLIQUI

MICROTRONCHESE A TAGLIENTI DIAGONALI RASI E BECCHI SOTTILI

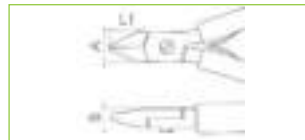

L1/mm: 17 - A/mm: 5 - Taglio: 2

CODICE	L/mm	€/PZ
FG 83/TD130	130	36,10

TAGLIENTI OBLIQUI RASI

MICROTRONCHESE A TAGLIENTI OBLIQUI RASI E BECCHI LUNGI SOTTILI



L1/mm: 8 - A/mm: 12 - Taglio: 0.8

CODICE	L/mm	€/PZ
FG 84/TOR130	130	36,00

MICROTRONCHESE A TAGLIENTI OBLIQUI RASI DOTATA DI SPELLAFILE

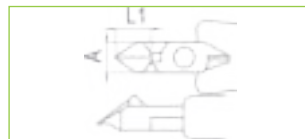

L1/mm: 18 - A/mm: 12 - Taglio: 1

CODICE	L/mm	€/PZ
FG 84/ORS130	130	36,00





SPORT 4 SUV

FASANO

—
05
—

UTENSILI DINAMOMETRICI



CHIAVE DINAMOMETRICA A DISINNESTO E AGGANCIO 1/4"Precisione $\pm 4\%$

Risoluzione: 0.1 Nm

Destrorsa e Sinistrorsa



CODICE	■	L/mm	D/mm	Nm	€/PZ
FG 531	1/4"	262	26	5-25	215,00

CHIAVE DINAMOMETRICA A DISINNESTO E AGGANCIO 3/8"Precisione $\pm 4\%$

Risoluzione: 0.25 Nm

Destrorsa e Sinistrorsa

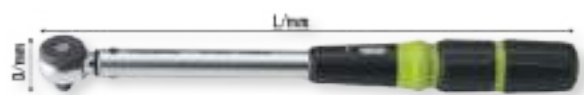

CODICE	■	L/mm	D/mm	Nm	€/PZ
FG 533/2	3/8"	405	38.5	10-50	240,00

CHIAVE DINAMOMETRICA A DISINNESTO E AGGANCIO 1/2"Precisione $\pm 4\%$

Destrorsa e Sinistrorsa



CODICE	■	L/mm	D/mm	Nm	Risoluzione	€/PZ
FG 536/1	1/2"	405.0	38.5	20-100	0.5Nm	240,00
FG 536/2	1/2"	505.0	38.5	40-200	1.0Nm	250,00
FG 536/3	1/2"	565.0	40.0	60-340	2.0Nm	265,00

CHIAVE DINAMOMETRICA A DISINNESTO E AGGANCIO A INSERTO 1/4"

CODICE	■	L/mm	D/mm	Nm	%	€/PZ
FG 528	1/4"	230	30	1-5	± 6	415,00

UTENSILE PER SERRAGGIO ANGOLARE CON SISTEMA MAGNETICO

CODICE	□	Ø/mm	L/mm	€/PZ
FG 560/A	1/2"	63	410	72,00
FG 561	3/4"	83	610	155,00

UTENSILE PER SERRAGGIO ANGOLARE

CODICE	□	€/PZ
FG 562	1/2"	60,00

CHIAVE DINAMOMETRICA DIGITALE PER NM E GRADI - 1/2"Precisione di serraggio $\pm 4\%$

Destrorsa e Sinistrorsa

Doppia manualità di misurazione: PICCO e TRACCIA

Indicatore sonoro e visivo a 12 led al raggiungimento della coppia prefissata
Possibilità di memorizzare fino a 250 differenti serraggi grazie al software PC
incluso nel kit

Interfaccia PC tramite presa USB

Possibilità di impostare fino a 9 serraggi pre-definiti

Alimentazione: 2 batterie 1.5V



CODICE	■	L/mm	D/mm	Nm	Gradi	€/PZ
FG 543/DG1	1/2"	396	34.0	6.8-135	1-360	650,00
FG 543/DG2	1/2"	480	43.0	10-200	1-360	770,00

GONIOMETRO DIGITALE PER SERRAGGI IN COPPIA E ANGOLARI

Precisione di serraggio $\pm 2\%$
 Destorso e Sinistrorso
 Doppia modalità di misurazione: PICCO e TRACCIA
 Indicatore sonoro e visivo a 6 led al raggiungimento della coppia prefissata
 Possibilità di memorizzare fino a 50 differenti serraggi
 Alimentazione: 2 batterie 1.5V



CODICE	A/mm	H/mm	Nm	Gradi	€/PZ
FG 546/DG	85	80	10-200	1-360	320,00

GONIOMETRO DIGITALE PER SERRAGGI ANGOLARI

Precisione di serraggio $\pm 2\%$
 Destorso e Sinistrorso
 Indicatore sonoro e visivo a 6 led al raggiungimento della coppia prefissata
 Dotato di supporto magnetico posteriore



CODICE	A/mm	H/mm	Gradi	€/PZ
FG 547/DG	58	41	1-360	205,00

BARRA DINAMOMETRICA A DISINNESTO PER SERRAGGI DESTORSI E SINISTRORSI

Precisione $\pm 4\%$ - Fornita in cassetta di ABS



CODICE	■	N/mm	L/mm	€/PZ
FG 538/1	3/4"	140-560	996	800,00
FG 538/2	3/4"	200-800	1.070	880,00

BARRA DINAMOMETRICA A DISINNESTO PER SERRAGGI DESTORSI E SINISTRORSI

Precisione $\pm 4\%$ - Fornita in cassetta di ABS



CODICE	■	N/mm	L/mm	€/PZ
FG 539/1	1"	200-1000	1.400	1.150,00

CHIAVE DINAMOMETRICA A DISINNESTO PER SERRAGGI DESTORSI E SINISTRORSI

NEW

Precisione $\pm 4\%$ - Fornita in cassetta di ABS
 Testa a cricchetto con rilascio rapido
 Impugnatura ergonomica con anello di regolazione



CODICE	n	N/mm	L/mm	€/PZ
FG 540/1	3/4"	150-750	1210	1.050,00
FG 540/2	3/4"	200-1000	1500	1.200,00

CHIAVE DINAMOMETRICA A DISINNESTO PER SERRAGGI DESTORSI E SINISTRORSI

Precisione $\pm 4\%$ - Fornita in cassetta di ABS



CODICE	■	Nm	A/mm	L/mm	€/PZ
FG 537/1	3/4"	110-550	61.0	845	1.400,00

CHIAVE DINAMOMETRICA A DISINNESTO PER SERRAGGI DESTORSI

Precisione $\pm 4\%$
 Fornita in cassetta di ABS
 Serie speciale in alluminio



CODICE	■	Nm	Peso gr	L/mm	€/PZ
FG 537/AL1	3/4"	110-550	3.000	820	1.450,00
FG 537/AL2	3/4"	140-760	3.000	820	1.600,00
FG 537/AL3	3/4"	200-1.000	3.000	820	1.900,00
FG 539/AL1	1"	600-1.500	10.900	1.615	2.750,00



CHIAVE DINAMOMETRICA A INNESTO FEMMINA

Precisione $\pm 3\%$ 

CODICE	Nm	Risoluzione	□ x ■	€/PZ
FG 542/4	60-300	1.0	14x18	290,00

CHIAVE DINAMOMETRICA A INNESTO FEMMINA 9X12MM

Precisione $\pm 4\%$ 

CODICE	Nm	Risoluzione	□ x ■	€/PZ
FG 544/1	5-25	0.1	9x12	195,00
FG 544/2	10-50	0.25	9x12	216,00
FG 544/3	20-100	0.5	9x12	232,00
FG 544/4	40-200	1.0	14x18	278,00

CHIAVE A FORCHETTA PER BARRA DINAMOMETRICA



CODICE	mm	Attacco	€/PZ
FG 546/A7	7	9x12	25,00
FG 546/A8	8	9x12	25,00
FG 546/A10	10	9x12	25,00
FG 546/A12	12	9x12	25,00
FG 546/A13	13	9x12	25,00
FG 546/A14	14	9x12	26,00
FG 546/A15	15	9x12	28,00
FG 546/A16	16	9x12	28,00
FG 546/A17	17	9x12	28,00
FG 546/A18	18	9x12	28,00
FG 546/A19	19	9x12	28,00

CHIAVE A FORCHETTA PER BARRA DINAMOMETRICA



CODICE	mm	Attacco	€/PZ
FG 547/A13	13	14x18	31,50
FG 547/A14	14	14x18	31,50
FG 547/A15	15	14x18	31,50
FG 547/A16	16	14x18	31,50
FG 547/A17	17	14x18	31,50
FG 547/A18	18	14x18	31,50
FG 547/A19	19	14x18	31,50
FG 547/A21	21	14x18	35,00
FG 547/A22	22	14x18	35,00
FG 547/A24	24	14x18	36,00
FG 547/A27	27	14x18	42,00
FG 547/A30	30	14x18	46,00
FG 547/A32	32	14x18	50,00
FG 547/A34	34	14x18	60,00
FG 547/A36	36	14x18	68,00
FG 547/A41	41	14x18	88,00

CRICCHETTO REVERSIBILE PER BARRA DINAMOMETRICA



CODICE	Attacco	■	€/PZ
FG 545/1	9x12	1/4"	40,00
FG 545/2	9x12	3/8"	46,00
FG 545/3	9x12	1/2"	49,00
FG 545/4	14x18	1/2"	52,00

CHIAVE POLIGONALE PER BARRA DINAMOMETRICA



CODICE	mm	Attacco	€/PZ
FG 548/A7	7	9x12	27,00
FG 548/A8	8	9x12	27,00
FG 548/A10	10	9x12	27,00
FG 548/A12	12	9x12	27,00
FG 548/A13	13	9x12	27,00
FG 548/A14	14	9x12	27,00
FG 548/A15	15	9x12	28,00
FG 548/A16	16	9x12	28,00
FG 548/A17	17	9x12	28,00
FG 548/A18	18	9x12	28,00
FG 548/A19	19	9x12	28,00
FG 548/A21	21	9x12	33,00
FG 548/A22	22	9x12	35,00

CHIAVE POLIGONALE PER BARRA DINAMOMETRICA



CODICE	mm	Attacco	€/PZ
FG 549/A13	13	14x18	33,00
FG 549/A14	14	14x18	33,00
FG 549/A15	15	14x18	33,00
FG 549/A16	16	14x18	33,00
FG 549/A17	17	14x18	34,00
FG 549/A18	18	14x18	34,00
FG 549/A19	19	14x18	34,00
FG 549/A21	21	14x18	38,00
FG 549/A22	22	14x18	38,00
FG 549/A24	24	14x18	40,00
FG 549/A27	27	14x18	43,00
FG 549/A30	30	14x18	46,00
FG 549/A32	32	14x18	49,00
FG 549/A34	34	14x18	60,00
FG 549/A36	36	14x18	68,00
FG 549/A41	41	14x18	88,00

GIRAVITE DINAMOMETRICO A TARATURA LIBERA

Precisione di serraggio $\pm 6\%$



CODICE	Attacco esagonale	Nm	L/mm	€/PZ
FG 559/1	1/4"	0.1-1.2	155	220,00
FG 559/2	1/4"	1-6	155	230,00

MINI MOLTIPLICATORE DI COPPIA DESTROSO/SINISTROSO

1/2" x 1/2"

Rapporto: 3.4:1



CODICE	Massima uscita	Nm	€/PZ
FG 580/A	600	445	270,00
FG 580/B	800	590	370,00

MINI MOLTIPLICATORE DI COPPIA DESTROSO/SINISTROSO



CODICE	□ x ■	Rapporto	Nm	lb.ft	€/PZ
FG 581/A	1/2" x 3/4"	1:6.5	231-1.500	1.106	800,00
FG 581/B	1/2" x 1"	1:12	208-2.500	1.844	1.320,00

CHIAVE DINAMOMETRICA PRE-TORQUE ANTI-MANOMISSIONE CON INNESTO FEMMINA 9X12MM

Precisione $\pm 3\%$



CODICE	□	Nm	L/mm	€/PZ
FG 551/1	9x12	1-20	203	240,00

CHIAVE DINAMOMETRICA PRE-TORQUE ANTI-MANOMISSIONE CON INNESTO FEMMINA

Precisione $\pm 3\%$



CODICE	□	Nm	L/mm	€/PZ
FG 552/1	9x12	8-60	280	275,00
FG 552/2	9x12	10-100	319	275,00
FG 552/3	14x18	40-200	400	310,00

CHIAVE DINAMOMETRICA PRE-TORQUE ANTI-MANOMISSIONE CON INNESTO FEMMINA 9X12MM

Precisione $\pm 3\%$

Oscillazione di 20°



CODICE	□	Nm	L/mm	€/PZ
FG 553/1	9x12	5-25	240	295,00

CHIAVE DINAMOMETRICA PRE-TORQUE ANTI-MANOMISSIONE CON INNESTO FEMMINA

Precisione $\pm 6\%$



CODICE	□	Nm	L/mm	€/PZ
FG 558/2	1/4"	1-6	195	220,00





06

UTENSILI DA PERCUSSIONE



MARTELLINO TIPO TEDESCO CON MANICO IN LEGNO



CODICE	Gr	L/mm	€/PZ
FG 132/H200	200	280	14,00
FG 132/H300	300	300	16,00
FG 132/H500	500	320	20,00
FG 132/H800	800	350	26,00
FG 132/H1000	1.000	360	29,00
FG 132/H1500	1.500	380	36,00

MANICO IN LEGNO PER MARTELLINO TIPO TEDESCO



CODICE	Gr	€/PZ
FG 132/H200-M	200	5,70
FG 132/H300-M	300	6,50
FG 132/H500-M	500	7,50
FG 132/H800-M	800	8,70
FG 132/H1000-M	1000	9,00
FG 132/H1500-M	1500	9,80

MAZZETTA CON MANICO IN LEGNO E COLLARE SALVAMANICO



CODICE	Gr	L/mm	€/PZ
FG 134/H800	800	260	22,00
FG 134/H1000	1.000	262	23,00
FG 134/H1250	1.250	262	25,50
FG 134/H1500	1.500	280	29,50
FG 134/H2000	2.000	300	36,00

MANICO IN LEGNO PER MAZZETTA



CODICE	Gr	€/PZ
FG 134/H800-M	800	6,70
FG 134/H1000-M	1000	6,70
FG 134/H1250-M	1250	7,20
FG 134/H1500-M	1500	7,20
FG 134/H2000-M	2000	8,00

MARTELLINO TIPO TEDESCO CON MANICO IN RESINA



CODICE	Gr	L/mm	€/PZ
FG 132/200	200	294	18,50
FG 132/300	300	297	20,50
FG 132/500	500	312	21,50
FG 132/800	800	342	27,00
FG 132/1000	1.000	343	29,50

MAZZUOLA CON TESTA IN RAME E MANICO IN LEGNO



CODICE	Gr	L/mm	€/PZ
FG 134/R300	250	280	36,00
FG 134/R500	500	310	55,00
FG 134/R800	800	316	82,00
FG 134/R1000	1.000	330	98,00

MARTELLINO A TESTA TONDA E PENNA SFERICA



CODICE	Gr	L/mm	€/PZ
FG 133/H340	340	330	25,50
FG 133/H540	540	360	32,50
FG 133/H910	910	405	37,50

MARTELLINO TIPO FRANCESE CON MANICO IN LEGNO



CODICE	Gr	L/mm	€/PZ
FG 132/E200	200	260	15,00

MAZZETTA IN GOMMA ANTI-RIMBALZO



CODICE	Ø/mm/mm	Gr/Oz	L/mm	€/PZ
FG 135/45	45	500/18	295	33,00
FG 135/50	50	795/28	320	34,00
FG 135/60	60	1.270/44	360	46,50

MAZZUOLA ANTI-RIMBALZO CON BATTENTI INTERCAMBIABILI IN PLASTICA



CODICE	Ø/mm/mm	L/mm	€/PZ
FG 136/L22	22	260	20,00
FG 136/L28	28	280	25,00
FG 136/L35	35	310	33,00
FG 136/L42	42	320	52,00
FG 136/L50	50	350	70,00
FG 136/L60	60	380	85,00

MANICO DI RICAMBIO



CODICE	€/PZ
FG 136/L22-M	5,30
FG 136/L28-M	5,30
FG 136/L35-M	6,20
FG 136/L42-M	6,40
FG 136/L50-M	7,40
FG 136/L60-M	8,20

BATTENTI DI RICAMBIO

Prezzo per coppia

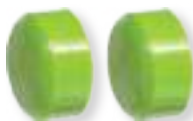

CODICE	€/PZ
FG 136L/R22	3,10
FG 136L/R28	4,80
FG 136L/R35	6,00
FG 136L/R42	11,00
FG 136L/R50	14,90
FG 136L/R60	18,00

MAZZUOLA ANTI-RIMBALZO CON BATTENTI INTERCAMBIABILI IN PLASTICA



CODICE	Ø/mm	L/mm	€/PZ
FG 136/30	30	310	52,00
FG 136/40	40	320	65,00
FG 136/50	50	350	75,00

BATTENTI DI RICAMBIO

Prezzo per coppia

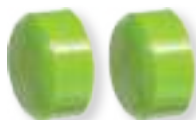

CODICE	€/PZ
FG 136/R30	8,80
FG 136/R40	10,80
FG 136/R50	16,50

SCALPELLO NERVATO

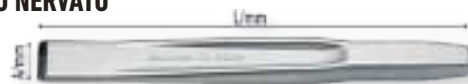

CODICE	L/mm	A/mm	Q.tà min.	€/PZ
FG 126/SN1	125	17.0	5	12,50
FG 126/SN2	150	21.0	5	14,50
FG 126/SN3	200	25.0	5	23,50
FG 126/SN4	250	29.0	3	32,50
FG 126/SN5	300	34.0	3	44,00

SCALPELLO NERVATO CON PARAMANO DI SICUREZZA



CODICE	Gr	L/mm	€/PZ
FG 126/SN4S	250	29.0	42,00
FG 126/SN5S	300	34.0	54,00

PARAMANO DI SICUREZZA PER SCALPELLO NERVATO



CODICE	Indicato per	€/PZ
FG 126SH/SN4	FG 127/SN4	9,50
FG 126SH/SN5	FG 126/SN5	9,50

SCALPELLO EXTRA-PIATTO



CODICE	L/mm	A/mm	Q.tà min.	€/PZ
FG 127/P1	240	26.0	5	18,00

SCALPELLO EXTRA-PIATTO CON PARAMANO DI SICUREZZA



CODICE	L/mm	A/mm	€/PZ
FG 127/P1S	240	26.0	28,00

PARAMANO DI SICUREZZA PER SCALPELLO EXTRA-PIATTO



CODICE	Indicato per	€/PZ
FG 127SH/P1	FG 127/P1	10,50



BEDANO

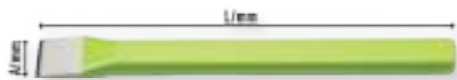

CODICE	L/mm	A/mm	Q.tà min.	€/PZ
FG 127/BE1	100	15.0	5	8,60
FG 127/BE2	125	15.0	5	9,00
FG 127/BE3	150	18.0	5	9,45
FG 127/BE4	175	21.0	5	13,50
FG 127/BE7	250	28.0	3	21,00

BEDANO CON PARAMANO DI SICUREZZA



CODICE	Gr	L/mm	€/PZ
FG 127/BE7S	250	28.0	29,00

PARAMANO DI SICUREZZA



CODICE	€/PZ
FG 127SH/BE5-8	8,50

SCALPELLO PIATTO

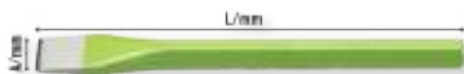

CODICE	L/mm	A/mm	Q.tà min.	€/PZ
FG 128/S20	175	20.0	5	13,50

SCALPELLO CON TAGLIANTE LATERALE

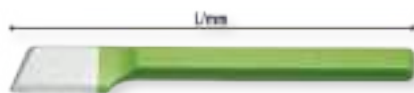

CODICE	L/mm	Q.tà min.	€/PZ
FG 129/S20	200	3	12,50

UGNETTO STANDARD



CODICE	L/mm	Ømm	Q.tà min.	€/PZ
FG 128/U5	125	6.0	5	8,00

PUNTA PER EDILIZIA

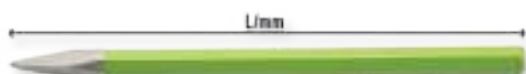

CODICE	L/mm	Ømm	Q.tà min.	€/PZ
FG 127/PU1	250	4.0	5	11,50
FG 127/PU2	300	6.0	5	13,50

PUNTA PER EDILIZIA



CODICE	L/mm	Ømm	Q.tà min.	€/PZ
FG 126/SL1	200	12-0	5	7,50
FG 126/SL2	250	12.0	5	8,50

PUNTA PER EDILIZIA CON PARAMANO DI SICUREZZA



CODICE	Gr	L/mm	€/PZ
FG 127/PU2S	300	6.0	21,00

PARAMANO DI SICUREZZA PER PUNTA PER EDILIZIA



CODICE	Indicato per	€/PZ
FG 127SH/PU2	FG 127/PU2	7,50

BULINO AUTOMATICO



CODICE	L/mm	Ømm	Q.tà min.	€/PZ
FG 128/BU	120.0	4.0	3	26,00

BULINO A PERCUSSIONE

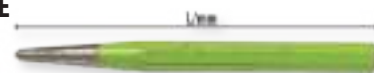

CODICE	L/mm	Ømm	Q.tà min.	€/PZ
FG 128/BU2	134.0	3.0	3	8,50

SET 6 UTENSILI A PERCUSSIONE



CODICE	Contenuto	€/PZ
FG 127/S1	6	49,50

CONTENUTO

	FG 126/S12, FG128/S16
	FG 126/P4, FG 128/P3
	FG 128/BU2
	FG 128/U5

SET 6 CACCIASPINE



CODICE	Misure	€/PZ
FG 128C/S6	2, 3, 4, 5, 6, 8mm	46,50

SET 6 PUNZONI



CODICE	Misure	€/PZ
FG 128P/S6	1, 2, 3, 4, 5, 6mm	41,50

CACCIASPINE STANDARD

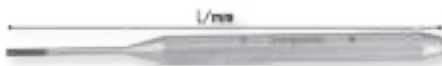

CODICE	L/mm	Ømm	Q.tà min.	€/PZ
FG 129/C2	150	2.0	5	7,50
FG 129/C3	150	3.0	5	7,50
FG 129/C4	150	4.0	5	8,00
FG 129/C5	150	5.0	5	8,00
FG 129/C6	150	6.0	5	9,00
FG 129/C8	150	8.0	5	9,50
FG 129/C10	150	10.0	5	11,50

SET 6 CACCIASPINE



CODICE	Misure	€/PZ
FG 129C/S6	2, 3, 4, 5, 6, 8, mm	54,00

PUNZONE STANDARD



CODICE	L/mm	Ømm	Q.tà min.	€/PZ
FG 129/P1	120	1.0	5	6,90
FG 129/P2	120	2.0	5	6,90
FG 129/P3	120	3.0	5	7,80
FG 129/P4	120	4.0	5	7,80
FG 129/P5	120	5.0	5	7,80
FG 129/P6	120	6.0	5	7,80

SET 6 PUNZONI



CODICE	Misure	€/PZ
FG 129P/S6	1, 2, 3, 4, 5, 6mm	46,50

SCALPELLO PIATTO

Superior line



CODICE	L/mm	A/mm	Q.tà min.	€/PZ
FG 129/S125	125	14.0	5	12,50
FG 129/S150	150	17.0	5	15,00
FG 129/S170	175	20.0	5	19,50

CACCIASPINE CON IMPUGNATURA



CODICE	L/mm	Ømm	Q.tà min.	€/PZ
FG 128/CA2	140	2.0	5	8,50
FG 128/CA3	149	3.0	5	8,50
FG 128/CA4	180	4.0	5	10,00
FG 128/CA5	200	5.0	5	10,50
FG 128/CA6	210	6.0	5	14,00
FG 128/CA7	210	8.0	5	14,00
FG 128/CA8	220	6.0	5	15,00

SET 11 UTENSILI DA PERCUSSIONE CON IMPUGNATURA



CODICE	Contenuto	€/PZ
FG 128/S11	FG 128/SC12, FG 128/SC16, FG 128/PU2, FG 128/PU10	119,50





FASANO
PC 40/TGX

—
07
—

UTENSILI DA TAGLIO



CUTTER A SERRAMANICO CON LAMA TRAPEZOIDALE

Fornito con 3 lame di ricambio



CODICE	L/mm	€/PZ
FG 48/B	110-180	21,70

KIT 12 LAME TRAPEZOIDALI



CODICE	€/PZ
FG 48/K12	8,50

CUTTER PROFESSIONALE A STILO

Fornito con 3 lame di ricambio



CODICE	L/mm	€/PZ
FG 48/P	142	10,30

KIT 10 LAME DI RICAMBIO



CODICE	€/PZ
FG 48/PL	6,70

CUTTER EXTRA PIATTO CON LAMA DA 9MM

Acciaio inox



CODICE	L/mm	€/PZ
FG 48/L9	134	7,30

KIT 10 LAME TRAPEZOIDALI



CODICE	mm	€/PZ
FG 48/KL9	0.4x9x73.4	6,20

CUTTER PROFESSIONALE CON LAMA LUNGA



CODICE	L/mm	€/PZ
FG 48/L	164	9,30

KIT 10 LAME TRAPEZOIDALI



CODICE	mm	€/PZ
FG 48/KL10	0.5x18x100	6,20

CUTTER PROFESSIONALE CON LAMA LUNGA



CODICE	L/mm	€/PZ
FG 48/LG	16.7	9,30

KIT 10 LAME TRAPEZOIDALI



CODICE	mm	€/PZ
FG 48/KL10	0.5x18x100	6,20

FORBICI DA ELETTRICISTA DOTATE DI INCAVO SPELLAFILI

Lama microdentata in acciaio

HRC: 56

Struttura integrale in acciaio Inox

Tagliacavi 12mm

Con supporto per cintura



CODICE	L/mm	A/mm	€/PZ
FG 49/TC	140	65	41,00

FORBICI DA ELETTRICISTA DOTATE DI INCAVO SPELLAFILI

Lama microdentata in acciaio
HRC: 56
Struttura integrale in acciaio Inox
Tagliacavi 15mm
Con supporto per cintura

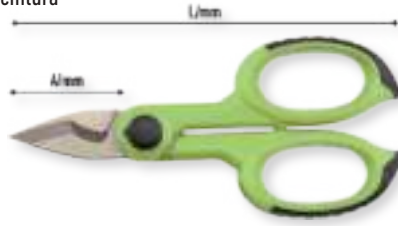

CODICE	L/mm	A/mm	€/PZ
FG 49/TCX	160	50	48,00

FORBICI DA ELETTRICISTA DOTATE DI INCAVO SPELLAFILI



CODICE	L/mm	A/mm	€/PZ
FG 49	137	45	16,50

FORBICI MULTIUSO A LAME LUNGHE IN ACCIAIO INOX

HRC: 52-54



CODICE	L/mm	A/mm	Apertura max	€/PZ
FG 49/L	200	87	151	18,00

FORBICI MULTIUSO CON GOLA SPELLAFILI E LAME IN ACCIAIO INOX ZIGRINATE

HRC: 52-54



CODICE	L/mm	Lama	Spellafili	€/PZ
FG 49/MU	203	52	1.0, 1.5, 2.0 mm ²	26,50

TRONCA TUBI CON LAMA INTERCAMPABIABILE IN ACCIAIO INOX

HRC: 48-52

Per tubi in gomma



CODICE	L/mm	Capacità	€/PZ
FG 77/TT	226	3-36mm	9,90

CESOIA MULTIUSO CON LAME IN ACCIAIO INOX LARGHE DRITTE - MODELLO PESANTE

HRC: 58-61



CODICE	L/mm	Acciaio	Inox	€/PZ
FG 49/HE200	200	0.53mm	0.36mm	22,00
FG 49/HE250	250	0.78mm	0.46mm	25,80
FG 49/HE300	300	0.94mm	0.78mm	32,00
FG 49/HE350	350	1.24mm	0.78mm	40,00

CESOIA A DOPPIA LEVA E LAME IN ACCIAIO INOX DRITTE

HRC: 60-62

Capacità di taglio per acciaio: 0-1.2mm

Capacità di taglio per Inox: 0-0.7mm



CODICE	L/mm	Apertura max	€/PZ
FG 49/CS	252	21mm	27,50

CESOIA A DOPPIA LEVA E LAME IN ACCIAIO INOX SINISTRORSE

HRC: 60-62

Capacità di taglio per acciaio: 0-1.2mm

Capacità di taglio per Inox: 0-0.7mm



CODICE	L/mm	Apertura max	€/PZ
FG 49/CL	245	17mm	27,50

CESOIA A DOPPIA LEVA E LAME IN ACCIAIO INOX DESTRORE

HRC: 60-62

Capacità di taglio per acciaio: 0-1.2mm

Capacità di taglio per Inox: 0-0.7mm



CODICE	L/mm	Apertura max	€/PZ
FG 49/CR	245	17mm	27,50



TRONCABULLONI

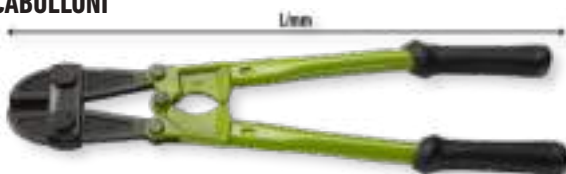

CODICE	L/mm - pollici	Capacità	€/PZ
FG 67/350	350-14"	3-10mm	48,00
FG 67/450	450-18"	5-16mm	61,00
FG 67/600	600-24"	8-22mm	82,50
FG 67/750	750-30"	9-25mm	107,00
FG 67/900	900-36"	10-26mm	135,00

LAME DI RICAMBIO



CODICE	Per	€/PZ
FG 67/350R	FG 67/350	21,50
FG 67/450R	FG 67/450	26,00
FG 67/600R	FG 67/600	34,50
FG 67/750R	FG 67/750	48,50
FG 67/900R	FG 67/900	64,50

ARCHETTO ERGONOMICO DOTATO DI LAMA HSS BI-METAL

Lama posizionabile a 0 e 40 gradi



CODICE	L/mm	Lama mm	€/PZ
FG 50/ME	402	300	38,00

ARCHETTO SEMPLICE DOTATO DI LAMA HSS BI-METAL

Tensionamento lama integrato



CODICE	L/mm	Lama mm	€/PZ
FG 50/SE	402	300	26,50

ARCHETTO PESANTE DOTATO DI LAMA HSS BI-METAL

Sistema di tensionamento a volantino



CODICE	L/mm	Lama mm	€/PZ
FG 50/PE	515	300	17,50

MINI-ARCHETTO IN ABS E LAMA CARBON STEEL A 24 DENTI

Lama regolabile a 45, 90, 135 e 180 gradi



CODICE	L/mm	Lama mm	€/PZ
FG 50/MS	270	150	7,50

SEGNETTO MONO-IMPUGNATURA E LAMA FISSA HSS BI-METAL 24 DENTI



CODICE	L/mm	Lama mm	€/PZ
FG 50/MN	405	130	12,00

LAMA DI RICAMBIO

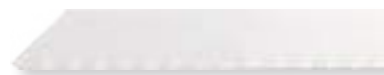

CODICE	€/PZ
FG 50/MN-B	6,50

SEGNETTO MONO-IMPUGNATURA E LAMA FISSA HSS BI-METAL 24 DENTI



CODICE	L/mm	Lama mm	€/PZ
FG 50/MI	312	150	8,50

SEGNETTO COMPATTO CON IMPUGNATURA

NEW



CODICE	L/mm	Lama mm	€/PZ
FG 50/AR	262	140	13,50

KIT LAME CARBONIO



CODICE	L/mm	Contenuto	Per	€/PZ
FG 50/MSL	150	10	FG 50/MS - FG 50/MI	10,50
FG 50/MIL	300	10	FG 50/ME - FG 50/PE	15,00

KIT LAME HSS BI-METAL

CODICE	L/mm	Contenuto	Per	€/PZ
FG 50/LBM	300	10	FG 50/SE	27,00

RASPE CON IMPUGNATURA

L/mm 200



CODICE	Lama	€/PZ
FG 82/RT	Semi-tonda	11,50
FG 82/RST	Piatta	11,50

LIME CON IMPUGNATURA A TAGLIO MEZZODOLCE 8"

Impugnatura ergonomica in bi-materiale

Provviste di gancio di appendimento

L/mm 200



CODICE	Forma	€/PZ
FG 80/8AR	Tonda	15,00
FG 80/8AM	Mezzotonda	15,00
FG 80/8AP	Piatta	17,00
FG 80/8AT	Triangolare	15,00
FG 80/8AQ	Quadrata	17,00

SET



SET LIME A TAGLIO MEZZODOLCE

Fornito in supporto di cartone

CODICE	Taglio	Contenuto	€/PZ
FG 80/S5B	Mezzodolce	5	78,00

LIME CON IMPUGNATURA A TAGLIO BASTARDO 8"

Impugnatura ergonomica in bi-materiale

Provviste di gancio di appendimento

L/mm 200



CODICE	Forma	€/PZ
FG 81/8AR	Tonda	11,50
FG 81/8AM	Mezzotonda	15,00
FG 81/8AP	Piatta	14,50
FG 81/8AT	Triangolare	14,50
FG 81/8AQ	Quadrata	15,50

SET



SET LIME A TAGLIO BASTARDO

Fornito in supporto di cartone

CODICE	Taglio	Contenuto	€/PZ
FG 81/S5B	Bastardo	5	75,00

LIME AD AGO CON IMPUGNATURA IN PVC

L/mm 160

Quantità minima 5 pz



CODICE	Forma	€/PZ
FG 83/AR	Tonda	5,00
FG 83/AT	Triangolare	5,00
FG 83/AQ	Quadrata	5,00
FG 83/AM	Mezzotonda	5,00
FG 83/AP	Piatta	5,00
FG 83/AW	A foglia	5,00

SET

SET LIME AD AGO CON IMPUGNATURA IN CUSTODIA DI NYLON

CODICE	€/PZ
FG 83/S6	30,00

SERIE 3 MASCHI A MANO IN ACCIAIO HSS - PASSO GROSSO E FILETTATURA METRICA

DIN 352 - HRC 63-66



CODICE	Ømm	□mm	L1/mm	L/mm	€/PZ
FG 71/M3x0,5	3x0,5	3,5	11	40	12,50
FG 71/M4x0,7	4x0,7	3,5	13	45	12,50
FG 71/M5x0,8	5x0,8	6,0	16	48	14,00
FG 71/M6x1	6x1	6,0	19	50	14,00
FG 71/M7x1	7x1	6,0	19	50	17,00
FG 71/M8x1,25	8x1,25	6,0	22	56	17,00
FG 71/M10x1,5	10x1,5	7,0	24	70	20,00
FG 71/M12x1,75	12x1,75	9,0	29	75	28,00
FG 71/M14x2	14x2	11,0	30	80	39,00
FG 71/M16x2	16x2	12,0	32	80	39,00
FG 71/M18x2,5	18x2,5	14,0	40	95	60,00
FG 71/M20x2,5	20x2,5	16,0	40	95	70,00
FG 71/M22x2,5	22x2,5	18,0	40	100	90,00
FG 71/M24x3	24x3	18,0	50	110	110,00



SERIE 2 MASCHI A MANO IN ACCIAIO HSS - PASSO FINE E FILETTATURA METRICA

DIN 2181 - HRC 63-66



CODICE	Ømm	□mm	L1/mm	L/mm	€/PZ
FG 72/M6x0,75	6x0.75	6.0	19	50	9,00
FG 72/M7x0,75	7x0.75	6.0	19	50	11,00
FG 72/M8x0,75	8x0.75	6.0	22	56	11,00
FG 72/M8x1	8x1	6.0	22	56	11,00
FG 72/M9x1	9x1	7.0	22	63	13,00
FG 72/M10x0,75	10x0.75	7.0	24	70	13,00
FG 72/M10x1	10x1	7.0	24	70	13,00
FG 72/M10x1,25	10x1.25	7.0	24	70	13,00
FG 72/M11x1	11x1	8.0	24	70	18,50
FG 72/M12x1	12x1	9.0	29	75	18,50
FG 72/M12x1,25	12x1.25	9.0	29	75	18,50
FG 72/M12x1,5	12x1.5	9.0	29	75	18,50
FG 72/M13x1,5	13x1.5	9.0	29	75	26,50
FG 72/M14x1	14x1	11.0	30	80	26,50
FG 72/M14x1,25	14x1.25	11.0	30	80	26,50
FG 72/M14x1,5	14x1.5	11.0	30	80	26,50
FG 72/M15x1,5	15x1.5	12.0	32	80	32,00
FG 72/M16x1	16x1	12.0	32	80	32,00
FG 72/M16x1,5	16x1.5	12	40	80	32,00
FG 72/M18x1,5	18x1.5	14.0	40	95	40,00
FG 72/M18x2	18x2	14.0	40	95	40,00
FG 72/M20x1,25	20x1.25	16.0	40	95	47,00
FG 72/M20x1,5	20x1.5	16.0	40	95	47,00
FG 72/M20x2	20x2	16.0	40	95	47,00
FG 72/M22x1,5	22x1.5	18.0	40	100	64,00
FG 72/M24x1	24x1	18.0	50	110	64,00
FG 72/M24x1,5	24x1.5	18.0	50	110	75,00
FG 72/M24x2	24x2	18.0	50	110	75,00

GIRAMASCHI MANUALE REGOLABILE CON CORPO IN ZINCO

DIN 1814



CODICE	Capacità	Ømm	L/mm	€/PZ
FG 72/GMM0	M1-M8	2÷5mm	130	7,30
FG 72/GMM1	M1-M10	2÷6.3mm	190	8,30
FG 72/GMM1,5	M1-M12	2.1÷8mm	217	8,30
FG 72/GMM2	M4-M12	3÷9mm	280	15,50
FG 72/GMM3	M5-M20	4.9÷12mm	380	25,30
FG 72/GMM4	M9-M27	5.5÷16mm	500	32,00
FG 72/GMM5	M13-M32	7÷18mm	700	41,00

GIRAMASCHI A CRICCHETTO REVERSIBILE CORTO



CODICE	M	BSW	L/mm	€/PZ
FG 72/GMC1	M3-M10	1/8-3/8	85	18,00
FG 72/GMC2	M5-M12	7/32-1/2	85	23,00

GIRAMASCHI A CRICCHETTO REVERSIBILE LUNGO



CODICE	M	BSW	L/mm	€/PZ
FG 72/GMC3	M3-M10	1/8-3/8	300	28,90
FG 72/GMC4	M5-M12	7/32-1/2	300	35,00

FILIERA IN ACCIAIO HSS - PASSO GROSSO E FILETTATURA METRICA

DIN 223 - HRC 63-65



CODICE	Ømm	€/PZ
FG 73/M3x0,5	20x5	9,00
FG 73/M4x0,7	20x5	9,00
FG 73/M5x0,8	20x7	9,00
FG 73/M6x1	20x7	9,00
FG 73/M7x1	25x9	12,00
FG 73/M8x1,25	25x9	12,50
FG 73/M10x1,5	30x11	19,00
FG 73/M12x1,75	38x14	21,50
FG 73/M14x2	38x14	21,50
FG 73/M16x2	45x18	33,00
FG 73/M18x2,5	45x18	33,00
FG 73/M20x2,5	45x18	33,00
FG 73/M22x2,5	55x22	50,00
FG 73/M24x3	55x22	50,00

FILIERA IN ACCIAIO HSS - PASSO FINE E FILETTATURA METRICA

DIN 223 - HRC 63-65



CODICE	Ømm	€/PZ
FG 74/M6x0,75	20x7	9,00
FG 74/M7x0,5	25x9	12,00
FG 74/M8x0,75	25x9	12,00
FG 74/M8x1	25x9	12,00
FG 74/M9x0,75	25x9	12,00
FG 74/M9x1	25x9	12,00
FG 74/M9x1,25	25x9	12,00
FG 74/M10x0,5	30x11	18,50
FG 74/M10x0,75	30x11	18,50
FG 74/M10x1	30x11	18,50
FG 74/M10x1,25	30x11	18,50
FG 74/M11x0,5	30x11	18,50
FG 74/M11x0,75	30x11	18,50
FG 74/M11x1	30x11	18,50
FG 74/M12x0,75	38x14	31,00
FG 74/M12x1	38x14	31,00
FG 74/M12x1,25	38x14	31,00

CODICE	Ømm	€/PZ
FG 74/M12x1,5	38x14	31,00
FG 74/M14x1	38x14	31,00
FG 74/M14x1,25	38x14	31,00
FG 74/M14x1,5	38x14	31,00
FG 74/M15x1	38x14	31,00
FG 74/M16x1	45x14	46,00
FG 74/M16x1,5	45x14	46,00
FG 74/M18x1,5	45x14	46,00
FG 74/M20x1,25	45x14	46,00
FG 74/M20x1,5	45x14	46,00
FG 74/M20x2	45x14	46,00
FG 74/M21x1,5	45x14	46,00
FG 74/M22x1,5	55x16	73,00
FG 74/M24x1	55x16	73,00
FG 74/M24x1,5	55x16	73,00
FG 74/M24x2	55x16	73,00

GIRAFILIERE MANUALE REGOLABILE DIN 225



CODICE	Ømm	L/mm	€/PZ
FG 74/GF16x5	16x5	160	6,60
FG 74/GF20x5	20x5	200	6,60
FG 74/GF20x7	20x7	200	6,60
FG 74/GF25x9	25x9	224	7,50
FG 74/GF30x11	30x11	280	10,00
FG 74/GF38x14	38x14	315	18,50
FG 74/GF45x18	45x18	450	26,00
FG 74/GF55x22	55x22	560	26,00
FG 74/GF65x25	65x25	630	34,00

PUNTA MASCHIANTE CON ATTACCO ESAGONALE 1/4" PER TRAPANI E AVVITATORI HSS



CODICE	Ømm	L/mm	€/PZ
FG 74/PM3x0,5	3x0,5	36	18,50
FG 74/PM4x0,7	4x0,7	39	18,50
FG 74/PM5x0,8	5x0,8	41	18,50
FG 74/PM6x1	6x1	44	18,50
FG 74/PM8x1,25	8x1,25	50	20,50
FG 74/PM10x1,5	10x1,5	59	21,00

SET



SET PUNTE MASCHIANTI CON ATTACCO 1/4" + PROLUNGA

CODICE	Contenuto	€/PZ
FG 74PM/S7	M3-M10	118,00

SET 110 MASCHI E FILIERE IN ACCIAIO AL CROMO + ACCESSORI - PASSO GROSSO E FINE FILETTATURA METRICA



CODICE	Contenuto	€/PZ
FG 70/S110	110	335,00

CONTENUTO

Maschi passo grosso	2x0.4, 3x0.5, 4x0.7, 5x0.8, 6x1, 7x1, 8x1.25, 9x1.25, 10x1.5, 11x1.5, 12x1.75, 14x2, 16x2
Maschi passo fine	6x0.75, 7x0.75, 8x0.75, 8x1, 9x0.75, 9x1, 10x0.75, 10x1, 10x1.25, 11x0.75, 11x1, 11x1.25, 12x0.75, 12x1, 12x1.25, 12x1.5, 14x1, 14x1.25, 14x1.5, 16x1, 16x1.5, 18x1.5
Filiera passo grosso	2x0.4, 3x0.5, 4x0.7, 5x0.8, 6x1, 7x1, 8x1.25, 9x1.25, 10x1.5, 11x1.5, 12x1.75, 14x2, 16x2
Filiera passo fine	6x0.75, 7x0.75, 8x0.75, 8x1, 9x0.75, 9x1, 10x0.75, 10x1, 10x1.25, 11x0.75, 11x1, 11x1.25, 12x0.75, 12x1, 12x1.25, 12x1.5, 14x1, 14x1.25, 14x1.5, 16x1, 16x1.5, 18x1.5
	GF25x9, GF8x14, GMM1.5, GMM3, GMC1

SET 65 MASCHI E FILIERE IN HSS + ACCESSORI - PASSO GROSSO E FINE FILETTATURA METRICA

Fornito in box di ABS e moduli amovibili in gomma



CODICE	Contenuto	€/PZ
FG 70/S65	65	560,00

CONTENUTO

FG 71/M...	3x0.5, 4x0.7, 6x1, 7x1, 8x1.25, 10x1.5, 12x1.75, 14x2, 16x2, 18x2.5, 20x2.5
FG 72/M...	6x0.75, 8x1, 10x1.25, 12x1.25, 14x1.5, 16x1.5, 18x1.5
FG 73/M...	3x0.5, 4x0.7, 5x0.8, 6x1, 7x1, 8x1.25, 10x1.5
FG 74/M...	10x1.25, 12x1.5, 14x1.5, 16x1.5, 18x1.5
Accessori	FG 72/GMM1.5, FG 72/GMM3, FG 72/GMC1, FG 72 GMC2, FG 74 GF25x9, FG 74 GF45x18



FRESE CONICHE IN ACCIAIO HSS

Applicazione: lamiera d'acciaio



CODICE	Ømm	L/mm	€/PZ
FG 80HSS/1	3-14	58	22,00
FG 80HSS/2	6-20	70	40,00
FG 80HSS/3	16-30.5	75	75,00



SET

SET 3 FRESE CONICHE IN ACCIAIO HSS

Applicazione: lamiera d'acciaio

Fornito in box di ABS dotato di gancio di appendimento

CODICE	Contenuto	€/PZ
FG 80HSS/S3	3-14mm, 6-20mm, 16-30.5mm	145,00

FRESE CONICHE A GRADINO IN ACCIAIO HSS

Applicazione: lamiera d'acciaio

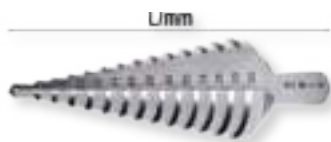

CODICE	Ømm	L/mm		€/PZ
FG 81HSS/1	4-12	65	1	45,00
FG 81HSS/2	4-20	75	2	62,00
FG 81HSS/3	4-30	100	2	135,00



SET

SET 3 FRESE CONICHE A GRADINO IN ACCIAIO HSS

Applicazione: lamiera d'acciaio

Fornito in box di ABS dotato di gancio di appendimento

CODICE	Contenuto	€/PZ
FG 81HSS/S3	3-12mm, 4-20mm, 4-30mm	245,00

LIMA ROTATIVA CILINDRICA IN METALLO DURO HM4



CODICE	Ømm	L2/mm	L1/mm	€/PZ
FG 80MD/ET3	3.0	16.0	38.0	13,00
FG 80MD/ET6	6.0	18.0	50.0	39,00
FG 80MD/ET12.7	6.0	25.0	70.0	68,00

LIMA ROTATIVA CILINDRICA IN METALLO DURO HM4



CODICE	Ømm	L2/mm	L1/mm	€/PZ
FG 80MD/ER3	3.0	16.0	38.0	13,00
FG 80MD/ER6	6.0	18.0	50.0	39,00
FG 80MD/ER12.7	6.0	25.0	70.0	68,00

LIMA ROTATIVA CILINDRICA IN METALLO DURO HM4



CODICE	Ømm	L2/mm	L1/mm	€/PZ
FG 80MD/SV3	3.0	16.0	38.0	13,00
FG 80MD/SV6	6.0	18.0	50.0	39,00
FG 80MD/SV12.7	6.0	25.0	70.0	68,00

LIMA ROTATIVA CILINDRICA IN METALLO DURO HM4



CODICE	Ømm	L2/mm	L1/mm	€/PZ
FG 80MD/EC3	3.0	16.0	38.0	13,00
FG 80MD/EC6	6.0	18.0	50.0	39,00
FG 80MD/EC12.7	6.0	25.0	70.0	68,00

LIMA ROTATIVA CILINDRICA IN METALLO DURO HM4



CODICE	Ømm	L2/mm	L1/mm	€/PZ
FG 80MD/CS3	3.0	3.0	38.0	13,00
FG 80MD/CS6	6.0	5.0	50.0	39,00
FG 80MD/CS12.7	6.0	10.0	70.0	68,00

LIMA ROTATIVA CILINDRICA IN METALLO DURO HM4



CODICE	Ømm	L2/mm	L1/mm	€/PZ
FG 80MD/AR3	3.0	16.0	38.0	13,00
FG 80MD/AR6	6.0	18.0	50.0	39,00
FG 80MD/AR12.7	6.0	25.0	70.0	68,00

FRESE A TAZZA IN ACCIAIO HSS BI-METAL

Profondità di taglio: 38mm - HRC: 60

Applicazioni: metallo, alluminio, PVC, materiale plastico



CODICE	Ømm	Pollici	H/ mm	RPM acciaio dolce	RPM inox	RPM acciaio fuso	RPM ottone	RPM allu- minio	€/PZ
FG 78/HSS14	14	9/16"	45	580	300	400	790	900	8,70
FG 78/HSS16	16	5/8"	45	550	275	365	730	825	8,70
FG 78/HSS17	17	11/16"	45	500	250	330	665	750	8,70
FG 78/HSS19	19	3/4"	45	460	230	300	600	690	8,70
FG 78/HSS20	20	25/32"	45	425	210	280	560	635	8,70
FG 78/HSS21	21	13/16"	45	425	210	280	560	635	8,90
FG 78/HSS22	22	7/8"	45	390	195	260	520	585	8,90
FG 78/HSS24	24	15/16"	45	370	185	245	495	555	8,90
FG 78/HSS25	25	1"	45	350	175	235	470	525	9,00
FG 78/HSS27	27	1.1/16"	45	325	160	215	435	480	9,10
FG 78/HSS28	28	1.1/16"	45	300	150	200	400	450	9,10
FG 78/HSS29	29	1.1/8"	45	300	150	200	400	450	9,10
FG 78/HSS30	30	1.3/16"	45	285	145	190	380	425	9,30
FG 78/HSS32	32	1.1/14"	45	275	140	180	360	410	9,90
FG 78/HSS33	33	1.5/16"	45	260	135	175	345	390	10,20
FG 78/HSS35	35	1.3/8"	45	250	125	165	330	375	10,90
FG 78/HSS37	37	1.7/16"	45	240	120	160	315	360	11,40
FG 78/HSS38	38	1.1/2"	45	230	115	150	300	345	11,40
FG 78/HSS40	40	1.9/16"	45	220	110	145	290	330	11,60
FG 78/HSS41	41	1.5/8"	45	210	105	140	280	315	11,90
FG 78/HSS43	43	1.11/16"	40	205	100	135	270	305	11,90
FG 78/HSS44	44	1.3/4"	40	195	95	130	260	295	12,10
FG 78/HSS46	46	1.13/16"	40	190	95	125	250	285	12,10
FG 78/HSS48	48	1.7/8"	40	180	90	120	240	270	12,10
FG 78/HSS50	50	2"	40	170	85	115	230	255	12,80
FG 78/HSS51	51	2.1/16"	40	165	80	110	220	245	12,80
FG 78/HSS52	52	2.1/16"	40	165	80	110	220	245	12,80
FG 78/HSS54	54	2.1/8"	40	160	80	105	210	240	14,00
FG 78/HSS57	57	2.1/4"	40	150	75	100	200	225	14,40
FG 78/HSS59	59	2.5/16"	40	145	75	100	195	225	14,40
FG 78/HSS60	60	2.3/8"	40	140	70	95	190	220	15,00
FG 78/HSS64	64	2.1/2"	40	135	65	90	180	205	15,10
FG 78/HSS65	65	2.9/16"	40	130	65	85	175	200	15,50
FG 78/HSS67	67	2.5/8"	40	130	65	85	170	195	15,80
FG 78/HSS68	68	2.11/16"	40	130	65	85	170	195	15,80
FG 78/HSS70	70	2.3/4"	40	125	60	80	160	185	16,70
FG 78/HSS73	73	2.7/8"	40	120	60	80	160	180	17,00
FG 78/HSS76	76	3"	40	115	55	75	150	170	17,90
FG 78/HSS79	79	3.1/8"	40	110	55	70	140	165	19,00
FG 78/HSS83	83	3.1/4"	40	105	50	70	140	155	21,70
FG 78/HSS86	86	3.3/8"	40	100	50	65	130	150	22,20
FG 78/HSS89	89	3.1/2"	40	95	45	65	130	145	22,70
FG 78/HSS92	92	3.5/8"	40	95	45	60	120	140	23,70
FG 78/HSS95	95	3.3/4"	40	90	45	60	120	135	24,80
FG 78/HSS98	98	3.7/8"	40	90	45	60	120	135	25,80
FG 78/HSS102	102	4"	40	85	40	55	110	130	27,90
FG 78/HSS105	105	4.1/8"	40	80	40	55	110	120	29,40
FG 78/HSS108	108	4.1/4"	40	80	40	55	110	120	30,40
FG 78/HSS111	111	4.3/8"	40	80	40	50	100	120	32,00
FG 78/HSS114	114	4.1/2"	40	75	35	50	100	105	34,00
FG 78/HSS121	121	4.3/4"	40	70	35	45	95	95	36,10
FG 78/HSS127	127	5"	40	65	30	45	90	90	37,10
FG 78/HSS133	133	5.1/4"	40	60	25	40	85	85	40,20
FG 78/HSS140	140	5.1/2"	40	60	25	40	85	85	43,30
FG 78/HSS146	146	5.3/4"	40	60	25	40	85	85	45,40
FG 78/HSS152	152	6"	40	55	25	35	75	75	49,50

ALBERO PER FRESE A TAZZA



CODICE	Per frese	L/mm	€/PZ
FG 78/AL14	16-30mm	54	19,00
FG 78/AL12	35-152mm	70	37,00

PUNTA PER CENTRARE



CODICE	Ømm	L/mm	€/PZ
FG 78/PC1	6.35	102.0	8,30

MOLLA PER FRESE A TAZZA



CODICE	L/mm	€/PZ
FG 78/SP1	40.0	2,60

PROLUNGA PER FRESE A TAZZA



CODICE	L/mm	€/PZ
FG 78/PR1	300.0	21,70

SET 9 FRESE A TAZZA IN ACCIAIO HSS BI-METAL + ACCESSORI

Fornito in ABS box



CODICE	Contenuto	€/PZ
FG 78HSS/S12	12	220,00

CONTENUTO

FG 78/HSS	19, 22, 29, 35, 38, 44, 51, 57, 64
FG 78/AL14	16-30mm
FG 78/AL12	32-152mm



SET 12 FRESE A TAZZA IN ACCIAIO HSS BI-METAL + ACCESSORI

Fornito in box di ABS

Modulo interno amovibile in gomma



CODICE	Contenuto	€/PZ
FG 78HSS/S17	17	335,00

CONTENUTO

FG 78/HSS	19, 22, 29, 35, 38, 44, 50, 51, 57, 64, 76, 83
FG 78/AL14	16-30
FG 78/AL12	35-152
FG 78/PR1	300.0
FG 78/PC1	102x6.35
FG 78/SP1	40.0

MOLA IN PIETRA CON ESTREMITÀ CONICA

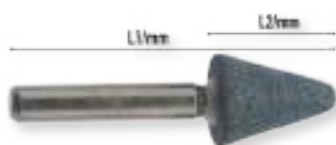

CODICE	Ømm	L2/mm	L1/mm	€/PZ
FGA 338/MO1	6.0	50	20	6,00
FGA 338/MO2	6.0	63	36	6,00

MOLA IN PIETRA CON ESTREMITÀ SFERICA



CODICE	Ømm	L2/mm	L1/mm	€/PZ
FGA 338/MO3	6.0	45	11	6,00
FGA 338/MO4	6.0	50	25	6,00

MOLA IN PIETRA CON ESTREMITÀ CILINDRICA A RAGGIO

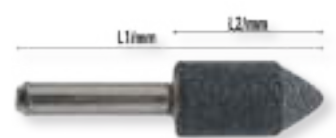

CODICE	Ømm	L2/mm	L1/mm	€/PZ
FGA 338/MO5	6.0	53	26	6,00
FGA 338/MO6	6.0	53	25	6,00
FGA 338/MO7	6.0	53	25	6,00

MOLA IN PIETRA CON ESTREMITÀ CONICA SFONDATA



CODICE	Ømm	L2/mm	L1/mm	€/PZ
FGA 338/MO10	6.0	45	15	6,00

MOLA IN PIETRA CON ESTREMITÀ A SPIGOLI VIVI



CODICE	Ømm	L2/mm	L1/mm		€/PZ
FGA 338/MO8	6.0	45	13	25	6,00
FGA 338/MO9	6.0	45	15	10	6,00

PUNTA ELICOIDALE CILINDRICA IN ACCIAIO HSS RETTIFICATO

DIN 338



CODICE	Ømm	Q.tà min.	€/PZ
FG 75/HSS0,5	0.5	10	1,90
FG 75/HSS1	1	10	1,50
FG 75/HSS1,25	1.25	10	1,50
FG 75/HSS1,5	1.5	10	1,30
FG 75/HSS1,75	1.75	10	1,30
FG 75/HSS2	2	10	1,20
FG 75/HSS2,25	2.25	10	1,40
FG 75/HSS2,5	2.5	10	1,30
FG 75/HSS2,75	2.75	10	1,90
FG 75/HSS3	3	10	1,50
FG 75/HSS3.1	3.1	10	1,70
FG 75/HSS3.2	3.2	10	1,90
FG 75/HSS3,25	3.25	10	1,70
FG 75/HSS3,5	3.5	10	1,60
FG 75/HSS3,75	3.75	10	2,00
FG 75/HSS4	4	10	1,80
FG 75/HSS4.1	4.1	10	2,10
FG 75/HSS4,2	4.2	10	2,10
FG 75/HSS4,25	4.25	10	2,20
FG 75/HSS4,5	4.5	10	2,00
FG 75/HSS4,75	4.75	10	2,40
FG 75/HSS5	5	10	2,10
FG 75/HSS5,1	5.1	10	2,80
FG 75/HSS5,25	5.25	10	3,10
FG 75/HSS5,5	5.5	10	2,80
FG 75/HSS5,75	5.75	10	3,30
FG 75/HSS6	6	10	2,90
FG 75/HSS6,25	6.25	10	4,00
FG 75/HSS6,5	6.5	10	3,70
FG 75/HSS6,75	6.75	10	4,40
FG 75/HSS7	7	10	4,80
FG 75/HSS7,5	7.5	10	4,40
FG 75/HSS8	8	10	5,30
FG 75/HSS8,5	8.5	10	6,40
FG 75/HSS9	9	10	6,70
FG 75/HSS9,5	9.5	10	7,00
FG 75/HSS10	10	10	7,80
FG 75/HSS10,5	10.5	10	9,30
FG 75/HSS11	11	10	11,40
FG 75/HSS11,5	11.5	10	11,90
FG 75/HSS12	12	10	12,90
FG 75/HSS12,5	12.5	05	14,00
FG 75/HSS13	13	05	15,00
FG 75/HSS14	14	05	22,70
FG 75/HSS15	15	05	27,90
FG 75/HSS16	16	05	32,00
FG 75/HSS17		04	38,20
FG 75/HSS18	18	04	45,40
FG 75/HSS19	19	04	48,50
FG 75/HSS20	20	04	55,70

SET 25 PUNTE ELICOIDALI CILINDRICHE IN ACCIAIO HSS RETTIFICATE

DIN 338

Fornito in box di ABS dotato di gancio di appendimento



CODICE	Ømm	€/PZ
FG 75HSS/S25	1-13mm	140,00

SET 25 PUNTE ELICOIDALI CILINDRICHE IN ACCIAIO HSS RULLATE

DIN 338

Fornito in box di ABS dotato di gancio di appendimento



CODICE	Ømm	€/PZ
FG 75/S25	1-13mm	78,00

SET 170 PUNTE ELICOIDALI CILINDRICHE IN ACCIAIO HSS - VERSIONE RULLATA



CODICE	Ømm	€/PZ
FG 75/S170	1-10mm	258,00

PUNTA ELICOIDALE CILINDRICA IN ACCIAIO HSS RETTIFICATO

DIN 338



CODICE	Ømm	Q.tà min.	€/PZ
FG 76/HSS14	14.0	05	22,70
FG 76/HSS15	15.0	05	26,80
FG 76/HSS16	16.0	05	29,90
FG 76/HSS17	17.0	04	35,10
FG 76/HSS18	18.0	04	41,20
FG 76/HSS19	19.0	04	43,30
FG 76/HSS20	20.0	04	49,50

PUNTA ELICOIDALE CILINDRICA IN ACCIAIO HSS -TIN 5% RETTIFICATO

DIN 338



CODICE	Ømm	Q.tà min.	€/PZ
FG 75/TIN0,5	0.5	10	1,80
FG 75/TIN1	1.0	10	1,80
FG 75/TIN1,5	1.5	10	1,50
FG 75/TIN2	2	10	1,70
FG 75/TIN2,5	2.5	10	1,80
FG 75/TIN3	3	10	2,20
FG 75/TIN3,5	3.5	10	2,40
FG 75/TIN4	4	10	2,50
FG 75/TIN4,5	4.5	10	2,90
FG 75/TIN5	5	10	3,30
FG 75/TIN5,5	5.5	10	4,00
FG 75/TIN6	6	10	4,40
FG 75/TIN6,5	6.5	10	4,80
FG 75/TIN7	7	10	5,30
FG 75/TIN7,5	7.5	10	6,50
FG 75/TIN8	8	10	7,60
FG 75/TIN8,5	8.5	10	9,30
FG 75/TIN9	9	10	10,10
FG 75/TIN9,5	9.5	10	11,40
FG 75/TIN10	10	10	11,70
FG 75/TIN10,5	10.5	10	13,00
FG 75/TIN11	11	10	14,00
FG 75/TIN11,5	11.5	10	15,30
FG 75/TIN12	12	05	16,00
FG 75/TIN12,5	12.5	05	17,60
FG 75/TIN13	13	05	19,60



SET

**SET PUNTE ELICOIDALI CILINDRICHE IN ACCIAIO HSS-TIN 5%
RETTIFICATO**

DIN 338

Fornito in box di ABS dotato di gancio di appendamento

CODICE	Pz	Contenuto	€/PZ
FG 75TIN/S13	13	1-6.5x0.5mm	59,00
FG 75TIN/S19	19	1-10x0.5mm	95,00
FG 75TIN/S25	25	1-13x0.5mm	198,00

**PUNTA ELICOIDALE CILINDRICA IN ACCIAIO HSS
-COBALTO 5% RETTIFICATO**

DIN 338



CODICE	Ømm	Q.tà min.	€/PZ
FG 75/CO0,5	0.5	10	4,20
FG 75/CO1	1.0	10	2,80
FG 75/CO1,5	1.5	10	2,80
FG 75/CO2	2	10	2,80
FG 75/CO2,5	2.5	10	2,90
FG 75/CO3	3	10	2,90
FG 75/CO3,5	3.5	10	3,80
FG 75/CO4	4	10	4,40
FG 75/CO4,5	4.5	10	5,10
FG 75/CO5	5	10	5,20
FG 75/CO5,5	5.5	10	7,00
FG 75/CO6	6	10	7,50
FG 75/CO6,5	6.5	10	8,80
FG 75/CO7	7	10	10,70
FG 75/CO7,5	7.5	10	12,70
FG 75/CO8	8	10	13,70
FG 75/CO8,5	8.5	10	14,50
FG 75/CO9	9	10	18,10
FG 75/CO9,5	9.5	10	19,50
FG 75/CO10	10	10	22,20
FG 75/CO10,5	10.5	10	25,80
FG 75/CO11	11	10	28,90
FG 75/CO11,5	11.5	10	30,90
FG 75/CO12	12	05	34,60
FG 75/CO12,5	12.5	05	37,10
FG 75/CO13	13	05	41,20

SET

**SET PUNTE ELICOIDALI CILINDRICHE IN ACCIAIO HSS-COBALTO
5% RETTIFICATO**

DIN 338

Fornito in box di ABS dotato di gancio di appendamento

CODICE	Pz	Contenuto	€/PZ
FG 75CO/S19	19	1-10x0.5mm	113,00
FG 75CO/S25	25	1-13x0.5mm	236,00

MINI TAGLIATUBI PER RAME E LEGHE LEGGERE

CODICE	Ømm	€/PZ
FG 76/R1	3-16	15,50

TAGLIATUBI PER RAME E LEGHE LEGGERE

CODICE	Ømm	L/mm	€/PZ
FG 76/R3	3-35	160	41,00

TAGLIATUBI PER RAME E LEGHE LEGGERE



CODICE	Ømm	L/mm	€/PZ
FG 76/R2	3-32	135	25,00

TAGLIATUBI A CRICCO PER RAME E LEGHE LEGGERE



CODICE	Ømm	L/mm	€/PZ
FG 76/R4	6-23	180	38,00

TRONCATUBI A CRICCO

Per tubi in PVC



CODICE	Ømm	€/PZ
FG 77/PVC1	0-35	35,00

PINZA REGOLABILE AUTOBLOCCANTE PER TAGLIO TUBI IN ACCIAIO



CODICE	Ømm max	€/PZ
FG 69/PC	90	85,00

TRONCATUBI A CRICCO



CODICE	Ømm	€/PZ
FG 77/PVC5	0-43	56,00

TRONCATUBI A CRICCO

Sistema a cremagliera con avanzamento progressivo
Dotata di piattaforma in nylon che facilita il taglio di profili piatti
Per tubi in PVC



CODICE	Ømm	€/PZ
FG 77/PVC4	0-42	70,00

LAMA DI RICAMBIO

CODICE	€/PZ
FG 77/PVC4-R	30,00





FASANO
TOOLS

08

ESTRATTORI



ESTRATTORE UNIVERSALE A 2 GRIFFE

Griffe scorrevoli in acciaio al cromo vanadio con sistema di bloccaggio a vite
Presa esterna
Vite in acciaio al cromo vanadio



CODICE	A/mm	H/griffa mm	€/PZ
FG 162/1	15-85	100	93,00
FG 162/2	15-125	100	98,00
FG 162/3	20-160	150	173,50
FG 162/4	20-200	150	201,00
FG 162/5	40-250	200	304,00

SET**SET 3 ESTRATTORI UNIVERSALI A 2 GRIFFE**

CODICE	Contenuto	€/PZ
FG 162/S3	FG 162/1, FG 162/2, FG 162/3	366,00

GRIFFA DI RICAMBIO PER ESTRATTORI FG 162/1 - FG 162/5

CODICE	Per	€/PZ
FG 162/1-G1	FG 162/1	28,00
FG 162/2-G2	FG 162/2	29,00
FG 162/3-G3	FG 162/3	50,00
FG 162/4-G4	FG 162/4	52,00
FG 162/5-G5	FG 162/5	70,00

VITE CENTRALE DI RICAMBIO PER ESTRATTORI FG 162/1 - FG 162/5

CODICE	Per	€/PZ
FG 162/1-V1	FG 162/1	26,00
FG 162/2-V2	FG 162/2	26,00
FG 162/3-V3	FG 162/3	32,00
FG 162/4-V4	FG 162/4	32,00
FG 162/5-V5	FG 162/5	42,00

ESTRATTORE UNIVERSALE A 2 GRIFFE SOTTILI

Griffe intercambiabili super sottili da 2mm in acciaio al cromo vanadio
Presa interna ed esterna
Vite in acciaio al cromo vanadio

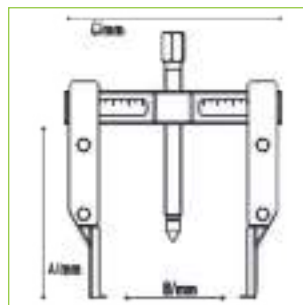

CODICE	A/mm	B/mm	C/mm	€/PZ
FG 168/EF1	110	140	186	319,50
FG 168/EF2	195	140	186	330,00

GRIFFA DI RICAMBIO PER FG 168/EF1 ED FG 168/EF2

CODICE	Per	€/PZ
FG 168/EF1-G1	FG 168/EF1	110,00
FG 168/EF2-G2	FG 168/EF2	115,00

VITE CENTRALE DI RICAMBIO PER FG 168/EF1 ED FG 168/EF2

CODICE	Per	€/PZ
FG 168/EF1-V1	FG 168/EF1	52,00
FG 168/EF2-V2	FG 168/EF2	62,00

ESTRATTORE A 2 GRIFFE OSCILLANTI

Griffe regolabili in acciaio al cromo vanadio
Vite in acciaio al cromo vanadio



CODICE	A/mm	H/mm	€/PZ
FG 162/ME	60	85	33,50

ESTRATTORE UNIVERSALE A 2 GRIFFE

Modello a forbice
Griffe regolabili in acciaio al cromo vanadio
Preso esterna
Vite in acciaio al cromo vanadio

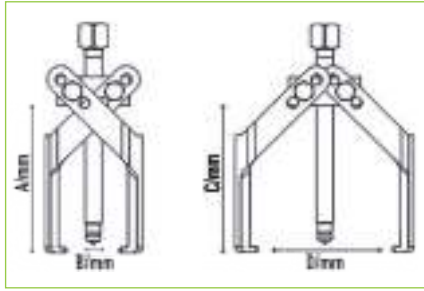

CODICE	A/mm	€/PZ
FG 162/FR1	90	149,50
FG 162/FR2	125	196,00
FG 162/FR3	125	237,00

ESTRATTORE A 3 GRIFFE AUTOREGOLABILI

Griffe autoregolabili in acciaio al cromo vanadio
Preso esterna
Vite in acciaio al cromo vanadio
Possibilità di montaggio griffe per presa interna (rif. cod. FG 164/GR)

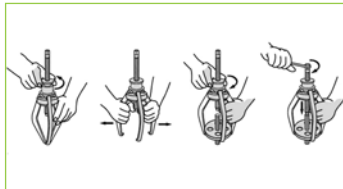

CODICE	Ø/mm	€/PZ
FG 163/1	7 - 140	201,00
FG 163/3	20 - 260	278,50

GRIFFA DI RICAMBIO PER FG 163/1 ED FG 163/3



CODICE	Per	€/PZ
FG 163/1-GR1	FG 163/1	24,00
FG 163/3-GR3	FG 163/3	33,00

VITE DI RICAMBIO PER FG 163/1 ED FG 163/3



CODICE	Per	€/PZ
FG 163/1-V1	FG 163/1	29,50
FG 163/3-V3	FG 163/3	38,50

ESTRATTORE A 3 GRIFFE AUTOREGOLABILI

Griffe autoregolabili in acciaio al cromo vanadio
Preso interna
Vite in acciaio al cromo vanadio
Possibilità di montaggio griffe per presa esterna (rif. cod. FG 163/GR)

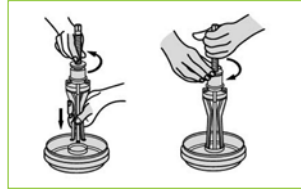

CODICE	Ø/mm	€/PZ
FG 164/1	23 - 130	196,00
FG 164/2	50 - 170	242,50

GRIFFA DI RICAMBIO PER FG 164/1 ED FG 164/2



CODICE	Per	€/PZ
FG 164/1-GR1	FG 164/1	20,00
FG 164/2-GR2	FG 164/2	25,00

VITE CENTRALE DI RICAMBIO PER FG 164/1 ED FG 164/2



CODICE	Per	€/PZ
FG 163/1-V1	FG 164/1	29,50
FG 163/3-V3	FG 164/2	38,50

SET



SET ESTRATTORE CON GRIFFE PER PRESA INTERNA ED ESTERNA

CODICE	Per	€/PZ
FG 163/S2B	7 - 140 (per presa esterna) 20 - 260 (per presa interna)	263,00



ESTRATTORE AUTOCENTRANTE A 3 GRIFFE

4 posizioni differenti

Preso esterna

Meccanismo autocentrante

Griffe con apertura per consentire una migliore presa su eventuali bulloni



CODICE	A/mm	B/mm	€/PZ
FG 165/1	120	125	298,00
FG 165/2	210	220	370,00
FG 165/3	270	280	556,00

ESTRATTORE IDRAULICO AUTOCENTRANTE A 3 GRIFFE

4 posizioni differenti

Preso esterna

Meccanismo autocentrante

Griffe con apertura per consentire una migliore presa su eventuali bulloni



CODICE	A/mm	B/mm	C/mm	€/PZ
FG 165/HI	270	280	4,5	978,00

GRIFFA DI RICAMBIO PER FG 165/1 - FG 165/3 ED FG 165/HI

CODICE	Per	€/PZ
FG 165/1-G1	FG 165/1	33,00
FG 165/2-G2	FG 165/2	44,00
FG 165/3-G3	FG 165/3	64,00

GRIFFA DI RICAMBIO PER FG 165/1 - FG 165/3 ED FG 165/HI

CODICE	Per	€/PZ
FG 165/HI-G1	FG 165/HI	64,00

VITE CENTRALE DI RICAMBIO PER FG 165/1 - FG 165/3 ED FG 165/HI

CODICE	Per	€/PZ
FG 165/1-V1	FG 165/1	25,00
FG 165/2-V2	FG 165/2	38,00
FG 165/3-V3	FG 165/3	52,00

VITE CENTRALE DI RICAMBIO PER FG 165/1 - FG 165/3 ED FG 165/HI

CODICE	Per	€/PZ
FG 165/HI-V1	FG 165/HI	360,00

ESTRATTORE MANUALE DI GRANDE POTENZA A 2 GRIFFE

Preso esterna

Le leve di supporto ad ogni griffa moltiplicano la potenza garantendo livelli di forza elevati



CODICE	Capacità	Apertura Min-Max	AxBxC/mm	HxL/mm	€/PZ
FG 160/1	2 Ton.	20 - 115mm	8x6x15	80x120	108,50
FG 160/2	5 Ton.	30 - 240mm	11x10x25	160x250	235,00
FG 160/3	10 Ton.	40 - 380mm	14x10x29	230x280	420,00

ESTRATTORE MANUALE DI GRANDE POTENZA A 3 GRIFFE

Presca esterna

Le leve di supporto ad ogni griffa moltiplicano la potenza garantendo livelli di forza elevati



CODICE	Capacità	Apertura Min-Max	AxBxC/mm	HxL/mm	€/PZ
FG 161/1	2 Ton.	28 - 112mm	8x6x15	80x120	124,00
FG 161/2	5 Ton.	40 - 243mm	11x10x25	160x250	250,00
FG 161/3	10 Ton.	46 - 370mm	14x10x29	230x280	474,00

ESTRATTORE A 3 GRIFFE PER PRESA INTERNA ED ESTERNA

Dotato di 3 griffe per presa interna e 3 griffe per presa esterna

Griffe in acciaio al cromo vanadio



CODICE	Ø interna	Ø esterna	€/PZ
FG 165/IE1	25-100mm	0-75mm	320,00
FG 165/IE2	45-150mm	40-130mm	760,00

MASSA BATTENTE

M12x1.5



CODICE	Per	€/PZ
FG 165/MB1	FG 165/IE1	170,00
FG 165/MB2	FG 165/IE2	330,00

ESTRATTORE A 2 GRIFFE OSCILLANTI

Presca esterna

Griffe in acciaio al cromo vanadio

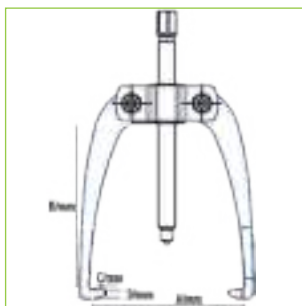

CODICE	A/mm	B/mm	C/mm	D/mm	Ton.	€/PZ
FG 160/GL1	80	80	10.7	7.90	1	88,00
FG 160/GL2	116	122	11	8.10	3	108,50
FG 160/GL3	160	161	14.2	11.1	5	165,00
FG 160/GL4	200	202	19.0	14.5	8	191,00

GRIFFA DI RICAMBIO

CODICE	Per	€/PZ
FG 160/GL1-G1	FG 160/GL1	17,00
FG 160/GL2-G2	FG 160/GL2	17,00
FG 160/GL3-G3	FG 160/GL3	30,00
FG 160/GL4-G4	FG 160/GL4	39,00

VITE CENTRALE DI RICAMBIO

CODICE	Per	€/PZ
FG 160/GL1-V1	FG 160/GL1	22,00
FG 160/GL2-V2	FG 160/GL2	35,00
FG 160/GL3-V3	FG 160/GL3	49,00
FG 160/GL4-V4	FG 160/GL4	50,00

ESTRATTORE A 3 GRIFFE OSCILLANTI

Presca esterna

Griffe in acciaio al cromo vanadio

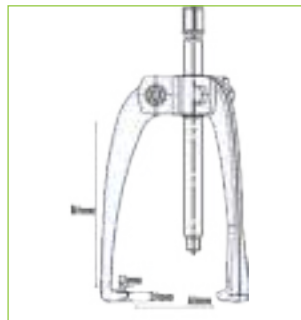

CODICE	A/mm	B/mm	C/mm	D/mm	Ton.	€/PZ
FG 161/GL1	80	80	10.7	7.90	1	108,50
FG 161/GL2	116	122	11	8.10	3	134,00
FG 161/GL3	160	161	14.2	11.1	5	206,00
FG 161/GL4	200	202	19.0	14.5	8	247,50

GRIFFA DI RICAMBIO

CODICE	Per	€/PZ
FG 160/GL1-G1	FG 161/GL1	17,00
FG 160/GL2-G2	FG 161/GL2	17,00
FG 160/GL3-G3	FG 161/GL3	30,00
FG 160/GL4-G4	FG 161/GL4	39,00

VITE CENTRALE DI RICAMBIO

CODICE	Per	€/PZ
FG 160/GL1-V1	FG 161/GL1	22,00
FG 160/GL2-V2	FG 161/GL2	35,00
FG 160/GL3-V3	FG 161/GL3	49,00
FG 160/GL4-V4	FG 161/GL4	50,00



ESTRATTORE A 2 GRIFFE OSCILLANTI

Presca esterna

Griffe in acciaio al cromo vanadio

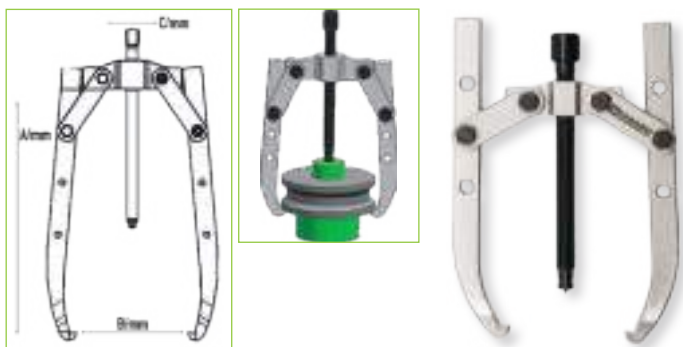

CODICE	A/mm	B/mm	C/mm	€/PZ
FG 160/OS1	105	110	70	95,00
FG 160/OS2	185	175	80	139,50
FG 160/OS3	225	240	113	211,50
FG 160/OS4	225	290	160	232,00
FG 160/OS5	400	350	161	402,00

GRIFFA DI RICAMBIO

CODICE	Per	€/PZ
FG 160/OS1-G1	FG 160/OS1	17,00
FG 160/OS2-G2	FG 160/OS2	30,00
FG 160/OS3-G3	FG 160/OS3	44,00
FG 160/OS4-G4	FG 160/OS4	46,00
FG 160/OS5-G5	FG 160/OS5	92,00

VITE CENTRALE DI RICAMBIO

CODICE	Per	€/PZ
FG 160/OS1-V1	FG 160/OS1	24,00
FG 160/OS2-V2	FG 160/OS2	38,00
FG 160/OS3-V3	FG 160/OS3	56,00
FG 160/OS4-V4	FG 160/OS4	70,00
FG 160/OS5-V5	FG 160/OS5	85,00

ESTRATTORE A 3 GRIFFE OSCILLANTI

Presca esterna

Griffe in acciaio al cromo vanadio

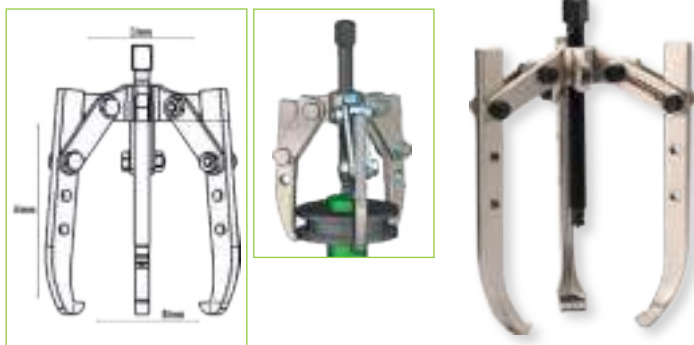

CODICE	A/mm	B/mm	C/mm	€/PZ
FG 161/OS1	105	110	80	144,50
FG 161/OS2	185	175	104	216,50
FG 161/OS3	225	240	108	294,00
FG 161/OS4	225	290	160	324,50
FG 161/OS5	400	350	161	644,00

GRIFFA DI RICAMBIO

CODICE	Per	€/PZ
FG 160/OS1-G1	FG 161/OS1	17,00
FG 160/OS2-G2	FG 161/OS2	30,00
FG 160/OS3-G3	FG 161/OS3	44,00
FG 160/OS4-G4	FG 161/OS4	46,00
FG 160/OS5-G5	FG 161/OS5	92,00

VITE CENTRALE DI RICAMBIO

CODICE	Per	€/PZ
FG 160/OS1-V1	FG 161/OS1	24,00
FG 160/OS2-V2	FG 161/OS2	38,00
FG 160/OS3-V3	FG 161/OS3	56,00
FG 160/OS4-V4	FG 161/OS4	70,00
FG 160/OS5-V5	FG 161/OS5	85,00

MARTINETTO IDRAULICO

Sistema di ritorno manuale

5 alzate

Capacità 9 Ton

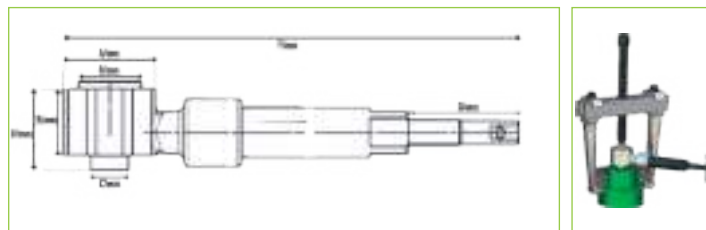

CODICE	A/mm	B/mm	C/mm	D/mm	E/mm	F/mm	G/mm	€/PZ
FG 162/MA1	48	34	20	43	35	238	58	330,00

MARTINETTO IDRAULICO

Sistema di ritorno automatico

2 alzate

Capacità 11 Ton

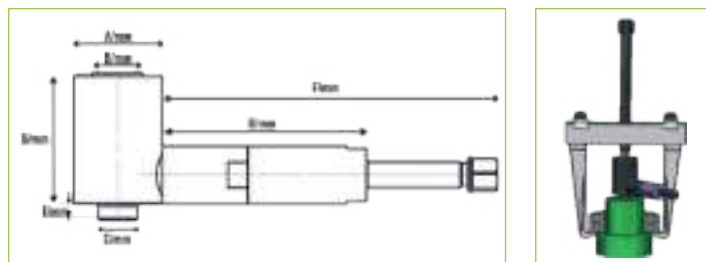

CODICE	A/mm	B/mm	C/mm	D/mm	E/mm	F/mm	G/mm	€/PZ
FG 162/MA3	70	25	28	82	12	170	103	525,50

SEPARATORI



CODICE	Ø/mm	L/mm	€/PZ
FG 166/1	5 - 50	60	72,50
FG 166/2	15 - 110	110	134,00
FG 166/3	15 - 150	150	227,00

TIRANTI

Accoppiamenti Tirante - Separatore:

FG 167/2 - FG166/1

FG 167/3 - FG 166/2

FG 167/4 - FG 166/3



CODICE	Ø/mm	L/mm	€/PZ
FG 167/1	25 - 95	90	64,00
FG 167/2	40 - 120	180	105,50
FG 167/3	75 - 190	245	227,00
FG 167/4	80 - 280	300	390,00

ESPANSORE A SETTORE PER INTERNI

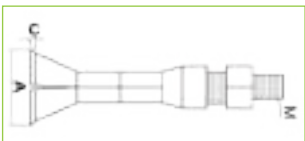

CODICE	A/mm	M	C/mm	€/PZ
FG 182/ES1	8.6-9.6	M10	1.5	48,50
FG 182/ES2	13-18	M10	1.5	60,00
FG 182/ES3	21-23	M10	1.5	62,00
FG 182/ES4	25-29	M10	1.5	64,00
FG 182/ES5	27-33	M10	2.5	98,00
FG 182/ES6	36.5-37	M10	3.5	101,00
FG 182/ES7	43-51	M16	3.5	122,00

ESTRATTORE PER ESPANSORE



CODICE	Ø/mm	M	L/mm	€/PZ
FG 182/EG1	35-7	M10	140140	79,50
FG 182/EG2	60-140	M16	160	122,00

SET



SET ESPANSORI A SETTORE PER INTERNI CON ACCESSORI

CODICE	Contenuto	€/PZ
FG 182/S10	FG 182/ES1 FG 182/ES7 FG 182/EG1 FG 182/EG2 FG 182/MI	875,00



SET ESPANSORI A SETTORE PER INTERNI CON ACCESSORI

CODICE	Contenuto	€/PZ
FG 182/S5B	FG 182/EG1 FG 182/ES1 FG 182/ES2 FG 182/ES3 FG 182/ES4 FG 182/ES5	475,00





SET ESTRATTORI PER CUSCINETTI CON FALSE SFERE

Fornito in box di ABS

CODICE	Contenuto Ø/mm	€/PZ
FG 182/S14	5,6,8,9,11,12,5	238,00

ESTRATTORE A PERCUSSIONE



CODICE	L/mm	M	€/PZ
FG 182/MI	390	10	80,00

ESTRATTORI A RULLI PER VITI PRIGIONIERI

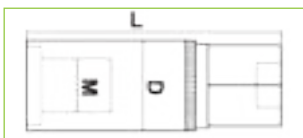

CODICE	M	■ - ●	L/mm	€/PZ
FG 168/R6	6	1/4"-21mm	60	13,50
FG 168/R7	7	1/4"-21mm	60	13,50
FG 168/R8	8	1/4"-21mm	60	14,50
FG 168/R9	9	1/4"-21mm	69	15,50
FG 168/R10	10	1/4"-21mm	69	15,50
FG 168/R10.5	10.5	1/4"-21mm	69	15,50
FG 168/R12	12	1/4"-21mm	69	15,50
FG 168/R14	14	-24mm	73	22,00
FG 168/R16	16	-24mm	73	23,00

SET



SET 9 ESTRATTORI A RULLI PER VITI PRIGIONIERE

CODICE	Contenuto	€/PZ
FG 168/S9	FG 168/R6 - R16	180,00

ESTRATTORE CONICO PER VITI E PRIGIONIERI SPEZZATI



CODICE	Ø/mm	A/mm	€/PZ
FG 168/F1	3-6	2.5	3,00
FG 168/F2	6-8	3.0	3,00
FG 168/F3	8-11	4.5	4,50
FG 168/F4	11-14	6.0	5,00
FG 168/F5	14-18	8.0	5,50
FG 168/F6	18-24	11.0	7,50
FG 168/F7	24-33	14.0	13,50
FG 168/F8	33-50	21.0	19,00

SET



SET ESTRATTORI CONICI PER VITI E PRIGIONIERI SPEZZATI

CODICE	Contenuto	€/PZ
FG 168/FS5	FG 168/F1 - F5	19,50
FG 168/FS8	FG 168/F1 - F8	62,00



SET 5 ESTRATTORI CONICI PER VITI E PRIGIONIERI SPEZZATI

Inserimento a percussione

CODICE	Ø/mm	€/PZ
FG 168EP/S5	3 - 9	33,00



SET ESTRATTORI PER VITI E PRIGIONIERI SPEZZATI

Dotato di guide per interno ed esterno e punte per forare
Utilizzo: viti/bulloni con diametro 6-16mm

CODICE	€/PZ
FG 168/S25	144,00

SPACCADADI



CODICE	ØMax	L/mm	€/PZ
FG 168/SD1	12mm	62	19,00
FG 168/SD2	17mm	82	25,00
FG 168/SD3	22mm	106	34,00
FG 168/SD4	35mm	125	46,50

SET



SET 4 SPACCADADI

Fornito in box di ABS

CODICE	Contenuto	€/PZ
FG 168SD/S4	FG 164/SD1 - SD4	155,00

ESTRATTORE AD ESPANSIONE



CODICE	Ø/mm	L1/mm	L2/mm	€/PZ
FG 182/TS1	29-44	51	132	31,00
FG 182/TS2	38-64	64	164	43,00
FG 182/TS3	54-89	77	215	75,00

ESTRATTORE PER DADI DESTROSI DANNEGGIATI CON ATTACCO 1/2"

Finitura brunita

NEW



CODICE	Ø/mm	L/mm	€/PZ
FG 168/A8	8	33	14,70
FG 168/A9	9	33	14,70
FG 168/A10	10	33	14,70
FG 168/A11	11	33	14,70
FG 168/A12	12	33	14,70
FG 168/A13	13	35	14,70
FG 168/A14	14	35	15,50
FG 168/A15	15	35	15,50
FG 168/A16	16	35	15,50
FG 168/A17	17	35	15,50
FG 168/A18	18	35	16,00
FG 168/A19	19	35	16,00
FG 168/A21	21	35	17,00
FG 168/A22	22	35	17,00
FG 168/A24	24	35	17,60
FG 168/A27	27	35	19,30
FG 168/A30	30	39	24,70
FG 168/A32	32	39	24,70

SET



SET ESTRATTORI PER DADI DESTROSI DANNEGGIATI CON ATTACCO 1/2"

Fornito su supporto in ABS appendibile con ganci a clip e meccanismo finecorsa anticaduta

NEW

CODICE	Pz	Contenuto	€/PZ
FG 168A/S5	5	22, 24, 27, 30, 32 mm	110,00
FG 168A/S13	13	8, 9, 10, 11, 12, 13, 14, 15, 16, 17, 18, 19, 21 mm	210,00





5 M x 25MM
FASANO
TOOLS
FS 4MMTS

—
09
—

STRUMENTI DI MISURAZIONE



FASANO

FLESSOMETRO CON CASSA IN ABS ANTI-SHOCK E NASTRO IN ACCIAIO RIVESTITO IN NYLON

CLASSE II



SCEGLI LA BANDA ADATTA ALLE TUE ESIGENZE:

Blade width	Horizontal stand-out	Vertical stand-out	Back side Vertical stand-out
16mm	1.5m	2.1m	
19mm	1.8m	2.6m	3.5m
25mm	2.3m	3.6m	5.8m
27mm	2.9m	4.6m	6.8m

BANDA INTERAMENTE RIVESTITA IN NYLON CON UN PROCESSO CHE GARANTISCE MIGLIORI PRESTAZIONI IN TERMINI DI RESISTENZA ALL' ABRASIONE, ALLA CORROSIONE E ALLA DURATA NEL TEMPO

MECCANISMO DI ARRESTO DELLA BANDA AUTOMATICO

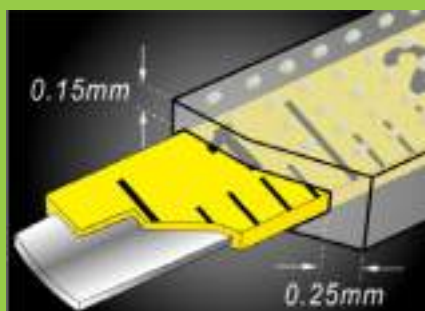

FLESSOMETRO CON CASSA IN ABS ANTI-SHOCK E NASTRO IN ACCIAIO RIVESTITO IN NYLON

Classe II



CODICE	L/mt	Banda mm	€/PZ
FG 44/MT3	3	16	11,50
FG 44/MT5	5	25	18,00
FG 44/MT8	8	25	24,00
FG 44/MT10	10	25	29,00

FLESSOMETRO CON CASSA IN ABS E NASTRO IN ACCIAIO RIVESTITO IN NYLON

Classe II



CODICE	L/mt	Banda mm	€/PZ
FG 43/MT3	3	16	7,30
FG 43/MT5	5	19	9,30

ROTELLA METRICA CON CASSA IN ABS IN FIBRA DI VETRO

Classe III



CODICE	L/mt	€/PZ
FG 45/MT10	10	11,00
FG 45/MT20	20	12,00

METRO IN FIBRA DI VETRO 2MT

Classe III

Graduazione incisa

Snodi con doppia molla antiusura

Scatto a 90°

Non conduttore e lavabile



CODICE	L/mt	€/PZ
FG 46/FR2	2	7,00

SQUADRA SEMPLICE IN ACCIAIO ZINCATO NORMALIZZATO

DIN 875/0



CODICE	L/mm	€/PZ
FG 81/S1	100x70	18,50
FG 81/S2	150x100	24,00
FG 81/S3	200x130	28,50
FG 81/S4	250x165	33,00
FG 81/S5	300x200	39,50

SQUADRA A CAPPELLO IN ACCIAIO ZINCATO NORMALIZZATO

DIN 875/0



CODICE	L/mm	€/PZ
FG 81/C1	100x70	21,00
FG 81/C2	150x100	30,00
FG 81/C3	200x130	35,00
FG 81/C4	250x165	42,00
FG 81/C5	300x200	50,00

LIVELLA CON BASE MAGNETICA A 3 FIALE INFRANGIBILI



CODICE	L/mm	€/PZ
FG 94/300	300	28,00
FG 94/600	600	38,00
FG 94/800	800	54,00
FG 94/1000	1000	70,00

PUNTA PER TRACCIARE IN METALLO DURO



CODICE	L/mm	€/PZ
FG 81/PT1	150	24,00



PUNTA PER TRACCIARE IN ACCIAIO TEMPRATO BRUNITO

CODICE	L/mm	€/PZ
FG 81/PT2	190	9,50

MATITA PER FALEGNAME

CODICE	L/mm	€/PZ
FG 81/MS	190	0,70

CONTAFILETTI

Metrico: 0.4 ÷ 6.0



CODICE	€/PZ
FG 95/CF	16,00

FASANO
TOOLS
CALIBRO A CORSOIO, LETTURA CINQUANTESIMALEScala cromata
Asta sottile
Bloccaggio a vite

CODICE	L/mm	€/PZ
FG 95/CA	150	52,00

CALIBRO A CORSOIO, LETTURA CINQUANTESIMALEScala cromata
Asta sottile
Bloccaggio a vite
Inox temprato

CODICE	L/mm	€/PZ
FG 95/CA2	200	125,00

CALIBRO DI PROFONDITÀ, LETTURA CINQUANTESIMALEScala cromata
Asta sottile
Bloccaggio a vite
Inox temprato

CODICE	L/mm	€/PZ
FG 95/CP1	200	96,00

CALIBRO A CORSOIO DIGITALE, LETTURA CINQUANTESIMALE

CODICE	L/mm	€/PZ
FG 95/DG	155	95,00

GONIOMETRI SEMPLICI

Scala di lettura antiriflesso
Bloccaggio a vite
Risoluzione 1°



CODICE	L/mm	Scala	€/PZ
FG 95/G01	120	0-180°	72,50
FG 95/G02	150	0-180°	89,00
FG 95/G03	200	0-180°	105,00

MICROMETRI CENTESIMALI PER ESTERNI

Contatti in metallo duro
Stelo Ø 6,5mm
Arco cromato



CODICE	Ø/mm	Risoluzione	€/PZ
FG 95/M1	0-25	0,01	58,00
FG 95/M2	25-50	0,01	62,00
FG 95/M3	50-75	0,01	72,00
FG 95/M4	75-100	0,01	89,00

COMPARATORE CENTESIMALE

Asta a cremagliera in acciaio Inox temprato
Quadrante girevole con indici di tolleranza regolabili
Vite superiore per azzeramenti manuali



CODICE	Ø/mm	L1/mm	L2/mm	€/PZ
FG 95/CO	2.5	40	58	110,00

SUPPORTO MAGNETICO PER COMPARATORI

Forza magnetica di adesione: 600N
Attacco per comparatore Ø 6-8mm
Lunghezza asta girevole: 150mm



CODICE	€/PZ
FG 95/BA	75,00

TERMOMETRO DIGITALE A INFRAROSSI

Scala °C/°F
Potenza laser 1mW
Risposta 0.5 sec
Emissività 0.1 ~ 1.0 regolabile
Rapporto di distanza 12:1
Temperatura operativa 0°C ~ 75°C
Umidità operativa: 0% ~ 90% RH
Display LCD retroilluminato
Funzione memoria fino a 10 diverse memorizzazioni
Autospegnimento dopo 6 secondi
1 batteria 9V inclusa
Custodia morbida in nylon



CODICE	Range	Dimensione mm e peso kg	€/PZ
FG 97/T1	-32°C ~ 760°C / -25°F ~ 1.400°F		250,00
FG 97/T2	-32°C ~ 1650°C / -25°F ~ 3002°F	200x166x51 - 280	450,00





10

UTENSILI PNEUMATICI



FASANO
TOOLS

AVVITATORE AD IMPULSI 1/2"

Regolatore di potenza integrato dietro al tasto d'avvio
 Dotato di gancio di appendimento
 Impugnatura ergonomica
 Protezione anti-urto della cassa superiore
 Attacco aria 1/4" gas
 Ø interno tubo aria 10mm (3/8")



CODICE	Nm MAX	Forza torcente	RPM	Bar	gr	L/min	€/PZ
FGA 307	1085	746/610	9.500	6.2	1200	136	250,00

KIT



KIT MANUTENZIONE BASE PER FGA 307

CODICE	€/PZ
FGA 307/KIT	30,00

AVVITATORE AD IMPULSI 1/2"

Regolatore di potenza integrato dietro al tasto d'avvio
 Dotato di gancio di appendimento
 Impugnatura ergonomica
 Protezione anti-urto della cassa superiore
 Attacco aria 1/4" gas
 Ø interno tubo aria 10mm (3/8")

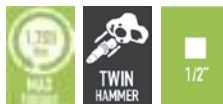

CODICE	Nm MAX	Forza torcente	RPM	Bar	gr	L/min	€/PZ
FGA 309	1700	1085/746	7300	6.2	1900	151	300,00

KIT



KIT MANUTENZIONE BASE PER FGA 309

CODICE	€/PZ
FGA 309/KIT	45,00

SET



SET AVVITATORE 1/2" FGA 309 + 03 BUSSOLE RINFORZATE X CERCHI IN LEGA LEGGERA



CODICE	Contenuto	€/PZ
FGA 309/S4	FGA 309 FGA 628/R17, 19, 21	385,00



SET AVVITATORE 1/2" FGA 309 + 9 BUSSOLE RINFORZATE CORTE 1/2"



CODICE	Contenuto	€/PZ
FGA 309/S10	FGA 309 FG 628/C10, 11, 13, 14, 17, 19, 22, 24, 27	395,00

AVVITATORE AD IMPULSI 1/2"

Regolatore di potenza integrato dietro al tasto d'avvio
 Dotato di gancio di appendimento
 Impugnatura ergonomica
 Protezione anti-urto della cassa superiore
 Attacco aria 1/4" gas
 Ø interno tubo aria 10mm (3/8")

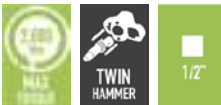

CODICE	Nm MAX	Forza torcente	RPM	Bar	gr	L/min	€/PZ
FGA 312	2000	1130/950	7500	6.2	2000	136	380,00

KIT



KIT MANUTENZIONE BASE PER FGA 312

CODICE	€/PZ
FGA 312/KIT	45,00

AVVITATORE AD IMPULSI-1/2"

Regolatore di potenza integrato dietro al tasto d'avvio
 Dotato di gancio di appendimento
 Impugnatura ergonomica
 Protezione anti-urto della cassa superiore
 Attacco aria 1/4" gas
 Ø interno tubo aria 10mm (3/8")



CODICE	Forza torcente	RPM	Bar	gr	L/min	€/PZ
FGA 302	880/745	7800	6.2	2100	127	240,00

KIT



KIT MANUTENZIONE BASE PER FGA 302

CODICE	€/PZ
FGA 302/KIT	30,00

SET



SET AVVITATORE 1/2" FGA 302 + 03 BUSSOLE RINFORZATE X CERCHI IN LEGA LEGGERA



CODICE	Contenuto	€/PZ
FGA 302/S4	FGA 302 FG 628/R17, 19, 21	295,00



SET AVVITATORE 1/2" FGA 302 + 9 BUSSOLE RINFORZATE CORTE 1/2"



CODICE	Contenuto	€/PZ
FGA 302/S10	FGA 302 FG 628/C10, 11, 13, 14, 17, 19, 22, 24, 27	340,00



AVVITATORE AD IMPULSI DA 3/4"

Meccanismo a doppia massa battente
Sistema di reversibilità posteriore a rotazione
Inversione velocità con sistema a pulsanti
Impugnatura ergonomica in PVC anti-scivolo
Attacco aria 3/8" gas
Ø interno tubo aria 13mm (1/2")

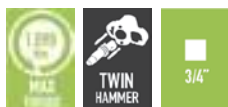

CODICE	Nm MAX	Forza torcente	RPM	Bar	gr	L/min	€/PZ
FGA 316	1898	1898/1627	5300	6.2	3300	229	760,00

AVVITATORE AD IMPULSI - 3/4" AD ALBERO LUNGO 6"

Meccanismo a doppia massa battente
Sistema di reversibilità posteriore a rotazione
Inversione velocità con sistema a pulsanti
Impugnatura ergonomica in PVC anti-scivolo
Attacco aria 3/8" gas
Ø interno tubo aria 13mm (1/2")

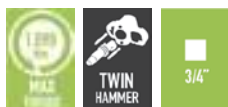

CODICE	Nm MAX	Forza torcente	RPM	Bar	gr	L/min	€/PZ
FGA 316/L	1898	1898/1627	5300	6.2	3300	229	830,00

KIT



KIT MANUTENZIONE FGA 316-FGA 316/L

CODICE	€/PZ
FGA 316/KIT	100,00

AVVITATORE AD IMPULSI - 1"

Impugnatura laterale amovibile
Attacco aria 1/2" gas
Ø interno tubo aria 19mm (3/4")



CODICE	Forza torcente	RPM	Bar	gr	L/min	€/PZ
FGA 319	2700/2500	4800	6.2	10200	271	1.150,00

AVVITATORE AD IMPULSI 1" AD ALBERO LUNGO 6"

Impugnatura laterale amovibile
Attacco aria 1/2" gas
Ø interno tubo aria 19mm (3/4")



CODICE	Forza torcente	RPM	Bar	gr	L/min	€/PZ
FGA 319/L	2700/2500	4800	6.2	10200	271	1.250,00

KIT



KIT MANUTENZIONE BASE PER FGA 319 E FGA 319/L

CODICE	€/PZ
FGA 319/KIT	100,00

AVVITATORE AD IMPULSI 1"

Meccanismo doppio martello
Impugnatura rivestita in PVC anti-scivolo
Scarico dell'aria verso il basso
Impugnatura laterale amovibile
Doppio ingresso aria
Attacco aria 1/2" gas
Ø interno tubo aria 19mm (3/4")



CODICE	Nm MAX	Forza torcente	RPM	Bar	gr	L/min	€/PZ
FGA 321	2983	2576/	5500	6.2	6800	340	1.050,00

AVVITATORE AD IMPULSI 1" AD ALBERO LUNGO 6"

Meccanismo doppio martello
Impugnatura rivestita in PVC anti-scivolo
Scarico dell'aria verso il basso
Dotato di impugnatura laterale amovibile
Doppio ingresso aria
Attacco aria 1/2" gas
Ø interno tubo aria 19mm (3/4")



CODICE	Nm MAX	Forza torcente	RPM	Bar	gr	L/min	€/PZ
FGA 321/B	2983	2576/	5500	6.2	6800	340	1.100,00

KIT



KIT MANUTENZIONE BASE PER FGA 321 E FGA 321/B

CODICE	€/PZ
FGA 321B/KIT	220,00

AVVITATORE AD IMPULSI 1" AD ALBERO LUNGO 6"

Impugnatura rivestita in PVC anti-scivolo
Scarico dell'aria verso il basso
Dotato di impugnatura laterale amovibile
Attacco aria 1/2" gas
Ø interno tubo aria 13mm (1/2")



CODICE	Forza torcente	RPM	Bar	gr	L/min	€/PZ
FGA 321/C	2700/2500	4800	6.2	12500	271	1.220,00

CRICCHETTO REVERSIBILE 1/4"

Sistema di reversibilità integrata sulla testa
Sistema di azionamento a pinza
Attacco aria 1/4" gas
Ø interno tubo aria 10mm (3/8")



CODICE	Nm MAX	RPM	Bar	gr	L/min	L/mm	€/PZ
FGA 290	40	280	6.2	730	68	165	192,00

KIT



KIT MANUTENZIONE BASE PER FGA 290

CODICE	€/PZ
FGA 290/KIT	20,00



CRICCHETTO REVERSIBILE DA 3/8"

Sistema di reversibilità integrata sulla testa

Sistema di azionamento a pinza

Impugnatura ricoperta in gomma termoplastica anti-scivolo

Attacco aria 1/4" gas

Ø interno tubo aria 10mm (3/8")



CODICE	Nm MAX	RPM	Bar	gr	L/min	L/mm	€/PZ
FGA 291	50	175	6.2	1200	85	265	170,00

KIT**KIT MANUTENZIONE BASE PER FGA 291**

CODICE	€/PZ
FGA 291/KIT	30,00

CRICCHETTO REVERSIBILE 1/2"

Sistema di reversibilità integrata sulla testa

Sistema di azionamento a pinza

Impugnatura ricoperta in gomma termoplastica anti-scivolo

Attacco aria 1/4" gas

Ø interno tubo aria 10mm (3/8")



CODICE	Nm MAX	RPM	Bar	gr	L/min	L/mm	€/PZ
FGA 292/B	244	300	6.2	1300	105	340	215,00

KIT**KIT MANUTENZIONE BASE PER FGA 292/B**

CODICE	€/PZ
FGA 292B/KIT	30,00

AVVITATORE AD IMPULSI DA 3/8"

Meccanismo a doppia massa battente

Sistema di reversibilità posteriore a rotazione

Corpo materiale composito con scocca anteriore in acciaio

Attacco aria 1/4" gas

Ø interno tubo aria 10mm (3/8")



CODICE	Forza torcente	RPM	Bar	gr	L/min	L/mm	€/PZ
FGA 304	475/441	9000	6.2	1280	130	166	245,00

KIT**KIT MANUTENZIONE BASE PER FGA 304**

CODICE	€/PZ
FGA 304/KIT	32,00



AVVITATORE ANGOLARE AD IMPULSI-1/2"

Corpo ultracompatto
Pulsante di avviamento
Scarico aria centrale ruotabile a 360°
Sistema di reversibilità
Doppio livello di velocità regolabile
Attacco aria 1/4" gas
Ø interno tubo aria 10mm (3/8")



CODICE	Nm MAX	Forza torcente	RPM	Bar	gr	L/min	€/PZ
FGA 307/AN	680	420/244	9000	6.2	1150	113	340,00

KIT



KIT MANUTENZIONE BASE PER FGA 307/AN

CODICE	€/PZ
FGA 307/AN/KIT	30,00

PISTOLA DI GONFIAGGIO

Corpo in alluminio nichelato
Rivestimento in gomma antiolio
Manometro Ø80 (0-10bar)
Protezione sovrappressioni
Leva a due posizioni scarico/gonfiaggio



CODICE	Lunghezza tubo mm	€/PZ
FGA 390	500	150,00

LEVIGATRICE PER PNEUMATICI

Attacco aria 1/4" gas
Ø interno tubo aria 10mm (3/8")



CODICE	RPM	Bar	gr	L/min	L/mm	€/PZ
FGA 322	2600	6.2	800	85	190	140,00

MOLA DI RICAMBIO

CODICE	€/PZ
FGA 322/R2	33,00

KIT



KIT MANUTENZIONE BASE PER FGA 322

CODICE	€/PZ
FGA 322/KIT	28,00

SEGHETTO ALTERNATIVO

Corpo in alluminio rivestito in gomma anti-scivolo
Sistema di azionamento a pinza
Sistema di regolazione lama facilmente accessibile
Protezione lama anteriore in acciaio
Attacco aria 1/4" gas
Ø interno tubo aria 10mm (3/8")



CODICE	Corse al minuto	Bar	gr	L/min	L/mm	€/PZ
FGA 330	9500	6.2	400	99	160	295,00

KIT



KIT MANUTENZIONE BASE PER FGA 330

CODICE	€/PZ
FGA 330/KIT	30,00

KIT 10 LAME DI RICAMBIO

CODICE	€/PZ
FGA 330/24T	47,00
FGA 330/32T	47,00



TRAPANO ANGOLARE MANDRINO AUTOSERRANTE 1-10MM

Sistema di azionamento a pinza con velocità graduale

Mandrino auto-serrante 1-10mm (3/8")

Dotato di sistema di reversibilità

Attacco aria 1/4" gas

Ø interno tubo aria 10mm (3/8")



CODICE	Hp	RPM	Bar	gr	L/min	€/PZ
FGA 332/AN	0.45	1800	6.2	900	60	180,00

KIT**KIT MANUTENZIONE BASE FGA 332/AN**

CODICE	€/PZ
FGA 332AN/KIT	28,00

TRAPANO REVERSIBILE CON MANDRINO AUTOSERRANTE 1-10MM

Sistema di azionamento a pulsante con velocità graduale

Mandrino auto-serrante 1-10mm (3/8")

Attacco aria 1/4" gas

Ø interno tubo aria 10mm (3/8")



CODICE	Hp	RPM	Bar	gr	L/min	L/mm	€/PZ
FGA 332	0.45	1800	6.2	900	113	160	145,00

KIT**KIT MANUTENZIONE BASE PER FGA 332**

CODICE	€/PZ
FGA 332/KIT	28,00

TRAPANO REVERSIBILE CON MANDRINO IN ACCIAIO 1-13MM

Sistema di azionamento a pulsante con velocità graduale

Mandrino auto-serrante 1-13mm (1/2")

Possibilità di applicare l'impugnatura aggiuntiva di supporto girevole a 360°

Attacco aria 1/4" gas

Ø interno tubo aria 10mm (3/8")



CODICE	Hp	RPM	Bar	gr	L/min	L/mm	€/PZ
FGA 333/AC	0.45	700	6.2	1200	113	205	210,00

TRAPANO REVERSIBILE CON MANDRINO AUTOSERRANTE 1-13MM

Sistema di azionamento a pulsante con velocità graduale

Mandrino auto-serrante 1-13mm (1/2")

Possibilità di applicare l'impugnatura aggiuntiva di supporto girevole a 360°

Attacco aria 1/4" gas

Ø interno tubo aria 10mm (3/8")



CODICE	Hp	RPM	Bar	gr	L/min	L/mm	€/PZ
FGA 333	0.45	700	6.2	1300	113	205	185,00

KIT**KIT MANUTENZIONE FGA 333-FGA 333/AC**

CODICE	€/PZ
FGA 333/KIT	28,00

LEVIGATRICE ANGOLARE - Ø DISCO: 50MM

Capacità disco: 50mm
Corpo rivestito in gomma anti-scivolo
Sistema di regolazione velocità a pinza
Attacco aria 1/4" gas
Ø interno tubo aria 10mm (3/8")



CODICE	RPM	Bar	gr	L/min	L/mm	€/PZ
FGA 339/B	1500	6.2	500	74	140	190,00

DISCHETTI

CODICE	€/PZ
FGA 339/B-G60	9,00
FGA 339/B-G80	10,00
FGA 339/B-G120	12,00

KIT



KIT MANUTENZIONE BASE FGA 339/B

CODICE	€/PZ
FGA 339B/KIT	28,00

LEVIGATRICE ANGOLARE - Ø DISCO: 115MM

Capacità disco: 115mm
Impugnatura rivestita in gomma anti-scivolo
Sistema di regolazione velocità a pinza
Possibilità di montare impugnatura aggiuntiva laterale (fornita di serie)
Attacco aria 1/4" gas
Ø interno tubo aria 10mm (3/8")



CODICE	M	RPM	Bar	gr	L/min	L/mm	€/PZ
FGA 339	14x2	11000	6.2	2000	113	225	355,00

KIT



KIT MANUTENZIONE BASE PER FGA 339

CODICE	€/PZ
FGA 339/KIT	40,00

RIVETTATRICE PNEUMATICA

4 testine intercambiabili
Dotata di serbatoio posteriore per caduta rivetti
Corpo in acciaio resistente agli urti
Attacco aria 1/4" gas
Ø interno tubo aria 10mm (3/8")
ALLUMINIO: 2.4, 3.2, 4.0, 4.8
ACCIAIO: 2.4, 3.2, 4.0, 4.8
INOX: 2.4, 3.2, 4.0



CODICE	Forza N	Corsa mm	Bar	gr	L/min	€/PZ
FGA 335	12000	14	6.2	1500	99	210,00

KIT



KIT MANUTENZIONE BASE PER FGA 335

CODICE	€/PZ
FGA 335/KIT	22,00



RIVETTATRICE PNEUMATICA

4 testine intercambiabili

Dotata di serbatoio posteriore per caduta rivetti

Corpo in acciaio resistente agli urti

Attacco aria 1/4" gas

Ø interno tubo aria 10mm (3/8")

ALLUMINIO: 3.0/3.2, 4.0, 4.8, 6.4

ACCIAIO: 3.0/3.2, 3.2, 4.0, 4.8, 6.4

INOX: 3.0/3.2, 3.2, 4.0, 4.8



CODICE	Forza N	Corsa mm	Bar	gr	L/min	€/PZ
FGA 336	13930	18	6.2	2000	148	600,00

KIT**KIT MANUTENZIONE BASE FGA 336**

CODICE	€/PZ
FGA 336/KIT	35,00

SMERIGLIATRICE DIRITTA A PINZA

Nuove lame rotore in kevlar

Testa diritta con aggancio a pinza

Impugnatura ergonomica

Corpo rivestito in gomma anti-scivolo

Sistema di regolazione velocità a pinza

Attacco aria 1/4" gas

Ø interno tubo aria 10mm (3/8")



CODICE	Hp	RPM	Bar	gr	L/min	L/mm	€/PZ
FGA 338	0.50	22000	6.2	600	99	160	125,00

KIT**KIT MANUTENZIONE BASE PER FGA 338**

CODICE	€/PZ
FGA 338/KIT	28,00

SMERIGLIATRICE DIRITTA A PINZA A BASSA VELOCITÀ

Nuove lame rotore in KEVLAR

Motore a basso numero di giri

Diametro del corpo compatto

Impugnatura ergonomica

Attacco aria 1/4" gas

Ø interno tubo aria 10mm (3/8")



CODICE	Hp	RPM	Bar	gr	L/min	L/mm	€/PZ
FGA 338/B	0.45	7600	6.2	600	74	170	160,00

KIT**KIT MANUTENZIONE BASE PER FGA 338/B**

CODICE	€/PZ
FGA 338B/KIT	35,00

SMERIGLIATRICE ANGOLARE A PINZA

Nuove lame rotore in KEVLAR

Motore ad elevata potenza

Testa angolare a 90°

Impugnatura ergonomica

Corpo rivestito in gomma anti-scivolo

Sistema di regolazione velocità a pinza

Attacco aria 1/4" gas

Ø interno tubo aria 10mm (3/8")



CODICE	Hp	RPM	Bar	gr	L/min	L/mm	€/PZ
FGA 338/AN	0.45	18000	6.2	700	60	160	170,00

KIT**KIT MANUTENZIONE BASE FGA 338/AN**

CODICE	€/PZ
FGA 338AN/KIT	28,00

SMERIGLIATRICE PINZA AD ALBERO LUNGO

Nuove lame rotore in KEVLAR
 Motore ad elevata potenza
 Albero lungo con aggancio a pinza
 Impugnatura ergonomica
 Corpo rivestito in gomma anti-scivolo
 Sistema di regolazione velocità a pinza
 Attacco aria 1/4" gas
 Ø interno tubo aria 10mm (3/8")



CODICE	Hp	RPM	Bar	gr	L/min	L/mm	€/PZ
FGA 338/L	0.45	22000	6.2	800	60	265	165,00

KIT



KIT MANUTENZIONE BASE PER FGA 338/L

CODICE	€/PZ
FGA 338L/KIT	28,00

SMERIGLIATRICE ANGOLARE A PINZA - INCLINAZIONE 115°

Palette interne in KEVLAR
 Motore ad elevato numero di giri
 Basso consumo d'aria
 Impugnatura ergonomica
 Corpo in materiale composito con speciali scanalature che ne aumentano il grip
 Testa inclinata a 115°
 Attacco aria 1/4" gas
 Ø interno tubo aria 10mm (3/8")



CODICE	Hp	RPM	Bar	gr	L/min	L/mm	€/PZ
FGA 334/AN115	0.35	22000	6.2	600	74	155	185,00

KIT



KIT MANUTENZIONE BASE FGA 334/AN115

CODICE	€/PZ
FGA 334AN115/KIT	35,00

SMERIGLIATRICE DIRITTA A PINZA

Palette interne in KEVLAR
 Motore ad elevato numero di giri
 Basso consumo d'aria
 Impugnatura ergonomica
 Corpo in materiale composito con speciali scanalature che ne aumentano il grip
 Attacco aria 1/4" gas
 Ø interno tubo aria 10mm (3/8")



CODICE	Hp	RPM	Bar	gr	L/min	L/mm	€/PZ
FGA 334	0.35	25000	6.2	400	74	155	145,00

KIT



KIT MANUTENZIONE BASE PER FGA 334

CODICE	€/PZ
FGA 334/KIT	35,00

SMERIGLIATRICE ANGOLARE A PINZA

Palette interne in KEVLAR
 Motore ad elevato numero di giri
 Basso consumo d'aria
 Impugnatura ergonomica
 Corpo in materiale composito con speciali scanalature che ne aumentano il grip
 Testa inclinata a 90°
 Attacco aria 1/4" gas
 Ø interno tubo aria 10mm (3/8")



CODICE	Hp	RPM	Bar	gr	L/min	L/mm	€/PZ
FGA 334/AN	0.35	20000	6.2	500	60	160	185,00

KIT



KIT MANUTENZIONE BASE FGA 334/AN

CODICE	€/PZ
FGA 334AN/KIT	35,00



SMERIGLIATRICE PINZA AD ALBERO LUNGO

Palette interne in KEVLAR
Motore ad elevato numero di giri
Basso consumo d'aria
Impugnatura ergonomica
Corpo in materiale composito con speciali scanalature che ne aumentano il grip
Attacco aria 1/4" gas
Ø interno tubo aria 10mm (3/8")



CE

CODICE	Hp	RPM	Bar	gr	L/min	L/mm	€/PZ
FGA 334/L	0.35	25000	6.2	700	74	265	185,00

KIT**KIT MANUTENZIONE BASE FGA 334/L**

CODICE	€/PZ
FGA 334L/KIT	35,00

MICROSMERIGLIATRICE ASSIALE

Capacità pinza: 3mm
Attacco aria 1/4" gas
Ø interno tubo aria 6.4mm (1/4")



CE

CODICE	RPM	Bar	gr	L/min	€/PZ
FGA 346/B	65000	6	100	150	220,00

LEVIGATRICE ROTO-ORBITALE

Equipaggiata con disco a 15 fori
Filettatura 5/16"-24 UNF
Impugnatura a palmo con corpo principale rivestito in PVC ruvido anti-scivolo
Attacco aria 1/2" gas
Ø interno tubo aria 10mm (3/8")



CODICE	Platereello mm	RPM	Bar	Ømm orbita	gr	L/min	€/PZ
FGA 340	152	11000	6.2	5	900	45.2	295,00
FGA 340/B	150	11000	6.2	2.5	800	46	295,00

KIT**KIT MANUTENZIONE FGA 340-FGA 340/B**

CODICE	€/PZ
FGA 340/KIT	30,00

LEVIGATRICE PNEUMATICA PER RIMOZIONE RESIDUI GOMMOSI

Sistema rapido di intercambiabilità del disco in gomma
Sistema di aggancio con filettatura 5/16" - 24UNF
Corpo ricoperto in gomma anti-scivolo
Attacco aria 1/4" gas
Ø interno tubo aria 10mm (3/8")



CE

CODICE	RPM	Bar	gr	L/min	L/mm	€/PZ
FGA 337	2600	6.2	800	85	190	125,00

DISCO DI RICAMBIO

Filettatura 5/16"-24 UNF

CODICE	€/PZ
FGA 337/R1	16,00

KIT**KIT MANUTENZIONE BASE PER FGA 337**

CODICE	€/PZ
FGA 337/KIT	28,00

LEVIGATRICE ROTO-ORBITALE

Equipaggiata con disco da 75mm a 3 fori
Movimento roto-orbitale da 2.5mm
Filettatura 5/16"-24 UNF
Impugnatura a palmo con corpo principale rivestito in PVC ruvido anti-scivolo
Attacco aria 1/4" gas
Ø interno tubo aria 10mm (3/8")



CODICE	Platorello mm	RPM	Bar	gr	L/min	€/PZ
FGA 342/B	75	11000	6.2	500	46	285,00

LEVIGATRICE MULTI-FUNZIONE

Sistema di aspirazione integrato nel corpo macchina
Supporto laterale girevole a 180°
Impugnatura ergonomica
Attacco aria 1/4" gas
Ø interno tubo aria 10mm (3/8")



CODICE	RPM	Bar	gr	Litri/minuti	L/mm	€/PZ
FGA 341	4000	6.2	1200	102	250	650,00

KIT



KIT MANUTENZIONE BASE FGA 341

CODICE	€/PZ
FGA 341/KIT	20,00

ACCESSORI DI RICAMBIO PER FGA 341



CODICE	Ø/mm	€/PZ	
FGA 341/R1	110	33,00	
FGA 341/R2	65	25,00	
FGA 341/R3	110	22,00	
FGA 341/R4	110/0.5	Fine	25,00
FGA 341/R5	110/0.5	Media	29,00
FGA 341/R6	110/0.7	Grossa	30,00

LEVIGATRICE ORBITALE

Diametro orbita: 2mm
Dotata di 3 platorelli porta dischi di diametro e dimensioni differenti
Testa angolare inclinata a 90°
Filettatura 1/4"-20 UNF
Sistema di azionamento a pinza
Corpo rivestito in gomma anti-scivolo
Attacco aria 1/4" gas
Ø interno tubo aria 10mm (3/8")



CODICE	RPM	Bar	gr	L/min\	€/PZ
FGA 342	13000	6.2	500	74	220,00

SET 50 DISCHETTI PER FGA 342



CODICE	Ø/mm	Grana	€/PZ
FGA 342/R120	32	120	22,00
FGA 342/R180	32	180	22,00
FGA 342/R320	32	320	22,00
FGA 342/R1000	32	1000	27,00
FGA 342/R1500	32	1500	27,00
FGA 342/RT120	50	120	55,00
FGA 342/RT180	50	180	55,00
FGA 342/RT320	50	320	55,00
FGA 342/RT1000	50	1000	55,00
FGA 342/RT1500	50	1500	55,00
FGA 342/T120	32	120	60,00
FGA 342/T180	32	180	60,00
FGA 342/T320	32	320	60,00
FGA 342/T1000	32	1000	72,00
FGA 342/T1500	32	1500	72,00

KIT



KIT MANUTENZIONE BASE PER FGA 342

CODICE	€/PZ
FGA 342/KIT	20,00



LEVIGATRICE A NASTRO

Dimensione nastro: 10x330mm
Fornita con un kit 3 nastri di serie
Attacco aria 1/4" gas
Ø interno tubo aria 10mm (3/8")



CE

CODICE	Hp	RPM	Bar	gr	L/min	€/PZ
FGA 343/N10	0.70	18000	6.2	800	90	220,00

KIT**KIT MANUTENZIONE BASE FGA 343/N10 E FGA 343/N20**

CODICE	€/PZ
FGA 343N10/KIT	20,00

LEVIGATRICE A NASTRO

Dimensione nastro: 20x520mm
Fornita con un kit 3 nastri di serie
Attacco aria 1/4" gas
Ø interno tubo aria 10mm (3/8")



CE

CODICE	Hp	RPM	Bar	gr	L/min	€/PZ
FGA 343/N20	0.70	18000	6.2	960	107	285,00

KIT**KIT MANUTENZIONE BASE FGA 343/N10 E FGA 343/N20**

CODICE	€/PZ
FGA 343N20/KIT	20,00

MARTELLO SCALPELLATORE COMPLETO DI 5 SCALPELLI

Fornito con 5 scalpelli
Dimensione attacco: 11mm
Dimensione pistone: 19mm
Corpo in acciaio con impugnatura in PVC anti-scivolo
Modello a pistola
Fornito in box di ABS
Attacco aria 1/4" gas
Ø interno tubo aria 10mm (3/8")



CE

CODICE	Colpi al minuto	Bar	gr	L/min	€/PZ
FGA 345	2000	6.2	1940	78.4	320,00

KIT**KIT MANUTENZIONE BASE PER FGA 345**

CODICE	€/PZ
FGA 345/KIT	20,00

MOLLA DI TENUTA PER FGA 345

CODICE	€/PZ
FGA 345/M	10,50

SCROSTATORE PER FGA 345

CODICE	€/PZ
FGA 345/SC	110,00

SCALPELLI PER FGA 345

CODICE	L/mm	€/PZ
FGA 345/S1	175	12,00
FGA 345/S2	175	12,00
FGA 345/S3	175	18,00
FGA 345/S4	175	13,50
FGA 345/S5	175	9,50

PISTOLA DI LAVAGGIO

Corpo in alluminio nichelato
Capacità 1 litro
Tubo pescante in acciaio
Valvola ad apertura progressiva
Dotata di regolatore consumo aria
Dotata di regolatore portata liquido
Ugello di regolazione getto
Attacco 1/4"



CE

CODICE	gr	L/min	L/mm	€/PZ
FGA 380	750	131	420	76,00

TUBO IN POLIURETANO RINFORZATO ESTENDIBILE, COMPLETO DI RACCORDI E ATTACCO MASCHIO



CODICE	Ø/mm	Ø/Gas	L/mt	€/PZ
FGA 383	9	8x12	1/4"	85,00
FGA 383/2	12	8x12	1/4"	88,00
FGA 383/3	9	11x16	3/8"	120,00

RACCORDO PER FGA 383

Tubo estendibile per aria compressa, dotato di raccordo ed innesto rapido



CODICE	Ø/mm	Ø/Gas	€/PZ
FGA 384/R1	8x12	1/4"	10,00
FGA 384/R2	11x16	1/4"	11,00

TUBO IN PVC FLESSIBILE COMPLETO DI RACCORDI E ATTACCO MASCHIO



CODICE	Ø/mm	Ø/Gas	L/mt	€/PZ
FGA 382/B10	10	8x12	1/4"	68,00
FGA 382/B15	15	8x12	1/4"	80,00
FGA 382/B20	20	8x12	1/4"	90,00
FGA 384/B15	15	10x15	3/8"	100,00

PISTOLA DI SOFFIAGGIO

Valvola ad apertura progressiva
Filettatura in ottone



CE



CODICE	€/PZ
FGA 416	20,00

FILTRO REGOLATORE LUBRIFICATORE

Pressione d'uso: 1.5-9.0BAR/21-128PSI
Temperatura di utilizzo: 5-60°



CODICE	Portata max L/min	Capacità tazza olio cc	Capacità tazza aria cc	Gr	Attacco	€/PZ
FGA 385	4000	75	40	980	1/4"	135,00
FGA 386	4000	75	40	980	3/8"	135,00
FGA 387	4000	75	40	980	1/2"	135,00

PISTOLA DI SOFFIAGGIO

Valvola ad apertura progressiva
Corpo in alluminio nichelato
Impugnatura in gomma anti-scivolo



CE

CODICE	€/PZ
FGA 419	21,00

RACCORDI PER UTENSILI AD ARIA COMPRESSA



CODICE	BSPP	€/PZ
FGA 381/1	1/4"	11,50
FGA 381/2	3/8"	11,50
FGA 381/3	1/2"	11,50

RACCORDI PER UTENSILI AD ARIA COMPRESSA



CODICE	BSPP	€/PZ
FGA 381/4	1/4"	12,00
FGA 381/5	3/8"	12,00



RACCORDI PER UTENSILI AD ARIA COMPRESSA



CODICE	€/PZ
FGA 381/6	13,00
FGA 381/7	13,00

RACCORDI PER UTENSILI AD ARIA COMPRESSA



CODICE	BSPT	€/PZ
FGA 380/1	1/2"	4,50
FGA 380/2	1/4"	3,50
FGA 380/3	3/8"	3,50

RACCORDI PER UTENSILI AD ARIA COMPRESSA



CODICE	BSPP	€/PZ
FGA 380/4	1/2"	4,50
FGA 380/5	1/4"	3,50
FGA 380/6	3/8"	3,50

RACCORDI PER UTENSILI AD ARIA COMPRESSA

Japan style



CODICE	BSPT	€/PZ
FGA 381/1N	1/4"	10,50
FGA 381/2N	3/8"	10,50
FGA 381/3N	1/2"	11,00

RACCORDI PER UTENSILI AD ARIA COMPRESSA

Japan style



CODICE	BSPT	€/PZ
FGA 381/4N	1/4"	11,50
FGA 381/5N	3/8"	11,50

RACCORDI PER UTENSILI AD ARIA COMPRESSA

Japan style



CODICE	BSPT	€/PZ
FGA 380/1N	1/2"	4,50
FGA 380/2N	1/4"	3,50
FGA 380/3N	3/8"	3,50

RACCORDI PER UTENSILI AD ARIA COMPRESSA

Japan style



CODICE	BSPT	€/PZ
FGA 380/4N	1/2"	4,50
FGA 380/5N	1/4"	3,50
FGA 380/6N	3/8"	3,50

RACCORDI PER UTENSILI AD ARIA COMPRESSA



CODICE	Uscita mm	BSP	€/PZ
FGA 377/1	6	1/4"	25,50

RACCORDI PER UTENSILI AD ARIA COMPRESSA



CODICE	Uscita mm	BSP	€/PZ
FGA 377/2	6	1/4"	21,00

RACCORDI PER UTENSILI AD ARIA COMPRESSA



CODICE	Uscita mm	€/PZ
FGA 377/3	6	25,50

RACCORDI PER UTENSILI AD ARIA COMPRESSA



CODICE	BSP	Ingresso mm	€/PZ
FGA 376/1	1/4"	6	6,50
FGA 376/2	1/4"	6	6,50

RACCORDI PER UTENSILI AD ARIA COMPRESSA



CODICE	Uscita mm	BSP	€/PZ
FGA 379/1	8	3/8"	33,00

RACCORDI PER UTENSILI AD ARIA COMPRESSA



CODICE	Uscita mm	BSP	€/PZ
FGA 379/2	8	3/8"	31,00

RACCORDI PER UTENSILI AD ARIA COMPRESSA



CODICE	Uscita mm	€/PZ
FGA 379/3	8	33,00

RACCORDI PER UTENSILI AD ARIA COMPRESSA



CODICE	BSP	Ingresso mm	€/PZ
FGA 378/1	1/4"	8	10,00
FGA 378/2	1/4"	8	10,00

OLIO LUBRIFICATORE PER UTENSILI PNEUMATICI

500CC
 Densità a 20°: 875 Kg/m³
 Viscosità a 40°: 32 cST
 Infiammabilità COC: 210°



CODICE	€/PZ
FGA 388/OL	18,00

RACCORDO UNIVERSALE ROTANTE



CODICE	BSPT	BSP	€/PZ
FGA 380/SN	1/4"	1/4"	20,00

AVVOLGITUBO AUTOMATICO PER ARIA COMPRESSA -15MT

Ø tubo: 8x12mm
 Tubo in poliuretano retinato
 Staffa a muro orientabile a 360°
 Guida di scorrimento automatico
 Sistema di bloccaggio a qualsiasi lunghezza
 Riavvolgimento a velocità controllata



CODICE	€/PZ
FGA 383/AR15	270,00

AVVOLGITUBO AUTOMATICO PER ARIA COMPRESSA -15MT

Ø tubo: 10x13mm
 Tubo in poliuretano retinato
 Staffa a muro orientabile a 360°
 Guida di scorrimento automatico
 Sistema di bloccaggio a qualsiasi lunghezza
 Riavvolgimento a velocità controllata



CODICE	€/PZ
FGA 385/AR15	360,00





0
12.2 V

Pistone 1

Pistone 2

Pistone 3

Pistone 4



11

**UTENSILI SPECIALI
PER AUTOMOTIVE**



CHIAVE A TAZZA PER FILTRI OLIO



CODICE	Lati	Ømm	€/PZ
FG 175/B1	14	65	9,00
FG 175/B2	14	65/67	9,00
FG 175/B3	14	68	9,00
FG 175/B4	14	73	9,00
FG 175/B5	15	74	9,00
FG 175/B6	15	74/76	9,00
FG 175/B7	15	75/77	9,00
FG 175/B8	14	76	9,00
FG 175/B9	8	76	9,00
FG 175/B10	15	78	9,50
FG 175/B11	15	80	9,50
FG 175/B12	15	80/82	10,00
FG 175/B13	16	86	10,00
FG 175/B14	15	90	10,00
FG 175/B15	10	92	10,00
FG 175/B16	15	93	10,00
FG 175/B17	15	95	10,00
FG 175/B18	15	100	12,00
FG 175/B19	15	106	12,00
FG 175/B20	15	108	12,00
FG 175/B21	15	135	20,00

CHIAVE A TAZZA PER FILTRI OLIO - MOD. PURFLUX



CODICE	Lati	Ømm	€/PZ
FG 175/PF66	6	66	10,00
FG 175/PF76-12	12	76	10,00
FG 175/PF76-30	30	76	10,00
FG 175/PF86-18	18	86	11,00
FG 175/PF93-36	36	96	11,00
FG 175/PF93-45	45	93	11,00
FG 175/PF96-18	18	96	11,50
FG 175/PF108-18	18	108	12,50
FG 175/PF135-18	18	135	22,00

SET 4 CHIAVI A TAZZA PER FILTRI OLIO - MOD. PURFLUX



CODICE	Contenuto	€/PZ
FG 175PF/S4	FG 175/PF66, FG 175/PF76, FG 175/PF86, FG 175/PF96	74,50

SET 28 CHIAVI A TAZZA PER FILTRI OLIO



CODICE	Contenuto	€/PZ
FG 175/S30	FG 175/B1 - FG 175/B20 FG 175/PF66 - FG 175/PF108-18 01 Chiave per filtri olio regolabile 60-120mm 01 Adattatore 1/2"x 3/8"	221,50

CHIAVE A TAZZA PER RIMOZIONE CARTUCCE FILTRI OLIO



CODICE	Lati	Ømm	●/mm	□	€/PZ
FG 175/C1	6	24	27	1/2"	9,50
FG 175/C2	6	27	27	1/2"	9,50
FG 175/C3	6	30	27	1/2"	9,50
FG 175/C4	6	32.5	27	1/2"	10,00
FG 175/C5	6	36	27	1/2"	10,00
FG 175/C6	6	38	27	1/2"	10,00

SET CHIAVI A TAZZA PER RIMOZIONE CARTUCCE FILTRI OLIO



CODICE	Contenuto	€/PZ
FG 175/S6	6pz	62,00

CHIAVE A TAZZA PER FILTRI OLIO FORD 1.0, 2.0, 2.3 ECOBOOST



CODICE	Lati	Ømm	€/PZ
FG 175/FO74	14	74	45,50

CHIAVE A TAZZA PER FILTRI OLIO FORD 1.5, 1.6 ECOBOOST



CODICE	Lati	Ømm	€/PZ
FG 175/FO74.5	15	74.5	45,50

CHIAVE A TAZZA PER FILTRI OLIO FIAT, LANCIA, ALFA ROMEO

Adatta per i motori Fiat/Lancia 1.0L mild hybrid dal 2020

NEW



CODICE	Lati	Ømm	€/PZ
FG 175/FO74.5-8	8	74.5	50,00

CHIAVE A TAZZA PER FILTRI OLIO

In acciaio spessorato



CODICE	Lati	Ømm	H/mm	€/PZ
FG 175/FO8	8	78	35	39,50
FG 175/FO10	10	95	43	50,00
FG 175/FO14	14	75	43	53,00
FG 175/FO15	15	105	67	65,00

CHIAVE A TAZZA PER FILTRI OLIO MOTORI MERCEDES

In acciaio spessorato



CODICE	Lati	Ømm	€/PZ
FG 175/FO84	14	84	57,00

CHIAVE A TAZZA PER FILTRI OLIO MOTORI MERCEDES CDI



CODICE	Lati	Ømm	€/PZ
FG 175/FO14M	14	74	35,50

CHIAVE A TAZZA PER FILTRI OLIO MOTORI TOYOTA



CODICE	Lati	Ømm	€/PZ
FG 175/FO14T	14	79	30,00

CHIAVE A TAZZA PER FILTRI OLIO MOTORI HYUNDAI TUCSON



CODICE	Lati	Ømm	€/PZ
FG 175/HI	14	81	67,00



CHIAVE FILTRO OLIO OPEL/VAUXHALL



CODICE	Lati	Ømm	€/PZ
FG 175/OP1	15	74,7	46,50

CHIAVE MONTAGGIO/SMONTAGGIO SEDE IN PLASTICA FILTRI OLIO MOTORE OPEL



CODICE	Ømm	€/PZ
FG 175/A32	32	29,00

CHIAVE A NASTRO REGOLABILE PER FILTRI OLIO



CODICE	Ømm	€/PZ
FG 176/RP	65-110	46,50
FG 176/RP2	110-150	49,50

CHIAVE A NASTRO REGOLABILE PER FILTRI OLIO



CODICE	Ømm	€/PZ
FG 176/RE	65-110	36,50

NASTRO DI RICAMBIO PER FG 176/RE E FG 176/RP



CODICE	€/PZ
FG 176/RE-SP	9,00

CHIAVE A NASTRO PER FILTRI OLIO



CODICE	Ømm	€/PZ
FG 176/NA1	160	36,50
FG 176/NA2	240	41,50

NASTRO DI RICAMBIO PER FG 176/NA1 E FG 176/NA2

CODICE	€/PZ
FG 176/NA1-R	16,00
FG 176/NA2-R	18,50

CHIAVE SNODATA A CATENA DOPPIA SOTTILE PER FILTRI OLIO



CODICE	Ømm	€/PZ
FG 177/F01	60-115	85,00

CHIAVE SNODATA A CATENA DOPPIA PER FILTRI OLIO



CODICE	Ømm	€/PZ
FG 176/F01	60-110	88,00
FG 176/F02	60-160	93,00

CATENA DI RICAMBIO

CODICE	€/PZ
FG 176/F01-C	33,00
FG 176/F02-C	46,50
FG 177/F01-C	43,00

CHIAVE REGOLABILE PER FILTRI OLIO A 3 GRIFFE



CODICE	Ømm	€/PZ
FG 178/SD	95-165	140,00

CHIAVE REGOLABILE PER FILTRI OLIO A 3 GRIFFE



CODICE	Ømm	€/PZ
FG 178/3L	60-120	30,00

CHIAVE REGOLABILE PER FILTRI OLIO



CODICE	€/PZ
FG 176/CJ	33,00

CHIAVE AUTOSERRANTE PER FILTRI OLIO PER SERRAGGI DESTORSI E SINISTRORSI - MODELLO PESANTE

Attacco 1/2"
Sistema di rimozione e montaggio del filtro facile e veloce
Molla di trazione per facilitare il fissaggio del filtro

NEW



CODICE	Ømm	€/PZ
FG 178/UF110	80 - 110 mm	115,00
FG 178/UF145	104 - 145 mm	165,00

CHIAVE A BUSSOLA XZN PER TAPPI OLIO



CODICE	M	€/PZ
FG 175/XZN16	16	8,50

SET RIPARAZIONE TAPPI OLIO



CODICE	Contenuto	€/PZ
FG 175/S114	M13x1.25, M13x1.5, M15x1.5, M17x1.5, M20x1.5, M22x1.5	265,00

TAPPI OLIO DI RICAMBIO PER FG 175/S114



CODICE	€/PZ
FG 175/OD13x1.25	3,50
FG 175/OD13x1.5	3,50
FG 175/OD15x1.5	3,50
FG 175/OD17x1.5	3,40
FG 175/OD20x1.5	3,40
FG 175/OD22x1.5	4,20

RONDELLE DI RICAMBIO PER FG 175/S114

CODICE	€/PZ
FG 175/W13x1.5	0,50
FG 175/W15x1.5	0,50
FG 175/W17x1.5	0,60
FG 175/W20x1.5	0,80
FG 175/W22x1.5	0,90

MASCHI DI RICAMBIO PER FG 175/S114

CODICE	€/PZ
FG 175/M13x1.25	16,00
FG 175/M13x1.5	15,00
FG 175/M15x1.5	16,00
FG 175/M17x1.5	18,50
FG 175/M20x1.5	19,50
FG 175/M22x1.5	21,50



CHIAVE TAPPI OLIO MOTORE 8X10 MM



CODICE	€/PZ
FG 175/A8X10	23,00

SET 15 CHIAVI A BUSSOLA MAGNETICHE PER TAPPI OLIO



CODICE	Contenuto	€/PZ
FG 175/S15	Esagono maschio 8, 10, 12, 14, 17 mm Esagono femmina 13, 14, 17, 18, 19, 21 mm Torx TX45	135,00

SET UTENSILI PER SMONTAGGIO TAPPI OLIO IN PLASTICA

Adatto per VAG TFSI E TDI, FORD, BMW, CITROEN/PEUGEOT



CODICE	€/PZ
FG 175/S4	72,50

SET 3 TAPPI OLIO IN PLASTICA PER MOTORI VAG, TFSI E TDI

Adatto per VAG 1.8, 2.0 TSI/TFSI, VAG 1.6, 2.0 TDI



CODICE	€/PZ
FG 175/PO	14,00

TAPPO OLIO IN PLASTICA MOTORI FORD E PSA

Adatto per FORD 2.0 TDCI, PSA 2.0 HDI



CODICE	€/PZ
FG 175/PO1	12,00

TAPPO OLIO IN PLASTICA MOTORI FORD

Adatto per FORD 1.5, 1.6 TDCI, 1.0, 1.6 Ecoboost, 1.5, 5.2 benzina, 6.2, 6.7, 6.8 Diesel



CODICE	€/PZ
FG 175/PO2	14,00

TAPPO OLIO IN PLASTICA MOTORI BMW

Adatto per BMW 1.6 N13/N20, BMW 1.6, 2.0 N26



CODICE	€/PZ
FG 175/PO3	12,00

IMBUTO UNIVERSALE PER OLIO



CODICE	€/PZ
FG 178/UF	60,00

IMBUTO PER RECUPERO LIQUIDI



CODICE	L	€/PZ
FG 178/20L	20	95,00

INSERITORI AD ESPANSIONE PER CUSCINETTI E PARA-OLII



CODICE	Ømm	€/PZ
FG 178/P1	9,5 - 50	85,00
FG 178/P2	18 - 90	110,00

POMPA PER INSERIMENTO OLIO CAMBI E DIFFERENZIALI MANUALI E AUTOMATICI

Fornito di 12 accessori per connessione diretta
Dotato di valvola di non ritorno



CODICE	Capacità l	€/PZ
FG 176/S13	7,5	445,00

IMBUTO PER INSERIMENTO LIQUIDO ADBLUE



CODICE	Capacità l	€/PZ
FG 491/AD1	1,1	35,00
FG 491/AD2	1,1	36,00

SIRINGA PER OLIO E FLUIDI

Fornita con 2 guarnizioni di ricambio



CODICE	Capacità l	€/PZ
FG 491/200	0,2	38,00

SIRINGA PER OLIO E FLUIDI

Non adatta per carburanti e olii minerali



CODICE	Capacità l	€/PZ
FG 491/1500	1,5	85,00

SIRINGA PER FLUIDI A DOPPIA MANDATA

Guarnizioni in VITON



CODICE	Capacità l	€/PZ
FG 491/AD550	0,55	125,00

SIRINGA PER ESTRAZIONE CARBURANTE DEL CIRCUITO DIESEL

Dotata di adattatori a innesto rapido



CODICE	Capacità l	€/PZ
FG 491/DF1500	1,5	135,00



POMPA DI PRESSIONE E DEPRESSIONE



CODICE	€/PZ
FG 202/PV	230,00

STRUMENTO PER IL RIEMPIMENTO A DEPRESSIONE DEI CIRCUITI DI RAFFREDDAMENTO

Utile per effettuare uno spurgo perfetto grazie alla messa sotto vuoto del circuito di raffreddamento



CODICE	€/PZ
FG 203/S7	166,00

KIT CONTROLLO TENUTA IMPIANTO DI RAFFREDDAMENTO



CODICE	Contenuto	€/PZ
FG 203/S20	21pz	370,00

TAPPI OPTIONAL PER FG 203/S20



CODICE	€/PZ
FG 203/BW1	36,50
FG 203/FO1	36,50
FG 203/FO2	36,50
FG 203/OP1	36,50
FG 203/TO1	36,50

SET RIPRISTINO PRESSIONE CIRCUITO CARBURANTE SISTEMI DIESEL

Nuovo modello con pompa bi-direzionale



CODICE	€/PZ
FG 201/S7	340,00

CHIAVE A BUSSOLA PER SMONTAGGIO TAPPI RADIATORE



CODICE	€/PZ
FG 203/A	23,00

SET UNIVERSALE PER ESTRAZIONE ELETTRO-INIETTORI BOSCH, DELPHI, SIEMENS E DENSO

Completo di massa battente 4.8 kg



CODICE	M	€/PZ
FG 191/S22	18	620,00

UTENSILI PER ESTRAZIONE ELETTRO-INIETTORI



CODICE	Descrizione	€/PZ
FG 191/ES-SN	1- Giunto snodato universale	33,00
FG 190/EL1A	2- Attrezzo rimozione elettrodo elettro-iniettori Ø 7.5	11,00
FG 190/EL1	3- Attrezzo rimozione elettrodo elettro-iniettori Ø 6,6	11,00
FG 191/ES-6	4- Adattatore con filettatura esterna M16X1,0	27,50
FG 191/ES-7	5- Adattatore con filettatura esterna M17X1	27,50
FG 191/ES-8	6- Adattatore con filettatura esterna M20X1	27,50
FG 191/ES-9	7- Adattatore con filettatura esterna M25X1	33,00
FG 191/ES-10	8- Adattatore con filettatura esterna M27X1	33,00
FG 191/ES-2	9- Adattatore con filettatura interna M16X1,5	27,50
FG 191/ES-1	10- Adattatore con filettatura interna M14X1,5	27,50
FG 191/ES-3	11- Adattatore con filettatura interna M25X0,5	33,00
FG 191/ES-4	12- Adattatore con filettatura interna M25X0,75	33,00
FG 191/ES-5	13- Adattatore con filettatura interna M27X1,0	33,00
FG 190/A25	14- Bussola rimozione connessione elettrica Ø 25	42,00
FG 190/A27	15- Bussola rimozione connessione elettrica Ø 27	42,00
FG 190/A29	16- Bussola rimozione connessione elettrica Ø 29	42,00
FG 190/A30	17- Bussola rimozione connessione elettrica Ø 30	42,00
FG 191/ES-11	18- Estrattore a forchetta apertura 12 mm	33,00
FG 191/ES-12	19- Estrattore a forchetta apertura 13,5 mm	33,00
FG 191/ES-13	20- Estrattore a forchetta apertura 16 mm	33,00
FG 191/ES-14	21- Estrattore a forchetta apertura 26 mm	33,00
FG 191/MI	22- Massa battente 4.8 kg	198,00

ESTRATTORE A FORCHETTA PER INIETTORI PIEZO ELETTRICI



CODICE	M	€/PZ
FG 190/AD1	16	52,00

ESTRATTORE LATERALE PER ELETTRO-INIETTORI BOSCH



CODICE	M	€/PZ
FG 190/AD2	16	34,00

ESTRATTORE PER RONDELLE INIETTORI



CODICE	€/PZ
FG 190/RI	56,00

UTENSILE PER ESTRAZIONE UGELLO ELETTRO-INIETTORI



CODICE	€/PZ
FG 190/IP	48,00

ESTRATTORE INIETTORI OPEL MOTORI BENZINA AD INIEZIONE DIRETTA



CODICE	€/PZ
FG 190/OP	45,00



ESTRATTORI INIETTORI DIESEL M9R - RENAULT/OPEL/NISSAN



CODICE	€/PZ
FG 190/RE	235,00

MASSA BATTENTE A PERCUSSIONE



CODICE	L/mm	M	€/PZ
FG 190/MI	170	16	85,00

MASSA BATTENTE A PERCUSSIONE



CODICE	L/mm	M	€/PZ
FG 190/MI2	460	16	96,00

KIT ESTRAZIONE INIETTORI BMW N54/MINI N14



CODICE	€/PZ
FG 190/S8	140,00

ATTREZZO PER RIMOZIONE ELETTRODO ELETTRO-INIETTORI



CODICE	Ømm	€/PZ
FG 190/EL	7.5	11,00

BUSSOLE RIMOZIONE CONNESSIONE ELETTRICA-INIETTORI BOSCH E SIEMENS



CODICE	Ø/mm	Applicazione	€/PZ
FG 190/A25	25	Siemens	42,00
FG 190/A27	27	Siemens	42,00
FG 190/A29	29	Bosch	42,00
FG 190/A30	29	Bosch	42,00

SET PER VERIFICA ELETTRO-INIETTORI DIESEL COMMON RAIL

Supporto a 6 burette
Adattato per Bosch, Siemens, Denso, e Delphi



CODICE	€/PZ
FG 201/CR	250,00

SET PER FRESATURA SEDI INIETTORI



CODICE	Contenuto	€/PZ
FG 190/S6B	6pz	165,00

UTENSILI PER FRESATURA SEDI INIETTORI



CODICE	Descrizione	€/PZ
FG 190/S6-1	1- Fresa piana 17x17mm	44,00
FG 190/S6-2	2- Fresa piana 15x19mm	44,00
FG 190/S6-3	3- Fresa piana 17x19mm	44,00
FG 190/S6-4	4- Fresa conica 17x21mm	44,00
FG 190/S6-5	5- Fresa conica 17x17mm	44,00



FASANO
TOOLS

ASSORTIMENTO 21 UTENSILI E ALESATORI PER PULIZIA SEDI INIETTORI E CANDELETTE



CODICE	€/PZ
FG 190/S21	350,00

UTENSILI E ALESATORI PER PULIZIA SEDI INIETTORI E CANDELETTE



CODICE	Descrizione	€/PZ
FG 190/S21-1	1- Asta porta frese dotato di molla per regolare la profondità	38,40
FG 190/S21-4	2- Serie 3 adattatori conici per imbocco sede iniettore (per asta porta frese)	12,70
FG 190/S21-5	3- Prolunga flessibile a innesto rapido con attacco quadro femmina 1/4"	15,70
FG 190/S21-6	4- Porta spazzole corto con attacco quadro maschio 1/4"	16,50
FG 190/S21-7	5- Spazzola lunga per la pulizia della sede iniettore	21,90
FG 190/S21-8	6- Set 6 tappi chiusura sede iniettore	3,30
FG 190/S21-9	7- Asta per l'inserimento dei tappi chiusura sede iniettore	1,10
FG 139/B2.5	8- Chiavino esagonale a L (2.5 mm)	0,60
FG 139/B3	9- Chiavino esagonale a L (3 mm)	0,60
FG 190/S21-11	10- Mandrino per fresa Ø 19 mm	17,40
FG 190/S21-12	11- Spazzola con setole in nylon per pulizia sede iniettore	9,10
FG 190/S21-13	12- Spazzola corta per la pulizia della camera iniettore	20,40
FG 190/RI	13- Estrattore per rondella di tenuta in rame	56,00
FG 190/S21-15	14- Alesatore Ø 15,5 mm	38,80



KIT PER PULIZIA SEDI INIETTORI

In valigetta ABS

NEW



CODICE	€/PZ
FG 191/S14	150,00

UTENSILI PER PULIZIA SEDI INIETTORI



CODICE	Descrizione	€/PZ
FG 191/S14-2	1- Asta filettata M5X0.8XL200mm	3,00
FG 191/S14-3	2- Tappo chiusura sede iniettore	1,10
FG 191/S14-4	3- Spazzola lunga per la pulizia della sede iniettore	21,90
FG 191/S14-1	4- Prolunga flessibile	15,70
FG 191/S14-6	5- Spazzola a tazza Ø 15	28,30
FG 191/S14-7	6- Spazzola a tazza Ø 20	30,20
FG 191/S14-8	7- Spazzola Ø 24x85L	13,50
FG 191/S14-9	8- Spazzola Ø 18x85L	13,50
FG 191/S14-10	9- Spazzola Ø 21x85L	13,50

CHIAVE PER GHIERE GALLEGGianti SERBATOIO CARBURANTE GRUPPO FCA



CODICE	€/PZ
FG 174/F2	72,50

CHIAVE REGOLABILE PER GHIERE GALLEGGianti SERBATOIO CARBURANTE



CODICE	Ømm	€/PZ
FG 174/SC	88-170	118,50

CHIAVE PER GHIERE GALLEGGianti SERBATOIO CARBURANTE

Per ghiere in alluminio Fiat, VW, Opel, Mercedes, BMW



CODICE	L/mm	●/mm	□	€/PZ
FG 175/FT1	170	22	1/2	67,00

CHIAVE PER GHIERE GALLEGGianti SERBATOIO CARBURANTE

Per ghiere in plastica Citroen e Peugeot



CODICE	L/mm	●/mm	□	€/PZ
FG 175/FT2	157	22	1/2	82,50

CHIAVE PER GHIERE GALLEGGianti SERBATOIO CARBURANTE

Per ghiere in plastica FCA (Fiat Freemont, 500L, 500X, Jeep Renegade, etc)



CODICE	Ø/mm	●/mm	□	€/PZ
FG 175/FT3	145	22	1/2	82,50

CHIAVE PER GHIERE GALLEGGIANTI SERBATOIO CARBURANTE

Per ghiera in plastica gruppo VAG



1/2"

CODICE	Ø/mm	●/mm	□	€/PZ
FG 175/FT4	180	22	1/2	72,50

CHIAVE PER GHIERE GALLEGGIANTI SERBATOIO CARBURANTE

Per ghiera in alluminio gruppo OPEL



1/2"

CODICE	€/PZ
FG 175/FT5	72,50

CHIAVE RIMOZIONE FILTRO GASOLIO MOTORI MULTIJET



1/2"

CODICE	Ømm	€/PZ
FG 175/FG2	90	92,00

SET ESTRAZIONE CANDELETTE SPEZZATE



Punte per forare in titanio



Cono di centraggio/Estrattore in acciaio

CODICE	Contenuto	€/PZ
FG 182/S16	M8,M9,M10	500,00

UTENSILI PER ESTRAZIONE CANDELETTE SPEZZATE



CODICE	Descrizione	€/PZ
FG 72/GMC3	1- Giramaschi a cricchetto reversibile - mod. lungo	28,90
FG 182/S16-ES	2- Estrattore	66,00
FG 182/S16-PR	3- Prolunga doppia punta	32,00
FG 182/S16-PU10	4- Punta 7x4.2mm per FIAT Multijet	44,00
FG 182/S16-PR2	5- Prolunga per punta FIAT Multijet per 7x4.2mm	32,00
FG 139/3	6- Chiavino esagonale ad L 3 mm	1,60
FG 182/S16-GU	7- Guida per forare 6mm	4,50
FG 75/HSS3,5	8- Punte per forare 3.5 mm (2pz)	1,60
FG 182/S4-5	9- Inserto filettato M5	5,50
FG 182S16/S4-4	10- Prolunga + maschio M5X0.8 (FIAT Multijet)	25,00
FG 182S16/S4-3	11- Prolunga + maschio M8x1 (FIAT Multijet)	28,00
FG 182/S16-PU7	12- Punta per forare - 7x5.5mm	50,00
FG 182/S16-PU9	13- Punta per forare - 9x5.5mm	50,00
FG 72/GMC2	14- Giramaschi a cricchetto reversibile - mod. corto	23,00
FG 182/S4-1	15- Estrattore	55,00
FG 182/S16-IF14	16- Inserto filettato 1/4" (2pz)	10,00
FG 624L/TX10	17- Chiave a bussola Torx E10	11,00
FG 72/M8X1	18- Serie 2 maschi a mano in acciaio HSS	11,00
FG 72/M10x1	19- Serie 2 maschi a mano in acciaio HSS	13,00
FG 182/S16-MA14	20- Maschio 1/4"	9,00



SET CHIAVI A BUSSOLA PER CANDELETTE PRERISCALDAMENTO MOTORI DIESEL



CODICE	Contenuto	€/PZ
FG 183/S5	8,9,10,12,14mm	108,50

CHIAVE A BUSSOLA PER CANDELETTE PRERISCALDAMENTO MOTORI DIESEL



CODICE	Ømm	€/PZ
FG 183/B8	8	31,00
FG 183/B9	9	31,00
FG 183/B10	10	31,00
FG 183/B12	12	31,00
FG 183/B14	14	31,00

CHIAVE A BUSSOLA SMONTAGGIO CANDELE D'ACCENSIONE DA 3/8"



CODICE	Ømm	€/PZ
FG 181/A14	14	19,00
FG 181/A16	16	20,00
FG 181/A18	18 (11/16")	23,00
FG 181/A21	21 (13/16")	25,00

CHIAVE A BUSSOLA SMONTAGGIO CANDELE D'ACCENSIONE DA 1/2"



CODICE	Ømm	€/PZ
FG 181/B14	14	16,50
FG 181/B16	16	18,00
FG 181/B18	18 (11/16")	20,00
FG 181/B21	21 (13/16")	23,00

CHIAVE A BUSSOLA SNODATA PER CANDELE D'ACCENSIONE BMW



CODICE	Ømm	€/PZ
FG 181/C14	14	28,50

CHIAVI A BUSSOLA POLIGONALE PER SMONTAGGIO CANDELE D'ACCENSIONE DA 3/8"

14mm: BMW Mini, Citroen, Peugeot, Renault e Mercedes
16mm: BMW, Vauxhall/Opel, Jaguar e giapponesi



CODICE	Ømm	L/mm	€/PZ
FG 181/RE1	14	250	40,00
FG 181/RE2	16	250	40,00

SET 2 CHIAVI A BUSSOLA EXTRA-LUNGHE POLIGONALI PER RIMOZIONE CANDELE D'ACCENSIONE



CODICE	Contenuto	€/PZ
FG 181RE/S2	14, 16mm	79,50

CHIAVE A T SNODATA PER SMONTAGGIO CANDELE D'ACCENSIONE



CODICE	Ømm	€/PZ
FG 181T/A14	14	54,00
FG 181T/A16	16	55,00
FG 181T/A21	21	67,00

SET CHIAVI A T SNODATE PER SMONTAGGIO CANDELE D'ACCENSIONE



CODICE	Contenuto	€/PZ
FG 181/S3	14, 16, 21 mm	175,50

SET RIPRISTINA FILETTI CON ELICOLI



CODICE	Contenuto	€/PZ
FG 181/S17	M14x1.25	115,00

ELICOLI PER RIPRISTINO FILETTI



CODICE	Ømm	Min.	€/PZ
FG 193/M5	M5x0.8	50	0,60
FG 193/M6	M6x1.0	50	0,70
FG 193/M8	M8x1.25	50	0,80
FG 193/M10	M10x1.5	50	0,90
FG 193/M12	M12x1.75	25	1,20
FG 193/M14	M14x1.25	25	1,50

SET RIPRISTINA FILETTI CON ELICOLI



CODICE	Contenuto	€/PZ
FG 181/S130	M5x0.8, M6x1.0, M8x1.25, M10x1.5, M12x1.75	280,00

SET RIPRISTINA FILETTI CON ELICOLI



CODICE	Contenuto	€/PZ
FG 181/S115	M6x1.0, M8x1.25, M10x1.5, M12x1.75, M14x1.25	380,00

UTENSILE RIPRISTINO FILETTI SENSORE NOX

NEW

Adatto per motori diesel sia leggeri che pesanti
Doppia estremità per filetti da 20mm e 22mm
Pulisce le filettature nei fori dei sensori Nox senza danneggiare i sistemi di scarico
Utilizzabile anche per il filtro antiparticolato diesel e per la maggior parte dei sensori di scarico



CODICE	Passo	€/PZ
FG 183/NOX	M20x1.5, M22x1.5	30,00

SPESSIMETRO



CODICE	Lame	mm	€/PZ
FG 188/1	13	0.05 - 1.00	14,50
FG 188/2	20	0.05 - 1.00	19,50

INSERTO A BUSSOLA RINFORZATO XZN 9

Per smontaggio bulloni testata



CODICE	L/mmL/mm	€/PZ
FG 152L/RM9	9595	23,00

UTENSILE PER COMPRESIONE MOLLE VALVOLE MOTORI

Per BMW, Mini, Citroen, Peugeot



CODICE	€/PZ
FG 190/SV2	420,00

CHIAVE PER SMONTAGGIO SONDA LAMBDA



CODICE	mm	L/mm	€/PZ
FG 183/B85	22	85	39,50
FG 183/B110	22	110	47,50



PINZE PER INSERIMENTO SEGMENTI PISTONI



CODICE	Ømm	€/PZ
FG 197/B1	50-100	30,00
FG 197/B2	80-120	32,00
FG 197/B3	110-160	37,00

UTENSILI PER INSERIMENTO SEGMENTI PISTONI



CODICE	Ømm	€/PZ
FG 197/A3	50-100 x 76H	34,00
FG 197/A4	80-120 x 10H	40,00
FG 197/A6	110-160 x 152H	58,00

UTENSILE MONTAGGIO E SMONTAGGIO MOLLE VALVOLA



CODICE	€/PZ
FG 190/SV	130,00

 **FASANO**[®]
TOOLS

CHIAVE SMONTAGGIO VALVOLE METANO

Per Fiat Multipla e Punto (VBE 517, VBE 520, VBE 474 e VALE 110)



CODICE	Attacco mm	€/PZ
FG 800/2	36	120,00

CHIAVE SMONTAGGIO VALVOLE METANO

Per Opel Zafira



CODICE	Attacco mm	€/PZ
FG 800/5	36	120,00

CHIAVE SMONTAGGIO VALVOLE METANO

Per Fiat Panda, Punto Evo, Volkswagen



CODICE	Attacco mm	€/PZ
FG 800/3	32	120,00

CHIAVE SMONTAGGIO VALVOLE METANO

Per valvole metano MCR 110



CODICE	Attacco mm	€/PZ
FG 800/6	36	120,00

CHIAVE SMONTAGGIO VALVOLE METANO

Per Fiat Panda



CODICE	Attacco mm	€/PZ
FG 800/7	36	120,00

CHIAVE SMONTAGGIO VALVOLE METANO

Per Citroen C4 Picasso



CODICE	Attacco mm	€/PZ
FG 800/8	36	120,00

CHIAVE SMONTAGGIO VALVOLE GPL GRUPPO VAG



CODICE	€/PZ
FG 800/9	145,00

DENSIMETRO PER LIQUIDO BATTERIA



CODICE	L/mm	€/PZ
FG 172/BL	380	28,00

SET CONTROLLO PRESSIONE SISTEMI TURBO

Permette di verificare la tenuta dell'impianto di alimentazione dal collettore di aspirazione fino alla chiocciola del compressore



CODICE	Contenuto	€/PZ
FG 189/S13	31,38,46,51,55,60,65,70,75,80,85,90mm	230,00

SET PER SEPARAZIONE RACCORDI IMPIANTI DI CONDIZIONAMENTO, ALIMENTAZIONE E LUBRIFICAZIONE



CODICE	€/PZ
FG 185/S27	115,50

SET 4 UTENSILI PER SMONTAGGIO BOBINE



CODICE	€/PZ
FG 195/S4B	90,00



UTENSILE PER ESTRAZIONE BOBINE ACCENSIONE VOLKSWAGEN



CODICE	€/PZ
FG 195/VW	22,50

CHIAVE PER RUOTA LIBERA PULEGGIA ALTERNATORI RENAULT



CODICE	L1/mm	L2/mm	€/PZ
FG 179/H28	28	15	13,50

CHIAVE PER RUOTA LIBERA PULEGGIA ALTERNATORI NIPPODENSO



CODICE	L/mm	€/PZ
FG 179/H32	32	15,50

CHIAVE PER RUOTA LIBERA PULEGGIA ALTERNATORE BOSCH



CODICE	Denti	●/mm	L/mm	€/PZ
FG 179/PA20	33	17	19,45	16,00

CHIAVE PER RUOTA LIBERA PULEGGIA ALTERNATORE



CODICE	Denti	TX	€/PZ
FG 179/T50	31	50	30,00

CHIAVE PER RUOTA LIBERA PULEGGIA ALTERNATORE



CODICE	H	€/PZ
FG 179/H10	10	25,00

CHIAVE PULEGGIA ALTERNATORE BOSCH PER FIAT GRANDE PUNTO



CODICE	M	€/PZ
FG 179/GP	10	30,00

SET UTENSILI PER PULEGGE LIBERE ALTERNATORI



CODICE	€/PZ
FG 179/S16	160,00

UTENSILI PER PULEGGE LIBERE ALTERNATORI

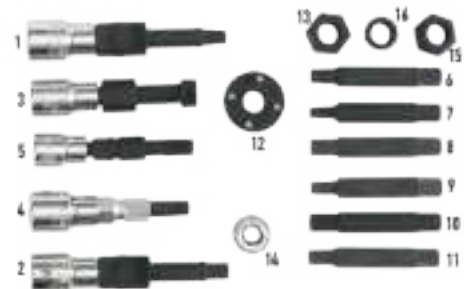

CODICE	Descrizione	€/PZ
FG 179/S16-1	1- Chiave per ruota libera puleggia alternatore TX50 - 33T	36,50
FG 179/GP	2- Chiave per ruota libera puleggia alternatore Bosh per Fiat Grande Punto	30,00
FG 179/H10	3- Chiave per ruota libera puleggia alternatore 10mm	25,00
FG 179/T50	4- Chiave per ruota libera puleggia alternatore TX50x31T	30,00
FG 179/S16-5	5- M10 attacco quadro 1/2"	40,20
FG 179/S16-6	6- Inserto T50 (lunghezza: 75 mm)	4,60
FG 179/S16-7	7- Inserto T40 (lenght: 75 mm)	4,60
FG 179/S16-8	8- Inserto M10 (lenght: 75 mm)	4,60
FG 179/S16-9	9- Inserto M8 (lenght: 75 mm)	4,60
FG 179/S16-10	10- Inserto H10 (lenght: 75 mm)	4,60
FG 179/S16-11	11- Inserto H8 (lenght: 75 mm)	4,60
FG 179/S16-12	12- H14 x 4 Perni per chiave per ruota libera puleggia alternatore	13,50
FG 179/S16-13	13- H20 Chiave per ruota libera puleggia alternatore	3,00
FG 179/S16-14	14- Adattatore attacco quadro da 1/2"	3,00
FG 179/S16-15	15- H22 x 33T Chiave per ruota libera puleggia alternatore	7,50
FG 179/S16-16	16- H15 x 33T Chiave per ruota libera puleggia alternatore	7,50

SET UTENSILI PER CENTRAGGIO FRIZIONI

Coni di centraggio Ø 12-20mm



CODICE	€/PZ
FG 180/S12	85,00

SET UTENSILI PER CENTRAGGIO FRIZIONI SAC



CODICE	Contenuto	€/PZ
FG 180/S38	01 piastra a 3 bracci, 01 piastra a 4 bracci, 06 centraggi conici (15x23, 15x28, 15x34, 15x26.5, 15x32.5, 15x32.5mm), 9 perni di centraggio (12, 14, 15, 15/22, 16, 17, 18, 19, 22/28mm)	700,00

SET UTENSILI PER DIAGNOSI DOPPIE FRIZIONI DMF



CODICE	€/PZ
FG 180/S17	590,00

APPARECCHIO SPURGO LIQUIDO FRENI

Alimentazione 12V con cavi batteria
Dotato di vano posteriore porta oggetti e contenitore di recupero olio
Dotato di sensore di fine liquido
Pressione regolabile fino a 2 Bar
Scocca in acciaio INOX



2 tappi in dotazione



CODICE	Capacità l	€/PZ
FG 178/SF	5	1.820,00

TAPPI OPTIONAL SPECIFICI PER MOTORI FORD



CODICE	€/PZ
FG 178SF/AD13	60,00
FG 178SF/AD14	60,00

SET TAPPI PER VEICOLI ASIATICI

Toyota, Hyundai, Nissan, Mitsubishi, Mazda, Subaru, Honda, Suzuki



CODICE	€/PZ
FG 178/S6	330,00



ASPIRATORE PNEUMATICO PER LIQUIDO FRENI

Dotato di sonde e attacchi universali



CODICE	Capacità l	€/PZ
FG 178/BF	2	255,00

SET ARRETRATORE PNEUMATICO PER PISTONCINI FRENI A DISCO

Per destrorsi e sinistrorsi



CODICE	€/PZ
FG 199/PF	225,00

SIRINGA PER ESTRAZIONE OLIO CIRCUITO FRENI

Dotata di attacchi specifici per raccordi circuito freno
Guarnizione interna in VITON



CODICE	Capacità l	€/PZ
FG 199/SF	0.2	60,00

PIASTRA ADATTATORE PER PINZE USURATE



CODICE	€/PZ
FG 199/PFP	22,00

PINZE PER MOLLE FRENI A TAMBURO



CODICE	L/mm	€/PZ
FG 199/PM1	210	37,00
FG 199/PM2	330	42,00
FG 199/PM3	540	112,00

PINZE PER FERMI MOLLE CEPPI FRENI A TAMBURO



CODICE	L/mm	€/PZ
FG 199/FM	185	32,00

PINZA PER FERMI CUSCINETTI MOZZO



CODICE	€/PZ
FG 165/FC	49,00

PINZE PER MOLLE FRENI A TAMBURO



CODICE	L/mm	€/PZ
FG 199/A	300	52,00

SET 11 UTENSILI PER SMONTAGGIO BULLONI PINZE FRENO

BMW, Ford, VAG, Mercedes



CODICE	Contenuto	Contenuto	€/PZ
FG 198/S11	1111		138,00

CHIAVE A BUSSOLA A 7 DENTI PER BULLONI PINZE FRENO



CODICE	Ø/mm	€/PZ
FG 198/B7	14	17,50
FG 198/B9	9	17,50

LEVA CON ESTREMITÀ A PUNTA PIATTA E CURVA



CODICE	L/mm	€/PZ
FG 125/B400	400	26,00

CALIBRO DIGITALE DI PROFONDITÀ PER BATTISTRADA PNEUMATICI



CODICE	L/mm	€/PZ
FG 198/DG	25	33,00

SET 4 INSERTI A BUSSOLA XZN PER MOZZI RUOTA



CODICE	Contenuto	€/PZ
FG 152RM/S4	M12,M14,M16,M18	67,00

CHIAVI A BUSSOLA POLIGONALI PER MOZZI RUOTA



CODICE	mm	Ø Esterno	€/PZ
FG 198/A30	30	42mm	32,00
FG 198/A32	32	44mm	32,00
FG 198/A34	34	47mm	32,00
FG 198/A35	35	49mm	34,00
FG 198/A36	36	50mm	38,00

CHIAVE A BUSSOLA ESAGONALE PER MOZZI RUOTA



CODICE	mm	€/PZ
FG 197/A36	36	40,00

CHIAVE A BUSSOLA POLIGONALE PER MOZZI RUOTA



CODICE	mm	€/PZ
FG 197/B36	36	40,00

CHIAVE A BUSSOLA POLIGONALE PER DADI MOZZO RUOTA DUCATI

Per dadi ruota anteriore e posteriore eccessivamente serrati o danneggiati
Attacco 1/2"
Finitura brunita

NEW



CODICE	mm	€/PZ
FG 198/DU55	55/30	85,00

CHIAVE A BUSSOLA POLIGONALE PER DADI MOZZO RUOTA POSTERIORE DUCATI E TRIUMPH

Per dadi ruota posteriore eccessivamente serrati o danneggiati
Attacco 1/2"
In alluminio

NEW



CODICE	mm	€/PZ
FG 198/DU46	41/46	70,00



CHIAVI A BUSSOLA RINFORZATE PER CERCHI IN LEGA LEGGERA



1/2"

CODICE	mm	L/mm	€/PZ
FG 628/R15	15	86	15,50
FG 628/R17	17	86	15,50
FG 628/R19	19	86	15,50
FG 628/R21	21	86	16,00
FG 628/R22	22	86	17,00

SET CHIAVI A BUSSOLA RINFORZATE PER CERCHI IN LEGA LEGGERA



CODICE	Pz	Contenuto	€/PZ
FG 628/S3	3	17,19,21mm	50,00
FG 628/S5	5	15,17,19,21,22mm	78,00

CHIAVI A BUSSOLA RINFORZATE PER CERCHI IN LEGA LEGGERA - MOD. LUNGO



1/2"

CODICE	mm	L/mm	€/PZ
FG 628R/L17	17	150	26,00
FG 628R/L19	19	150	26,00
FG 628R/L21	21	150	26,00

SET CHIAVI A BUSSOLA RINFORZATE PER CERCHI IN LEGA LEGGERA - MOD. LUNGO



CODICE	Pz	Contenuto	€/PZ
FG 628L/S3	3	17,19,21mm	98,00

SET 3 BUSSOLE PER CERCHI IN LEGA LEGGERA CON ADATTATORI PER BULLONI DANNEGGIATI



CODICE	€/PZ
FG 628/S7	115,00

CHIAVI A BUSSOLA RINFORZATE MAGNETICHE PER CERCHI IN LEGA LEGGERA



1/2"

CODICE	mm	€/PZ
FG 627/R17	17	28,00
FG 627/R19	19	28,00
FG 627/R21	21	28,00

SET CHIAVI A BUSSOLA MAGNETICHE RINFORZATE PER CERCHI IN LEGA LEGGERA



CODICE	Pz	Contenuto	€/PZ
FG 627/S3	3	17,19,21mm	85,00

LEVA PER VALVOLE PNEUMATICI



CODICE	L/mm	€/PZ
FG 126/VP	335	22,50

SET 4 LEVE IN NYLON



CODICE	€/PZ
FG 186P/S4	24,00

CHIAVE A BUSSOLA RINFORZATA PER DADI BULLONI

Attacco quadro interno 1/2"



CODICE	mm	Applicazione	€/PZ
FG 628/R17.5	16.5x17.5	FIAT, JEEP	20,00
FG 628/R18.5	18.5x19.5	FORD	20,00
FG 628/R21.5	21x21.5	FORD GALAXY, VOLVO, TOYOTA	22,00
FG 628/R22.5	22x22.5	CHRYSLER DODGE, LAND ROVER, RANGE ROVER	22,00
FG 628/R27.5	27x27.5	LAND ROVER DISCOVERY, RANGE ROVER	25,00

PINZA PER EQUILIBRATURA RUOTE



CODICE	€/PZ
FG 65/SR250	33,50

PINZA PER RIMOZIONE PESI ADESIVI EQUILIBRATURA RUOTE



CODICE	€/PZ
FG 198/PE	60,00

KIT PER RIMOZIONE DADI ANTIFURTO CON COLLARE BMW

Completo di massa battente e box in ABS



CODICE	€/PZ
FG 164/S3	250,00

KIT PER RIMOZIONE DADI ANTIFURTO CON COLLARE BMW

Da usare con massa battente FG 190/MI, FG 190/MI2



CODICE	€/PZ
FG 164/S3B	170,00



SET RIMOZIONE DADI RUOTA ANTIFURTO BMW



CODICE	Applicazione	€/PZ
FG 164/A	BMW	130,00

SET RIMOZIONE DADI RUOTA ANTIFURTO BMW, VOLKSWAGEN, AUDI



CODICE	Applicazione	€/PZ
FG 164/C	BMW	240,00
FG 164/D	Volkswagen	246,00
FG 164/E	Audi	260,00

SET CHIAVI A BUSSOLA PER RIMOZIONE DADI RUOTA ANTIFURTO UNIVERSALE

Non utilizzare con avvitatori a percussione



CODICE	€/PZ
FG 164/S10	180,50

LEVA PER PNEUMATICI DOTATA DI PROTEZIONE IN ABS



CODICE	L/mm	€/PZ
FG 126/P500	500	46,50

LEVE PER PNEUMATICI



CODICE	L/mm	€/PZ
FG 126/A300	300	19,00
FG 126/A500	500	34,00
FG 126/A600	600	43,50

CHIAVE A CROCE PER DADI RUOTA



CODICE	Ømm	€/PZ
FG 198/A1	17x19x22x1/2"	38,00
FG 198/B1	24x27x32x3/4"	130,00
FG 198/A2	17x19x22x1/2"	38,00

AVVITATORE REVERSIBILE AD IMPULSI 18V

Brushless motor
 Scocca anteriore in acciaio resistente agli urti
 Led di puntamento
 Impugnatura bi-material per un maggiore grip
 Aggancio rinforzato
 Sistema di sgancio rapido
 Batteria al Litio 5.0 Ampere e 18 Volt
 Fornito in valigetta di ABS
 Fornito in valigetta di ABS



CODICE	Nm MAX	RPM	gr	Batterie	€/PZ
FG 166/LT2	1000	650	2900	2 x 18V	920,00
FG 166/LT	1000	650	2900	1 x 18V	750,00

BATTERIA DI RICAMBIO 5.0 AMPERE, 18V



CODICE	€/PZ
FG 166/BA	250,00

CARICABATTERIE PER FG 166/BA



CODICE	€/PZ
FG 166/CB	70,00

SET PRESSORI PER AMMORTIZZATORI

Dotato di 2 coppie di barre filettate



CODICE	L/mm max	€/PZ
FG 159/PM	65-200/65-370	230,00

SET 5 CHIAVI PER GHIERE AMMORTIZZATORI



CODICE	Contenuto	€/PZ
FG 159/S5	10.5x3.5, 12.5x3.5, 14x2.5, 14x3, 14.5x5	57,00

CHIAVE A BUSSOLA PER SNODI SFERICI PSA



CODICE	Ø/mm	●/mm	€/PZ
FG 169/A44	44	38	57,00

UTENSILE DIVARICATORE UNIVERSALE

Elevata capacità
 Utilizzo universale
 Superfici di pressione parallele

NEW



CODICE	Capacità	€/PZ
FG 168/GA	5 - 11,5 mm	60,00



ESTRATTORE PER SNODI SFERICI



CODICE	L1/mm	L2/mm	L3/mm	€/PZ
FG 168/E	55	25	23.5	98,00

ESTRATTORE PER SNODI SFERICI



CODICE	Ømm	€/PZ
FG 168/1	18	54,00
FG 168/2	25	67,00
FG 168/3	30	102,00
FG 168/4	40	135,00

ESTRATTORE A PERCUSSIONE PER SNODI SFERICI



CODICE	L/mm	€/PZ
FG 169/FO1	18	44,50
FG 169/FO2	23	44,50
FG 169/FO3	30	44,50

ESTRATTORE REGOLABILE PER SNODI SFERICI



CODICE	Ømm	€/PZ
FG 169/1	19	62,00
FG 169/2	22	80,50

ESTRATTORE REGOLABILE PER SNODI SFERICI



CODICE	Ømm	€/PZ
FG 169/3	23	144,50

ESTRATTORE A C PER BOCCOLE E CUSCINETTI

Struttura robusta con telaio in acciaio
Con adattatori per attacco da 1/4", 3/8", 1/2", 3/4" per l'utilizzo su automobili, furgoni e veicoli commerciali

NEW

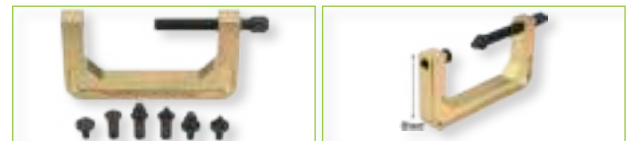

CODICE	Vite mm	H/mm	€/PZ
FG 168/S7	165	89	250,00

ESTRATTORE PER GIUNTI OMCINETICI



CODICE	L1/mm	L2/mm	L3/mm	€/PZ
FG 165/G01	250	104	32	180,00

UTENSILE PER SMONTAGGIO GIUNTI OMCINETICI



CODICE	L1/mm	L2/mm	€/PZ
FG 165/G02	55	400	150,00

UTENSILE PER MONTAGGIO E SMONTAGGIO BRACCETTI STERZO



CODICE	Ømm	Ømm esterno	●/mm	L/mm	€/PZ
FG 169/BS	35-45	89	1/2" o 27	400	129,00
FG 169/BS1	28-35	73	1/2" o 27	400	118,50
FG 169/BS3	35-45	89	1/2" o 27	195	118,50

SET UTENSILI SPECIALI PER MONTAGGIO/SMONTAGGIO SILENT BLOCK



CODICE	Contenuto	€/PZ
FG 165/S26	Boccole per Ø 44-82mm, 4 barre filettate M10, M12, M14, M16	700,00

ESTRATTORE CON VITE IDRAULICA PER MOZZI E CUSCINETTI RUOTE 3,4,5 FORI

Piastra a 10 fori
Per mozzi fino a M12



CODICE	€/PZ
FG 198/DF	360,00

SET MONTAGGIO/SMONTAGGIO SILENT BLOCK FIAT PANDA 4X4 E PANDA METANO



CODICE	€/PZ
FG 165/S7	195,00

SET PER MONTAGGIO/SMONTAGGIO CUSCINETTI RUOTA

Smontaggio Ø 34-45mm
Montaggio Ø 60-84mm

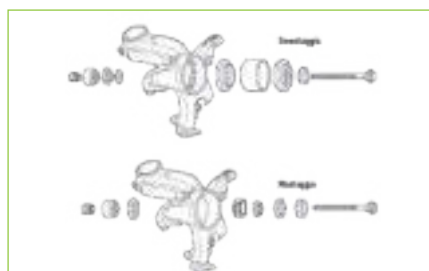

CODICE	smontaggio Ømm	montaggio Ømm	€/PZ
FG 166/S28	34-45	60-84	475,00

SET PER ESTRAZIONE GHIERA CUSCINETTI

Pinze: Ø 40-45mm, 45-51mm, 50-55mm, 55-61mm
Chiavi serraggio ghiera: Ø 82.7mm, 58.9mm



CODICE	€/PZ
FG 166/S7	650,00

SET CON AGGRAFFATRICE E CONNETTOTTI WEATHER-PACK



CODICE	€/PZ
FG 185/S190	154,50



PINZA RIMOZIONE PIOLI CATENE



CODICE	€/PZ
FG 172/TC	56,00

PINZA PER FASCETTE A SCATTO CLIC



CODICE	€/PZ
FG 172/CL	48,50

PINZA PER FASCETTE A SCATTO CLIC



CODICE	€/PZ
FG 172/FA	72,50

PINZA A CRICCHETTO PER FASCETTE MANICOTTI

Funzione bloccaggio morsetti a cricchetto
Apertura con meccanismo a molla

NEW



CODICE	Capacità	€/PZ
FG 172/FA2	0-65 mm	98,00

PINZA PER FASCETTE A SCATTO CLIC

Con ganasce multipresa regolabili

NEW



CODICE	mm	gr	€/PZ
FG 172/MA	220	240	98,00

PINZA PER ANELLI STRINGITUBO CON PROLUNGA INTERCambiabile



CODICE	Apertura mm mm	€/PZ
FG 172/AS2	3-52	108,00

PROLUNGHE DI RICAMBIO



CODICE	Apertura mm mm	€/PZ
FG 172/AS2-A	3-52	26,00
FG 172/AS2-B	0 - 75	50,00
FG 172/AS2-C	0 - 24	30,00
FG 172/AS2-D	Per connettori carburante	33,00

PINZA PER COLLARI OETIKER



CODICE	€/PZ
FG 172/G02	105,00

PINZA PER COLLARI OETIKER



CODICE	€/PZ
FG 172/OT	56,00

PINZA PER SERRAGGIO E TAGLIO FASCETTE A NASTRO IN ACCIAIO INOX

Indicata anche per fascette Panduit



CODICE	Ømm	€/PZ
FG 172/PA	4.7 - 9.5	67,00

PINZA PER RIMOZIONE TUBI ACQUA E CARBURANTE



CODICE	€/PZ
FG 172/TG	49,50

PINZE IN PLASTICA PER OCCLUSIONE TUBI E MANICOTTI



CODICE	Ømm	€/PZ
FG 170/1	8-15	14,00
FG 170/2	15-25	16,00
FG 170/3	25-45	18,50

SET 3 PINZE PER OCCLUSIONE TUBI



CODICE	€/PZ
FG 170/S3	49,50

PINZA RACCORDI RAPIDI TUBO CARBURANTE



CODICE	€/PZ
FG 171/N	30,00



PINZA RACCORDI RAPIDI TUBO CARBURANTE



CODICE	€/PZ
FG 171/B	41,50

PINZA RACCORDI RAPIDI TUBO CARBURANTE CON TESTA FLESSIBILE



CODICE	€/PZ
FG 171/FL	51,50

PINZA RACCORDI RAPIDI TUBO CARBURANTE

Per Multijet



CODICE	€/PZ
FG 172/MJ	26,00

KIT UTENSILI PER SGANCIO RACCORDI FILTRI GASOLIO



CODICE	€/PZ
FG 172/S4	50,00

PINZA PER ANELLI TENUTA VALVOLE



CODICE	L/mm	€/PZ
FG 174	270	39,50

PINZA PER CAPPUCCI CANDELE



CODICE	Ømm	L/mm	€/PZ
FG 172/CA	14	290	58,00

UTENSILE PER REGOLAZIONE UGELLI TERGICRISTALLO OPEL



CODICE	€/PZ
FG 195/U	11,00

CHIAVE PER SMONTAGGIO TURBINE



CODICE	mm	€/PZ
FG 196/A12	22	27,00

PINZA PER ESTRAZIONE RELÉ



CODICE	Ømm	€/PZ
FG 172/RL2	15-50	25,00

AVVIATORE

Batteria ermetica al piombo (AGM)
Alimentazione 220V e accendisigari 12 V



CE

CODICE	Volt	Corrente di spunto	€/PZ
FG 99	12	2000AA	550,00
FG 99/B	12	2500AA	670,00

AVVIATORE

Batteria ermetica al piombo (AGM)
Alimentazione 220V e accendisigari 12 V



CE

CODICE	Volt	Corrente di spunto	€/PZ
FG 99/C	12-24	5000 (12V) - 2500 (24V)	1.900,00

AVVIATORE PORTATILE MULTIFUNZIONE

Adatto per l'avviamento di emergenza di motori con batteria da 12V
Display LCD
2 uscite USB 5V 2.4A
Cavo 12V 10A per presa accendisigari in dotazione
Led con 5 modalità
3 modalità di ricarica (in dotazione: caricabatterie, cavo USB tipo C, adattatore 14V 1A per presa accendisigari)
Funzione Power Bank
Funzione Travel Lock
In dotazione boost con morsetti per avviamento motore, custodia

NEW



CE

CODICE	Corrente di spunto	Capacità batteria	€/PZ
FG 97/LT	800 A	18000 mAh	250,00

CARICABATTERIE E MANTENITORE DI CARICA 6/12/24V

Utilizzabile con tutti i tipi di batterie, sia al piombo acido che al litio
Display LCD
8 fasi di ricarica
Funzione WINTER (ciclo di carica ottimizzato in presenza di basse temperature)
Funzione JUMP (ricarica per batterie molto scariche)
Indicatore del livello di carica
Identificazione delle batterie esauste
Funzione di recupero batterie scariche per batterie al piombo acido
Protezione da surriscaldamento, inversione di polarità, corto circuito
In dotazione cavo con pinze
Dimensione 200x120 mm - Peso 1300gr

NEW



CE

CODICE	Max corrente carica	Capacità di carica	€/PZ
FG 98/A15	15 A (6V e 12V) 8A (24V)	150 Ah	280,00

CARICABATTERIE E MANTENITORE DI CARICA 6/12V

Utilizzabile con tutti i tipi di batterie, sia al piombo acido che al litio
Display LCD
Funzione WINTER (ciclo di carica ottimizzato in presenza di basse temperature)
Indicatore del livello di carica
Identificazione delle batterie esauste
Protezione da surriscaldamento, inversione di polarità, corto circuito
In dotazione cavo con pinze e cavo con occhielli
Dimensione 200x76 mm - Peso 460gr

NEW



CE

CODICE	Max corrente carica	Capacità di carica	€/PZ
FG 98/A6	6 A	8-100 Ah	120,00

CARICABATTERIE E MANTENITORE DI CARICA 6/12V

Utilizzabile con tutti i tipi di batterie, sia al piombo acido che al litio
Indicatore del livello di carica
Protezione da surriscaldamento, inversione di polarità, corto circuito
In dotazione cavo con pinze e cavo con occhielli
Dimensione 71x116 - Peso 170gr

NEW



CE

CODICE	Max corrente carica	Capacità di carica	€/PZ
FG 98/A1	1 A	8-30 Ah	65,00



SET SERVICE PER AUTOFFICINA



CODICE	€/PZ
FG 141010	320,00

RICAMBI PER SET SERVICE AUTOFFICINA

CODICE	Descrizione	€/PZ
FG 141015	Bobina 50 coprisedili	90,00
FG 141065	Confezione 50 tappetini 450x350mm	32,00
FG 141060-BO	Bobina coprivolante	11,00
FG 141060-MA	Manopola per bobina coprivolante	13,00

CHIAVE POLIGONALE PER DADI TENDICINGHIA



CODICE	Ømm	€/PZ
FG 184/B13	13	29,00
FG 184/B15	15	29,00
FG 184/B16	16	29,00
FG 184/B17	17	29,00
FG 184/B19	19	29,00

CHIAVE PER DADI TENDICINGHIA FIAT, FORD, CITROEN, PEUGEOT



CODICE	€/PZ
FG 184/FT1	70,00

SET 5 CHIAVI PER DADI TENDICINGHIA



Torx

CODICE	Contenuto	€/PZ
FG 184/S5	13,15,16,17,19mm	155,00

SET CHIAVE TENDICINGHIA CON INSERTI MASCHIO



CODICE	Contenuto	€/PZ
FG 184/S6	TX40, TX45, TX60, H8, H10	95,00

ESTRATTORE PER PULEGGE MULTIGOLA



CODICE	Capacità mm	Passo gola mm	€/PZ
FG 181/PM	30-157	3.56	152,50

ESTRATTORE UNIVERSALE PER PULEGGE



CODICE	€/PZ
FG 181/PM2	93,00

TESTER DIGITALE PROVA COMPRESIONE

Grado di precisione: 1%FS
Software in 8 lingue (IT, EN, DE, FR, ES, PT, GR, PL)
Display touch screen LCD retroilluminato a colori, 4.3"
Sensore di pressione 0-80 Bar
Morsetti collegamento a batteria 12V
Kit raccordi e tubo per sistemi benzina
Tubazione per attacchi sistemi Diesel



Accessori di base in dotazione



CODICE

FG 215

€/PZ

950,00

TESTER PROVA COMPRESIONE DIGITALE CON FINITI INIETTORI E FINTE CANDELETTE PER SISTEMI DIESEL



CODICE

FG 215/S40

€/PZ

1.550,00

FG 215 è un tester digitale in grado di misurare la compressione dei sistemi ad alimentazione Diesel e Benzina. Ideato, ingegnerizzato e prodotto interamente in Italia, rappresenta una vera rivoluzione tecnologica!

**Funzione
PROVA ALTERNATORE**



**Schermata principale
FG 215**



**Funzione
PROVA COMPRESIONE
E TENSIONE BATTERIA**

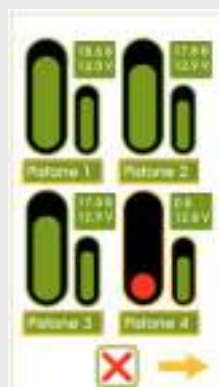

Possibilità di memorizzare e scaricare le prove su PC, personalizzando la scheda dati con tutte le informazioni del cliente della propria autofficina (incluso il logo)



SET FINTI INIETTORI E FINTE CANDELETTE PER SISTEMI DIESEL AUTO, VEICOLI COMMERCIALI E MEZZI PESANTI



CODICE	€/PZ
FG 215/S39	600,00

ATTACCHI PER FINTE CANDELETTE



CODICE	Misura	L/mm	€/PZ
FG 215/CA1	12x1.25	17.5	26,00
FG 215/CA2	12x1.25	20.0.0	27,00
FG 215/CA3	10x1.25	28.5	27,00
FG 215/CA4	10x1.25	42.0	30,00
FG 215/CA5	10x1.25	45.0	30,00
FG 215/CA6	10x1.25	44.0	30,00
FG 215/CA7	10x1.0	54.0	30,00
FG 215/CA8	10x1.0	43.0	30,00
FG 215/CA9	12x1.25	26.0	30,00
FG 215/CA10	10x1.25	32.0	32,00
FG 215/CA11	10x1.0	35.0	32,00
FG 215/CA12	12x1.25	58.0	33,00
FG 215/CA13	10x1.0	71.0	34,00
FG 215/CA14	10x1.0	59.0	35,00
FG 215/CA15	8x1.0	61.0	35,00
FG 215/CA16	10x1.25	85.0	40,00
FG 215/CA17	10x1.0	80.0	55,00
FG 215/CA19	10x1.25	102.0	56,00
FG 215/CA20	9x1.0	88.0	40,00
FG 215/CA21	10x1.25	85.0	55,00
FG 215/CA22	10x1.0	73.0	52,00

ADATTATORE 90°



CODICE	€/PZ
FG 215/AD90	33,00

TUBO PER INNESTO RAPIDO PER MOTORI DIESEL



CODICE	€/PZ
FG 215/TU	105,00

ATTACCHI PER FINTI INIETTORI



CODICE	Misura	L/mm	€/PZ
FG 215/FI23	22x1.5	43.0	42,00
FG 215/FI24	24x1.5	28.0	48,00
FG 215/FI25	20x1.5	29.0	54,00
FG 215/FI26	24x2.0	26.0	55,00

SET ADATTATORI PER MEZZI PESANTI, MARINA E AGRICOLTURA



CODICE	€/PZ
FG 215MP/S9	195,00

TUBO PER RACCORDI BENZINA



CODICE	€/PZ
FG 215TU/BE	46,00

FINTE CANDELE PER VEICOLI BENZINA



CODICE	Misura	€/PZ
FG 215BE/M10	M10	11,00
FG 215BE/M12	M12	11,00
FG 215BE/M14	M14	11,00
FG 215BE/M14F	M14 - Ford Zetec	22,00
FG 215BE/M16	M16	11,00
FG 215BE/PR	Prolunga universale	70,00

TESTER MULTI-FUNZIONE PER PROVA COMPRESSIONE PROVA PRESSIONE CARBURANTI E PRESSIONE OLIO MOTORE

Grado di precisione: 1%FS

Software in 8 lingue (IT, EN, DE, FR, ES, PT, GR, PL)

Display touch screen LCD retroilluminato a colori, 4.3"

2 sensori di pressione (0-80 Bar e 0.2500 Bar)



CODICE	€/PZ
FG 219/S	3.350,00

TESTER DIGITALE PER BATTERIE 12V E 24V

Tensione di funzionamento: da 9V a 35V DC

Tempo di verifica della batteria: circa 1 minuto

Batteria interna per memoria data/ora: CR1220 (1 pezzo)



CODICE	Misure mm	Lunghezza cavi mm	€/PZ
FG 220/BT	90x50x235	570	420,00

SCHERMATA PRINCIPALE FG 219



CARATTERISTICHE:	DISPLAY RETROILLUMINATO
	SOFTWARE 6 LINGUE: italiano; inglese; spagnolo; polacco; tedesco; francese
	STAMPANTE INTEGRATA CON ROTOLO DI CARTA TERMICA
	SISTEMA RILEVAZIONE FALSO CONTATTO COLLEGAMENTO PINZE
APPLICAZIONI:	TEST BATTERIE 12 E 24V
	TEST ALTERNATORE (INTELLIGENTE E NORMALE) 12-24V CARICA
	TEST SISTEMA DI AVVIAMENTO
BATTERIE SUPPORTATE:	PB, WET, GEL AGM, AGM FLAT, EFB
APPLICAZIONI:	CCA: 100-1700; IEC: 100-1000; EN: 100-1700; DIN: 100-1000; JIS
LUNGHEZZA DEI CAVI:	570 mm



FASATURA MOTORE 2024



**169
KIT**

UNA DISPONIBILITÀ DI OLTRE
169 DIVERSI KIT FASATURA
per rispondere ad esigenze
professionali specifiche

**+4
NUOVI
KIT**

DEDICATI AI NUOVI MOTORI:
1.5 E 2.0 BMW DIESEL
1.3 BENZINA MERCEDES-BENZ
1.6 E 2.0 DIESEL MERCEDES-BENZ
ATTREZZO COMPRESIONE PIATTELLI MODULO MULTIAIR (3 CIL.)



SET FASATURA MOTORI BMW N47, N47S, N57 A CATENA

Modelli: 118D(E81/E87);120D(E81/E82/E87);
123D(E81/E82/E87); 318D(E90/E91);
320D(E90/E91/E92); 520D(E60/E); X3 2.0D(E83)
Cilindrata: 1.6D, 2.0D, 3.0D
Codice motore: N47, N47S, N57



CODICE	€/PZ
FG 192/BW4	188,00

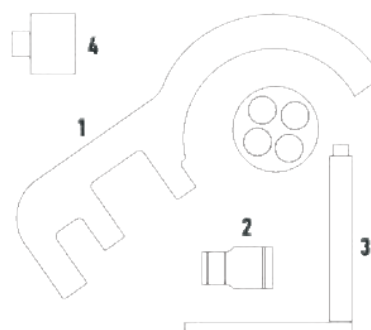

CODICE	n°	Descrizione	€/PZ
FG 192/BW4-1	1	Attrezzo di allineamento alberi a camme	69,80
FG 192/BW4-2	2	Attrezzo per la rotazione puleggia albero motore	58,20
FG 192/BW4-3	3	Perno di fasatura volano/piastra di comando	17,50
FG 192/BW4-4	4	Attrezzo smontaggio pignone pompa carburante alta pressione	32,00

UTENSILE PER BLOCCAGGIO ALBERO MOTORE BMW N47, N47S, N57

Modelli: 118D(E81/E87);120D(E81/E82/E87);123D(E81/E82/E87);
318D(E90/E91); 320D(E90/E91/E92); 520D(E60/E); X3 2.0D(E83)
Cilindrata: 1.6D, 2.0D, 3.0D
Codice motore: N47, N47S, N57



CODICE	€/PZ
FG 192/BW3	56,00

ATTREZZO DI BLOCCAGGIO DELL'ALBERO MOTORE PER BMW/MINI N47/N47T/N47S (DAL 5/2013 IN POI)

Modelli: BMW: 114d; 116d; 316d; sdrive16d; 118d; 118d/xdrive; 218d;
sdrive18d; xdrive18d; 318d; 318d/xdrive;
MINI: Clubman; Countryman; Mini; Cooper D; Clubvan; Paceman; Cooper Sd
Cilindrata: 1.6 Diesel; 2.0 Diesel
Codice motore: N47 C16K1 - N47 D16C - N47 C20K1 - N47 C16U1 - N47 C16A/U1 -
N47 D20C/K1 - N47 D20C - N47 D20A - N47 C20U1 - N47 C20A/K1



CODICE	€/PZ
FG 192/BW4E	96,00

**ATTREZZO DI BLOCCAGGIO DELL'ALBERO EQUILIBRATORE
MOTORI BMW E MINI B47, B48**



Modelli: BMW: Serie 1, Serie 2 Active Tourer, Serie 2 Cabriolet, Serie 2 Coupe, Serie 2 Gran Tourer, Serie 3, Serie 3 Gran Turismo, Serie 4 Cabriolet, Serie 4 Coupe, Serie 4 Gran Coupe, Serie 5, X1, X3, X4, X5
MINI: Clubman, Mini Hatch, Clubman, Convertible, Countryman
Cilindrata: 2.0 D; 2.0 benzina
Codice motore: 2.0 D: B47; B47 C20A; B47 C20B; B47 D20A; B47 D20B 2.0 benzina: B48 A20A; B48 A20B; B48 B20A; B48 B20B



CODICE	€/PZ
FG 192/BW16	250,00

**SET FASATURA INGRANAGGI ALBERO EQUILIBRATORE
MOTORI BMW (N47/N47S)**



Modelli: 118D(E81/E87); 120D(E81/E82/E87); 123D(E81/E82/E87); 318D(E90/E91); 320D(E90/E91/E92); 520D(E60/E); X3 2.0D(E83)
Cilindrata: 1.6D, 2.0D
Codice motore: N47, N47S



CODICE	€/PZ
FG 192/BW4B	350,00

ESTRATTORE PULEGGIA POMPA INIEZIONE BMW

Codice motore: M41, M51



CODICE	€/PZ
FG 192/BW1	44,00

ESTRATTORE PULEGGIA POMPA INIEZIONE BMW

Codice motore: M47, M47TU, M57, M57TU



CODICE	€/PZ
FG 192/BW2	57,00

**SET FASATURA MOTORI BMW-MINI B37/B47 1.5, 2.0
DIESEL (CATENA DELLA DISTRIBUZIONE)**



Modelli: BMW: 214d; 216d; sDrive 16d; 114d; 116d; xDrive25d; 218d; 220d; sDrive 18d; xDrive 18d; xDrive 20d; 316d; 318d; 418d; 420d; 518d; 225d;
MINI: Mini Hatch; One D; Convertible; Cooper D; Cooper SD
Cilindrata: 1.5, 2.0
Codice motore: B37 C15A; B37 D15A; B47 C20A; B47; B47 D20A; B47 D20B



CODICE	€/PZ
FG 192/BW9B	480,00

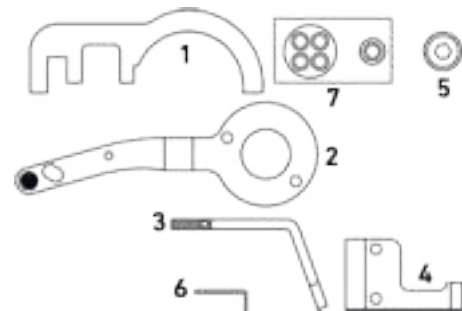

CODICE	n°	Descrizione	€/PZ
FG 192/BW4-1	1	Attrezzo di allineamento albero a camme	69,80
FG 192/BW9B-2	2	Attrezzo di bloccaggio albero motore	140,00
FG 192/BW9B-3	3	Perno di fasatura volano/piastra di comando	30,00
FG 192/BW9B-4	4	Cambio automatico: Adattatore per perno di fasatura piastra di comando	120,00
FG 192/BW4-4	5	Attrezzo smontaggio pignone pompa carburante ad alta pressione	32,00
FG 192/BW9B-6	6	Perno di bloccaggio tendicatena	5,00
FG 192/BW4-2	7	Attrezzo di rotazione puleggia albero motore	58,20



KIT ROTAZIONE ALBERO MOTORE E FERMO VOLANO BMW-MINI B37/B47 1.5, 2.0 DIESEL



CODICE

FG 192/BW4C

€/PZ

145,00

ATTREZZO DI BLOCCAGGIO DELL'ALBERO MOTORE PER BMW B57

Modelli: MW B57. BMW:X5;X4;X3;Serie 5;Serie 6;Serie 7;Serie 8
Cilindrata: 1.5 Diesel; 2.0 Diesel
Codici motore: B57D30A; B57D30B; B57D30C

NEW



CODICE

FG 192/BW9C

€/PZ

65,00

SET FASATURA MOTORI BMW M47/M57 LAND ROVER 2.0 - 3.0 DIESEL TD4/TD6; OPEL 2.5 D

Modelli: BMW M47/M47TU: 120d, 318d, 318td Compact, 320d, 520d, X3
BMW M57/M57TU: 330d, 335d, 530d, 535d, 635d, 730d, X3, X5, X5D Turbo, X6
LAND ROVER: Freelander (Td4) 2000-2006; Range Rover: Td6 (02-13)
VAUXHALL/OPEL: Omega-B (01-03)

Cilindrata: 2.0; 2.5; 3.0 Diesel

Codice motore: M47: 20 4D 1; M47TU: 20 4D 4 / M57: 306D1; M57: YD30T2,
204D3TD4 / M57TU: 306D2, 306D5, 306D1 / TD6: Y25DT



CODICE

FG 192/BW5

€/PZ

190,00

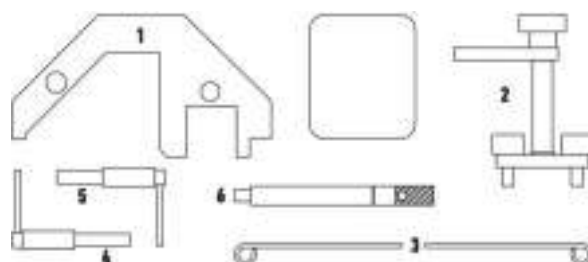

CODICE

FG 192/BW5-1

n°

1

Descrizione

Attrezzo di allineamento albero a camme

€/PZ

56,70

FG 192/BW5-2

2

Attrezzo di bloccaggio albero a camme

47,30

FG 192/BW5-3

3

Perni di bloccaggio tendicatena (2 pz)

9,00

FG 192/BW5-4

4

Perno di fasatura volano 1

11,00

FG 192/BW5-5

5

Perno di fasatura volano 2

11,00

FG 192/BW5-6

6

Perno di fasatura volano

15,80

SET FASATURA MOTORI BMW-MINI B38/B48/B58 1.5, 2.0, 3.0 (CATENA DELLA DISTRIBUZIONE)

Modelli: BMW: 116i; 118i; 225xe; 218i; 220i; 225i; 120i; 125i; 320i; 330i;
420i; 430i; 530i; 520i; 730i; 740e iPerformance; sDrive 20i; xDrive 25i; 214d; 216d;
sDrive 16d; 114d; xDrive25d; 218d; 220d; sDrive 18d; xDrive 18d; xDrive 20d; 316d;
318d; 418d; 420d; 518d; 225d; MINI: Mini Hatch; One D; Convertible; Cooper D

Cilindrata: 1.5, 2.0

Codice motore: B38 A15A; B38 B15A; B38 K15A; B48 A20B; B48 B20A; B48 B20B; B48
A20A; B38 A12A



CODICE

FG 192/BW15

€/PZ

900,00

CHIAVE A BUSSOLA PER REGOLAZIONE DISPOSITIVO DI REGISTRAZIONE DELL'ALBERO A CAMME BMW/MINI B38/B48

Modelli: BMW: 116i; 118i; 225xe; 218i; 220i; 225i; 120i; 125i; 320i; 330i;
420i; 430i; 530i; 520i; 730i; 740e iPerformance; sDrive 20i; xDrive 25i; 214d; 216d;
sDrive 16d; 114d; xDrive25d; 218d; 220d; sDrive 18d; xDrive 18d; xDrive 20d; 316d;
318d; 418d; 420d; 518d; 225d; MINI: Mini Hatch; One D; Convertible; Cooper D

Cilindrata: 1.5, 2.0

Codice motore: B38 A15A; B38 B15A; B38 K15A; B48 A20B; B48 B20A; B48 B20B; B48
A20A; B38 A12A



CODICE

FG 192/BW15A

€/PZ

35,00

SET FASATURA MOTORI BMW N40, N45

Modelli: N40: (E46) 316i/316ti/316Ci; N45: (E81/E87) 116i; (E90) 316i

Cilindrata: 1.6

Codice motore: N40 B16A; N45TB16AC, N45B16A



CODICE	€/PZ
FG 192/BW6	410,00

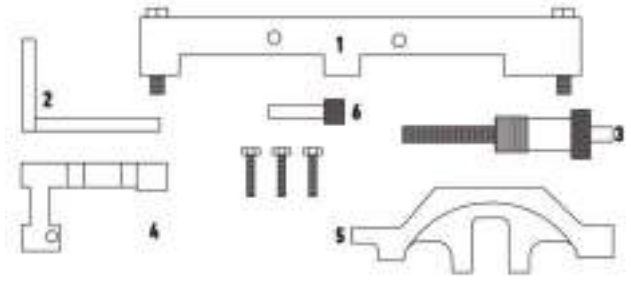

CODICE	n°	Descrizione	€/PZ
FG 192/BW6-1	1	Attrezzo di allineamento ingranaggio sensore	159,40
FG 192/BW8-2	2	Perno di fasatura volano	97,60
FG 192/MI10-4	3	Attrezzo pretensionamento catena distribuzione	32,50
FG 192/BW6-4	4	Attrezzo allineamento albero a camme aspirazione	153,80
FG 192/BW6-5	5	Attrezzo allineamento albero a camme scarico	195,80
FG 192/BW6-6	6	Vite fissaggio per blocco di fissaggio alberi a camme di scarico	11,20

SET FASATURA MOTORI BMW N42, N46, N46T

Modelli: N42: (E46) 316i / 316ti / 318ti/318i N46: (E87) 118i / 120i; (E90/ E91) 318i/320i; Z4 (E85)

Cilindrata: 1.8, 2.0

Codice motore: N42 B18A; N42 B20A; N46 B18; N46 B20; N46 B20B



CODICE	€/PZ
FG 192/BW8	430,00

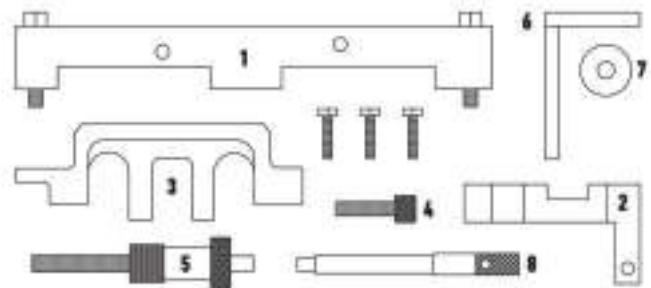

CODICE	n°	Descrizione	€/PZ
FG 192/BW8-1	1	Attrezzo allineamento ingranaggio sensore	119,30
FG 192/BW8-2	2	Attrezzo allineamento albero a camme aspirazione	97,60
FG 192/BW8-3	3	Attrezzo allineamento albero a camme scarico	135,60
FG 192/BW8-4	4	Vite fissaggio per blocco di fissaggio alberi a camme di scarico	10,80
FG 192/MI10-4	5	Attrezzo pretensionamento catena distribuzione	32,50
FG 192/BW8-6	6	Perno di fasatura volano 2	13,60
FG 192/BW8-7	7	Perno di fasatura volano 1	21,70
FG 192/BW8-8	8	Perno rotazione albero a camme aspirazione	16,30

SET FASATURA MOTORI BMW VALVETRONIC

Modelli: N42: (E46) 316i / 316ti / 318ti/318i N46: (E87) 118i / 120i; (E90/ E91) 318i/320i; Z4 (E85)

Cilindrata: 1.8, 2.0

Codice motore: N42 B18A; N42 B20A N46 B18; N46 B20; N46 B20B



CODICE	€/PZ
FG 192/BW18	510,00



SET FASATURA MOTORI BMW N62/N73

Modelli: N62: 540i, 545i, 550i (E60/61); 645i, 650i (E63864), 735i, 740i, 745i, 750i (E65/66), X5 (E53/E70), N73: 760i (E65/66)

Cilindrata: 3.6-4.0-4.4-4.8

Codice motore: N62 B40A; N62 B44A; N62 B48B; N62 B36A; N73 B60A

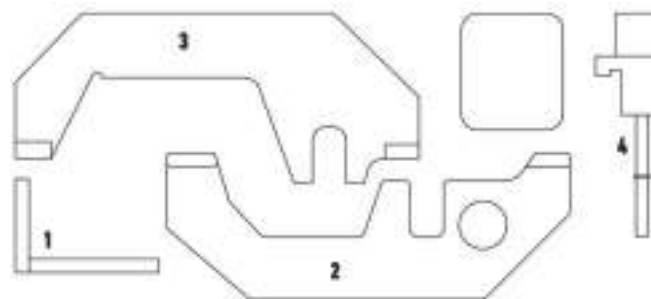

CODICE	€/PZ
FG 192/BW7	358,00

CODICE	n°	Descrizione	€/PZ
FG 192/BW8-6	1	Attrezzo allineamento puleggia albero motore	13,60
FG 192/BW7-2	2	Attrezzo allineamento albero a camme aspirazione	141,00
FG 192/BW7-3	3	Attrezzo allineamento albero a camme scarico	141,00
FG 192/BW7-4	4	Attrezzo di bloccaggio albero a camme	55,10

SET FASATURA MOTORI BMW N43 1.6 & 2.0

Modelli: 116i; 118i; 120i; 316i; 318i; 320i; 520i

Cilindrata: 1.6; 2.0

Codice motore: N43 B16A/AA; N43 B16AA; N43 B20K0; N43 B20AY; N43 B20A; N43 B20AA; N43 B16AA/00; N43 B20U0

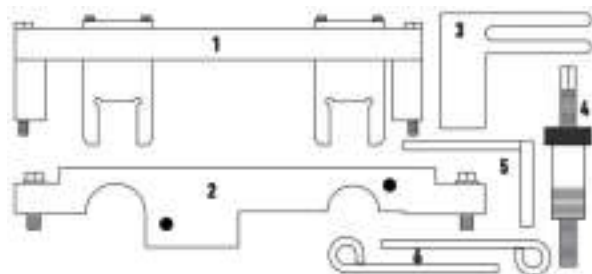

CODICE	€/PZ
FG 192/BW9	600,00

CODICE	n°	Descrizione	€/PZ
FG 192/BW9-1	1	Attrezzo di allineamento albero a camme 1,2,3	297,50
FG 192/BW9-2	2	Attrezzo registrazione disco sensore di posizione albero a camme 1 & 2	158,60
FG 192/BW9-3	3	Attrezzo di allineamento albero equilibratore	35,30
FG 192/MI10-4	4	Attrezzo pretensionamento catena della distribuzione	32,50
FG 192/BW8-6	5	Perno di fasatura volano	13,60
FG 192/BW5-3	6	Perno di bloccaggio tendicatena (2PZ)	9,00

SET FASATURA MOTORI BMW N13 E N18

Modelli: BMW: Serie 1 (114i; 116i; 118i); Serie 3 (316i; 320i)

MINI: Clubman (Cooper S (R55)); Clubman (JCW (R55)); Countryman (Cooper / Cooper S (R60), JWC (R60); Coupe (Cooper S / JCW (R58)); Mini (Cooper S (R56/R87); Paceman (Cooper / JCW (R61)); Roadstar (Cooper S/JCW(R59))

Cilindrata: 1.6 benzina

Codice motore: N13, B16A (cambio manuale), N18 B16A; N18 B16M0; N18 B16C; N18 B16A/M0; N18 B16C/T0

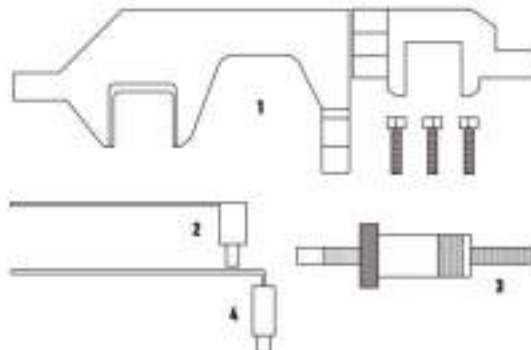

CODICE	€/PZ
FG 192/BW8B	285,00

CODICE	n°	Descrizione	€/PZ
FG 192/BW8B-1	1	Attrezzo allineamento alberi a camme+3 viti	170,00
FG 192/BW8B-2	2	Perno fasatura albero motore (cambio manuale)	15,00
FG 192/MI10-4	3	Attrezzo pretensionamento catena distribuzione	32,50
FG 192/MI10-3	4	Perno fasatura albero motore	12,00

SET FASATURA MOTORI BMW N20 E N26

Modelli: Serie 1 (125i); Serie 3 (320i/xDrive; 328i/xDrive); Serie 5 (520i; 528i/xDrive); X1 (sDrive18i; sDrive20i; xDrive28i); X3 (xDrive20i; xDrive28i); Z4 (sDrive18i; sDrive20i; sDrive28i)

Cilindrata: 2.0 benzina

Codice motore: N20 B20A; N20 B20B/U0; N20; N26 B20



CODICE €/PZ
FG 192/BW8C 420,00

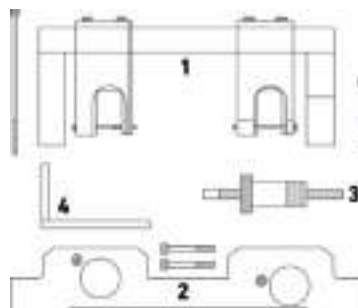

CODICE	n°	Descrizione	€/PZ
FG 192/BW8C-1	1	Attrezzo allineamento alberi a camme	195,00
FG 192/BW8C-2	2	Attrezzo allineamento ingranaggi sensore	106,00
FG 192/MI10-4	3	Attrezzo pretensionamento catena distribuzione	32,50
FG 192/BW8C-4	4	Perno fasatura volano/piastra di comando	16,00

SET FASATURA MOTORI BMW BENZINA M42, M52, M50, M43

Modelli: SERIE 3; SERIE 5; SERIE 7; Z3

Cilindrata: 2.0; 2.5; 2.8

Codice motore: M42; M43; M50; M52



CODICE €/PZ
FG 192/BW10 440,00

SET FASATURA MOTORI BMW BENZINA M52, M54

Modelli: SERIE 3; SERIE 5; SERIE 7; X3; X5; Z3; Z4

Cilindrata: 2.0; 2.2; 2.5; 2.8; 3.0

Codice motore: M52; M54



CODICE €/PZ
FG 192/BW11 680,00

SET FASATURA MOTORI PER BMW BENZINA N51, N52, N53, N54, N55

Modelli: Serie 1; Serie 2; Serie 3; Serie 4; Serie 5; Serie 6; Serie 7; X1; X3; X4; X5; X6; Z4

Cilindrata: 2.5; 3.0

Codice motore: N51; N52; N53; N54; N55



CODICE €/PZ
FG 192/BW19 855,00

SET FASATURA MOTORI ALFA ROMEO 2.2 DIESEL

Modelli: Alfa Romeo: Stelvio; Giulia

Cilindrata: 2.2

Codice motore: 55284529



CODICE €/PZ
FG 192/AF5 120,00



SET FASATURA MOTORI ALFA ROMEO 1.4, 1.6, 1.8 2.0 BENZINA

Modelli: 145, 146, 155, 156, 166, 147, GTV, Spider

Cilindrata: 1.4, 1.6, 1.8, 2.0 benzina

Codice motore: 162.01/323.01; 322,01; 335,03; 676,01; 41,03



CODICE	€/PZ
FG 192/AF4	175,00

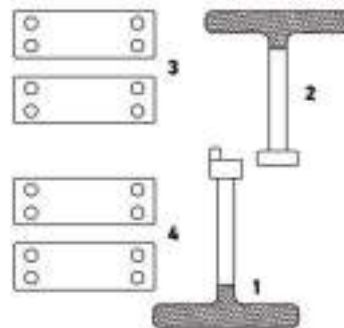

CODICE	n°	Descrizione	€/PZ
FG 192/AF4-1	1	Attrezzo tensionamento cinghia distribuzione	19,00
FG 192/AF4-2	2	Attrezzo di tensionamento cinghia del contralbero	20,20
FG 192/AF4-3	3	Attrezzi di bloccaggio albero a camme motori 1.4	59,30
FG 192/AF4-4	4	Attrezzi di bloccaggio albero a camme motori 1.8, 2.0	59,30

SET FASATURA MOTORI ALFA ROMEO 1.75 TBI

Modelli: 159; BRERA; GIULIETTA; SPIDER. LANCIA: DELTA

Cilindrata: 1,75 TBI; 1,75 DI Turbo

Codice motore: 939B1.000; 940A1.000



CODICE	€/PZ
FG 192/AF4B	270,00

SET FASATURA MOTORI ALFA ROMEO 1.6 ECO 105 HP

Modelli: 147

Cilindrata: 1,6 Eco 105 Hp

Codice motore: 372.03



CODICE	€/PZ
FG 192/AF2	65,00

SET FASATURA MOTORI ALFA ROMEO 2.0 JTS 165 HP

Modelli: GT, 156

Cilindrata: 2.0 JTS

Codice motore: 932A2.000



CODICE	€/PZ
FG 192/AF4C	100,00

SET FASATURA MOTORI 1.0 BENZINA FIAT/JEEP

MODELLI: FIAT: 500X (2018-2022)

JEEP: Renegade (2018-2022)

Cilindrata: 1.0

Codice motore: 55282151



CODICE	€/PZ
FG 192/FT8	175,00

SET FASATURA MOTORI FIAT 1.0 BENZINA

Modelli: 500; 500C; PANDA

Cilindrata: 1.0

Codice motore: 46341162



CODICE	€/PZ
FG 192/FT8C	448,00



ATTREZZO BLOCCAGGIO VOLANO MOTORI FIAT

Modelli:

FIAT: Punto/Punto Classic; Grande Punto; Punto Evo; Palio Weekend; Stilo; Croma; Idea; Multipla; Strada Pick-Up; Marea; Marea Weekend; Sedici; Doblo'; Doblo' Cargo; Linea; Bravo; LANCIA: Lybra; Musa; Delta
ALFA: 145; 146; 147; 156; 159

Cilindrata:

1.8 benzina, 1.6 Multijet, 1.9 JTD - 1.9 Multijet, 2.0, 2.4



CODICE	€/PZ
FG 192/FT1	40,00



SET FASATURA FIAT CROMA, OPEL 2.2 16V

Modelli:

FIAT: CROMA

OPEL: ASTRA, VECTRA, VX220 SPEEDSTER, ZAFIRA, SIGNUM,

Cilindrata: 2.2 16V (benzina a catena)

Codice motore: 194A1.000; Z22SE; Z22YH



CODICE	€/PZ
FG 192/FT3	82,00



ATTREZZO BLOCCAGGIO PIGNONE POMPA DELL'ACQUA MOTORI FIAT CROMA, OPEL

Modelli: FIAT: CROMA

OPEL: ASTRA, VECTRA, VX220 SPEEDSTER, ZAFIRA, SIGNUM,

Cilindrata: 2.2 16V (benzina a catena)

Codice motore: 194A1.000; Z22SE; Z22YH

Permette di rimuovere/installare la pompa dell'acqua senza interferire con la catena di distribuzione



CODICE	€/PZ
FG 192/FT4	88,00



SET FASATURA MOTORI FIAT 1.6 16V

Modelli: Brava; Bravo; Marea; Multipla; Stilo; Palio Weekend

Cilindrata: 1.6 16V

Codice motore: 178B3.000; 182A4.000; 182A6.000; 182B6.000



CODICE	€/PZ
FG 192/FT5	295,00

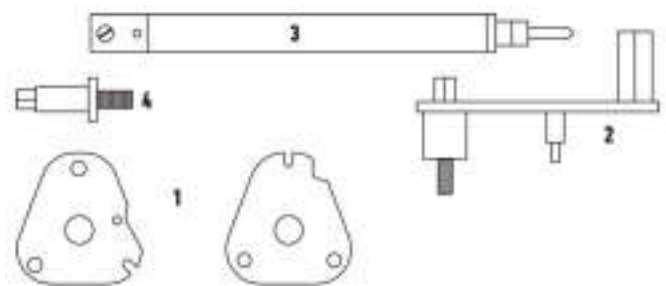

CODICE	n°	Descrizione	€/PZ
FG 192/FT5-1	1	Attrezzi di bloccaggio albero a camme	140,00
FG 192/FT5-2	2	Attrezzo di tensionamento	44,00
FG 192/FT5-3	3	Comparatore (per ricerca del punto morto superiore)	41,20
FG 192/FT5-4	4	Attrezzo di bloccaggio del volano	9,20



ATTREZZO BLOCCAGGIO VOLANO MOTORI FIAT

Modelli: Brava; Bravo; Multipla
Cilindrata: 1.6 16V
Codice motore: 182B6.000, 182A4.000



CODICE	€/PZ
FG 192/FT5A	20,00



SET FASATURA MOTORI FIAT 1.2/1.4 16V

Modelli:
 FIAT: Punto, Brava, Bravo, Marea, Stilo, Palio Weekend
 LANCIA: YPSILON, MUSA
Cilindrata: 1.2 16V, 1.4 16V
Codice motore: 176B9.000; 182B2.000; 188A5.000; 843A1.000



CODICE	€/PZ
FG 192/FT5B	260,00

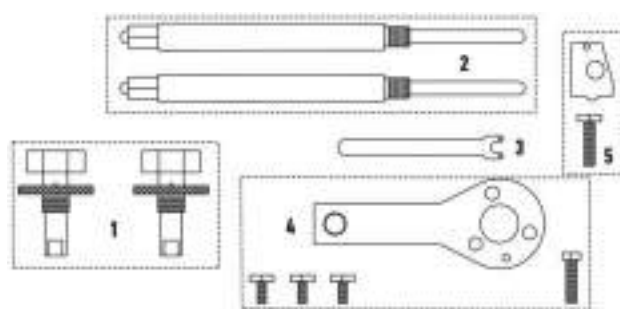

CODICE	n°	Descrizione	€/PZ
FG 192/FT5B-1	1	Attrezzi di bloccaggio albero a camme (2pz)	70,50
FG 192/FT5B-2	2	Attrezzi di posizionamento pistone (2pz)	94,90
FG 192/FT12-1	3	Attrezzo del tendicinghia	9,50
FG 192/FT12-3	4	Attrezzo di bloccaggio albero motore	29,00
FG 192/FT5B-5	5	Attrezzo di bloccaggio del pignone albero a camme	33,90

SET FASATURA MOTORI FIAT, ALFA ROMEO, CHEVROLET, OPEL 1.6, 1.8

Modelli: FIAT: Croma; ALFA ROMEO: 159;
 CHEVROLET: Aveo; Cruze
 OPEL: Corsa; Astra, Meriva, Zara, Vectra, Signum, Insigna
Cilindrata: 1.4, 1.6, 1.8 benzina
Codice motore: 939A4.000; G14D; LXV(F16D4); 2HO(Z18XER); Z16LEL; Z16LER; Z16LET; Z16XE1; Z16XEP; Z16XER; A16XER; A18XER; 2HO/A18XEL



CODICE	€/PZ
FG 192/FT7	182,00

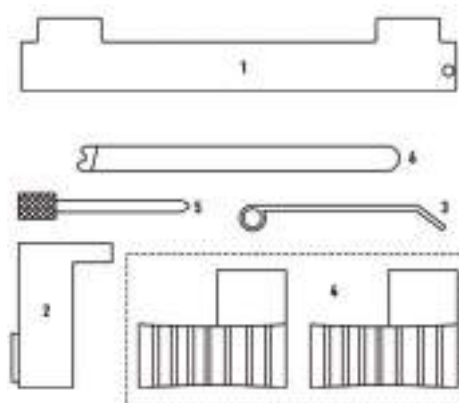

CODICE	n°	Descrizione	€/PZ
FG 192/FT7-1	1	Attrezzo di fasatura alberi a camme	17,80
FG 192/FT7-2	2	Attrezzo bloccaggio volano	17,80
FG 192/FT7-3	3	Perno di bloccaggio della puleggia del tendicinghia	5,10
FG 192/FT7-4	4	Attrezzo bloccaggio pignoni alberi a camme (2 pz)	91,50
FG 192/FT7-5	5	Attrezzo di bloccaggio del tendicinghia della cinghia organi ausiliari	10,20
FG 192/FT7-6	6	Attrezzo di bloccaggio del volano	7,60

SET FASATURA MOTORI FIAT 1.2 8V, 1.4 8V

Modelli:

FIAT 500, Grande Punto, Doblo, Panda EVO2.

LANCIA Musa

Cilindrata: 1.2 8V / 1.4 8V

Codice motore: 169A4.000 - 199A4.000 - 350A1.000

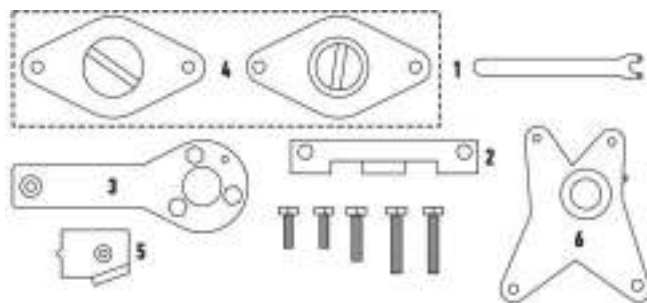

CODICE	€/PZ
FG 192/FT12	320,00

CODICE	n°	Descrizione	€/PZ
FG 192/FT12-1	1	Attrezzo di tensionamento	9,50
FG 192/FT12-2	2	Attrezzo di bloccaggio albero a camme	26,00
FG 192/FT12-3	3	Attrezzo fasatura albero motore	29,00
FG 192/FT12-4	4	Attrezzo allineamento albero a camme	125,00
FG 192/FT12-5	5	Attrezzo bloccaggio pignone albero a camme	15,00
FG 192/FT12-6	6	Dima posizionamento testa cilindri	99,00

SET FASATURA MOTORI FIAT 1.3 MULTIJET, 1.3 CDTI, 1.3 DDIS

Modelli:

FIAT: Panda, Punto, Idea, Doblo. LANCIA: Musa, Ypsilon

OPEL: Agila, Corsa, Combo, Tigra, Meriva, Astra

SUZUKI: Ignis, Swi

Cilindrata: 1.3 Multijet, 1.3 CDTi, 1.3 DDiS

Codice motore: 188A8.000; 188A9.000; 199A2.000; 199A3.000; 169A1.000; 223A9.000; Z13DT; Z13 DTH

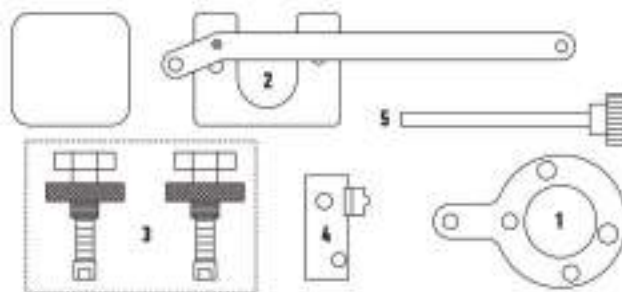

CODICE	€/PZ
FG 192/FT6	250,00

CODICE	n°	Descrizione	€/PZ
FG 192/FT6-1	1	Attrezzo bloccaggio albero motore	35,00
FG 192/FT6-2	2	Attrezzo tendicatena	81,40
FG 192/FT6-3	3	Attrezzo bloccaggio albero a camme (2 pz)	65,00
FG 192/FT6-4	4	Attrezzo bloccaggio volano	42,00
FG 192/FT6-5	5	Perno 8 mm	11,50

COPPIA DI PERNI PER BLOCCAGGIO ALBERO A CAMME MOTORI FIAT 1.3 MULTIJET, 1.3 CDTI

Modelli:

FIAT: 500/500X, Grande Punto, Punto, Doblò, Panda, Idea

OPEL: Corsa-E

Cilindrata: 1.3 Multijet, 1.3 CDTi

Codice motore: 188A8.000; 188A9.000; 199A2.000; 199A3.000; 169A1.000; 223A9.000; LKU/B13DTE; LKV/B13DTC; LKU/B13DTR



CODICE	€/PZ
FG 192/FT2	58,00

ATTREZZO BLOCCAGGIO MOZZO PULEGGIA ALBERO MOTORE E BLOCCAGGIO ALBERO A CAMME PER MOTORI FIAT MULTIJET

Modelli:

Punto; Grande Punto; Punto Evo; Fiorino; Panda/Panda Classic; 500/500C; Doblò; Doblò Cargo; Qubo

Cilindrata: 1.3 JTDM; 1.3 JTDM; 1.3 MultiJet 75;

1.3 MultiJet 85; 1.3 MultiJet 90; 1.3 MultiJet 95

Codice motore: 199A3.000; 199B1.000; 199B4.000; 169A1.000; 223A9.000; 263A2.000



CODICE	€/PZ
FG 192/FT6A	130,00



SET FASATURA MOTORI FIAT, ALFA ROMEO, LANCIA, OPEL 1.6, 1.9, 2.0, 2.4 JTD MULTIJET



Modelli:

ALFA ROMEO: Mito; Giulietta; 145; 147; 156; 166

FIAT: Bravo; Croma; Grande Punto; Punto EVO; Stilo; Doblo'/Doblo' Cargo; Stilo; Multipla; Marea

LANCIA: Delta; Lybra - OPEL: Zara; Vectra; Astra; Insigna - SAAB: 9-3

Cilindrata: 1.6, 1.9, 2.0, 2.4 JTD

Codice motore: 192A5.000; 937A5.000; 192B1.000; 939A2.000; 250A1.000; 182B9.000; 937A2.000; 937A3.000; 939B3.000; 955A4.000; Z19DT; Z19DTH; Z19DTJ; Z19DTL; A19DTR



CODICE

FG 192/FT6B

€/PZ

165,00

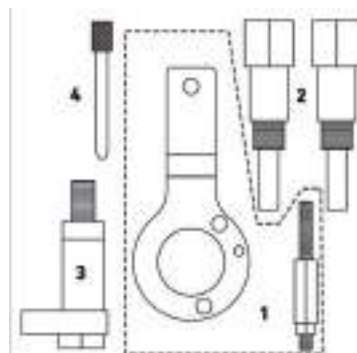

CODICE	n°	Descrizione	€/PZ
FG 192/FT6B-1	1	Attrezzo fasatura albero motore + prigioniero	42,50
FG 192/FT6B-2	2	Attrezzo bloccaggio albero a camme (2 pz)	55,00
FG 192/FT17-4	3	Attrezzo bloccaggio rotazione volano	42,00
FG 192/FT6B-4	4	Perno	6,50

SET FASATURA MOTORI FIAT 2.3JTD

Modelli: FIAT DUCATO, IVECO DAILY

Cilindrata: 2.3D JTD, 2.3D-3.0D Multijet, 2.3D HPI; 3.0 HPI

Codice motore: F1AE0481C; F1AE0481A; F1AE0481B; F1AE0481H; F1AE0481F; F1AE0481G; F1AE0481R; F1AE0481FA; F1AE0481HA; F1AE0481UA; F1AE0481VA; F1AE0481D; F1AE0481N; F1AE0481E; F1CE3481N; F1CE3481M; F1CE0481D; F1CE3481E; F1CE3481A; F1CE3481B; F1CE3481H; F1CE3481F



CODICE

FG 192/FT5C

€/PZ

135,00

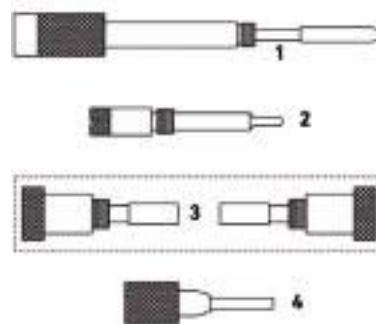

CODICE	n°	Descrizione	€/PZ
FG 192/FT5C-1	1	Perno di fasatura albero motore	36,00
FG 192/FT5C-2	2	Perno di fasatura albero motore	12,00
FG 192/FT5C-3	3	Perno di fasatura albero a camme	45,00
FG 192/FT17-12	4	Perno di allineamento del pignone albero a camme	22,50

ATTREZZO PER IL TENSIONAMENTO CINGHIA DI DISTRIBUZIONE MOTORI JTD MULTIJET

Alfa Romeo: 145, 146, 147, 156, 159, 166, Brera, Giulietta, GT, Mito, Spider
Fiat: 500L, 500X, Brava, Bravo, Croma, Doblo', Ducato, Freemont, Grande Punto, Idea, Marea, Multipla, Punto, Stilo

Lancia: Delta, Kappa, Lybra, Musa, Thesis - Saab: 9-3, 9-5 - Suzuki: SX4

Cilindrata: 1.6 JTD, 1.9 JTD/JTDM; 2.0 JTD; 2.4 JTD; 1.6 D; 2.0 D; 1.9 D; 1.9 CDTI; 2.0 CDTI; 1.9 TiD/TTiD; 2.0 TiD; 2.2 TTiD; 1.9 DDiS



CODICE

FG 192/JTD

€/PZ

90,00

FASANO[®]
TOOLS

SET FASATURA MOTORI FIAT TWINAIR

Modelli: 500/500C (07-); Panda (2012)

Cilindrata: 900 Twinair Turbo

Codice motore: 312A2.000

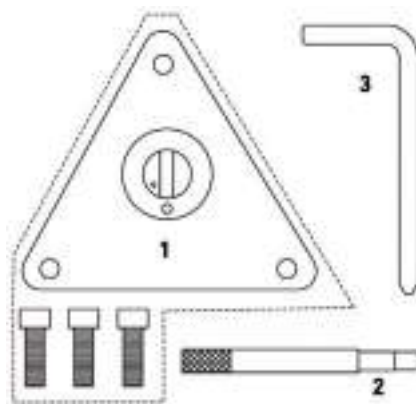

CODICE	€/PZ
FG 192/FT6C	132,00

CODICE	n°	Descrizione	€/PZ
FG 192/FT6C-1	1	Attrezzo fasatura albero a camme lato volano PMS	75,00
FG 192/FT6C-2	2	Fermapuleggia lato distribuzione	19,50
FG 192/FT6C-3	3	Attrezzo di bloccaggio volano/piastra di comando	13,00

ATTREZZO PER ALLINEAMENTO ALBERO EQUILIBRATORE FIAT TWINAIR

Modelli: Ypsilon, 500, 500C, 500L, Punto, Panda, Mito

Cilindrata: 900 Twinair, 900 Twinair Turbo Turbo

Codice motore: 312A5.000, 312A2.000, 199B6.000, 312A7.000



CODICE	€/PZ
FG 192/FT6D	82,00



SET FASATURA MOTORI MULTIAIR

Modelli:

Punto EVO, Punto EVO Abarth, Bravo, 500 Alfa MITO, Giulietta

Cilindrata: 1.4 Multiair 16V

Codice motore: 940A2.000, 955A6.000, 955A2.000, 955A7.000, 955A8.000, 198A7.000

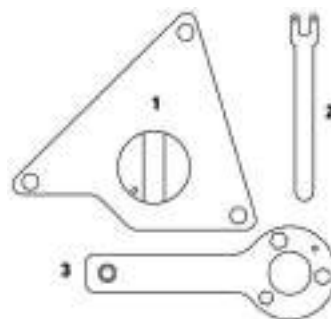

CODICE	€/PZ
FG 192/FT10	150,00

CODICE	n°	Descrizione	€/PZ
FG 192/FT10-1	1	Attrezzo di fasatura albero a camme	82,00
FG 192/FT12-1	2	Attrezzo di bloccaggio albero motore	9,50
FG 192/FT10-3	3	Attrezzo tensionamento cinghia distribuzione	27,00



SET FASATURA MOTORI FIAT TWINAIR E MULTIAIR

Modelli: 500/500C (07-); Panda (2012), Punto EVO, Punto EVO Abarth, Bravo, 500, Alfa MITO, Giulietta

Cilindrata: 900 Twinair Turbo, 1.4 Multiair 16V

Codice motore: 312A2.000, 940A2.000, 955A6.000, 955A2.000, 955A7.000, 955A8.000, 198A7.000



ATTREZZO DI COMPRESSIONE PIATTELLI MODULO MULTIAIR E MULTIAIR TURBO

Modelli: Punto EVO, Punto EVO Abarth, Bravo, 500 Alfa MITO, Giulietta, Lancia Delta

Cilindrata: 1.4 Multiair 16V

Codice motore: 940A2.000, 955A6.000, 955A2.000, 955A7.000, 955A8.000, 198A7.000



CODICE

€/PZ

FG 192/FT16

280,00

CODICE

€/PZ

FG 192/FT10C

370,00

ATTREZZO COMPRESSIONE MOLLE MODULO MULTIAIR (1,4L / 2,4L)

Modelli: FIAT Punto - 500, ALFA ROMEO Mito

Cilindrata: 1.4L, 2.4L

NEW



CODICE

€/PZ

FG 192/FT10D

370,00

FASANO[®]
TOOLS

SET FASATURA FIAT, IVECO, FORD, PEUGEOT, CITROEN

Modelli: FIAT: Ducato, IVECO: Daily, CITROEN: Relay/Jumper III

PEUGEOT: Boxer III, FORD: Transit Van

Cilindrata: 2.2 - 2.3 - 3.0 JTD MJ (catena o cinghia)

Codice motore: 4HU(P22DTE); 4HV(P22DTE);

P8FA; P8FB; QVFA; QWFA; SRFA; SRFB; SRFC; SRFD; SRFE; PGFA; PGFB;

F1AE0481A/B/C/D/E/F/FA/G/H/HA/N/R/UA/VA

F1CE3481A/B/E/F/H/M

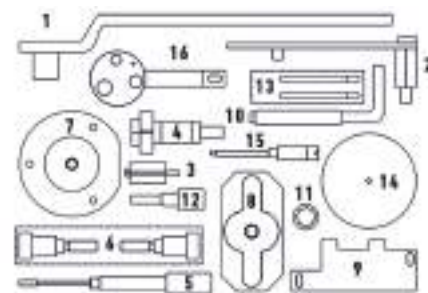

CODICE

€/PZ

FG 192/FT17

680,00

CODICE	n°	Descrizione	€/PZ
FG 192/FT17-1	1	Chiave di reazione su puleggia albero motore 2.2 MJ	95,00
FG 192/FT17-2	2	Attrezzo di allineamento albero motore 2.2MJ	56,00
FG 192/FT17-3	3	Attrezzo ferma volano 2.3 MJ	32,00
FG 192/FT17-4	4	Attrezzo bloccaggio volano 3.0 MJ	42,00
FG 192/FT17-5	5	Perno di fasatura albero motore 2.3-3.0 MJ	29,50
FG 192/FT17-6	6	Perni di fasatura albero a camme 2.3-3.0 MJ	36,50
FG 192/FT17-7	7	Estrattore/introduttore paraolio distribuzione 2.2 MJ	67,00
FG 192/FT17-8	8	Attrezzo di bloccaggio/rotazione albero motore 3.0 MJ	67,00
FG 192/FT17-9	9	Piastra di centraggio pompa dell'olio 2.2 MJ	12,50
FG 192/FT17-10	10	Attrezzo allineamento sensore posizione albero motore 2.2 MJ	18,00
FG 192/FT17-11	11	Bussola per staccare e riattaccare sensore acqua 2.2 MJ	12,50
FG 192/FT17-12	12	Perno allineamento pignone albero a camme 2.3 MJ	22,50
FG 192/FT17-13	13	Perno fasatura del pignone albero a camme 2.2 MJ	29,50
FG 192/FT17-14	14	Introduttore coperchio distribuzione 2.2 MJ	77,00
FG 192/FT17-15	15	Perno di fasatura albero motore 2.3 MJ	10,00
FG 192/FT17-16	16	Attrezzo di allineamento albero motore (2.2 MJ)	40,00

SET FASATURA MOTORI FORD 1.0 ECOBOOST

Modelli: B-MAX; Fiesta; C-MAX; Grand C-MAX; Focus; EcoSport;
Cilindrata: 1.0 EcoBoost; 1.0 SCTi EcoBoost
Codice motore: SFJA; SFJB; M1DA; M2DA; M1JC; M1JE; P4JA; P4JB



CODICE	€/PZ
FG 192/F016	660,00

SET FASATURA MOTORI FORD BENZINA 1.5 ECOBOOST

Modelli: FIESTA; FOCUS; KUGA (2018-2022)
Cilindrata: 1.5 ECOBOOST
Codice motore: Y1DA; YZDA; Y2DA; YZJA



CODICE	€/PZ
FG 192/F016C	298,00

SET FASATURA MOTORI FORD BENZINA 1.2 TI-VCT

Modelli: KA+ (2018-2020)
Cilindrata: 1.2 Ti-VCT
Codice motore: B1KE; ENAP; ENB1



CODICE	€/PZ
FG 192/F02	205,00

KIT SMONTAGGIO/MONTAGGIO DEL BULLONE PUEGGIA ALBERO MOTORE FORD 1.0 ECOBOOST

Modelli: B-MAX; Fiesta; C-MAX; Grand C-MAX; Focus; EcoSport;
Cilindrata: 1.0 EcoBoost; 1.0 SCTi EcoBoost
Codice motore: SFJA; SFJB; M1DA; M2DA; M1JC; M1JE; P4JA; P4JB



CODICE	€/PZ
FG 192/F016A	1.250,00

SET FASATURA MOTORI FORD 2.0 ECOBOOST

Modelli: Focus, Mondeo, Galaxy, S-Max
Cilindrata: 2,0 Ti-VCT; 2,0 SCTi EcoBoost; 2,0 EcoBoost
Codice motore: MGDA; TNBA; TNBB; TNWA; TNWB; TPBA; TPWA; XQDA; R9CB; R9CF; R9CH; TNCC; TNCD; TNCF



CODICE	€/PZ
FG 192/F016B	210,00

SET FASATURA MOTORI FORD 1.4/1.6 TDCI, VOLVO 1.6/2.0, CITROËN 1.6/2.0/2.2 HDI, FIAT 1.6/2.0/2.2 MULTIJET

Modelli: Ford: C-MAX, Fiesta, Focus, Focus, Focus C-MAX
 CITROËN: Dispatch/Jumpy III, C4, C4 Picasso/Grand Picasso, C5 II, C5 III, C6, C8
 FIAT: Scudo
 VOLVO: C30, C70, S40, S80, V50, V70
Codici motore: - G8DA, G8DB, G8DC, G8DD, G8DE, G8DF, HHDA, HHDB, F6JA, F6JB, F6JC, HHJA, HHJB, HHJC, HHJD, HHJE, HHJF
 - 9HU (DV6UTED4), 4HP (DW12BTED4), 4HR (DW12BTED4), 4HR (DW12BTED4), 4HS (DW12BTED4), 4HT (DW12BTED4), RHK (DW10UTED4), RHR (DW10BTED4)
 - 9H07, 9HU (DV6UTED4), RHK (DW10UTED4), RHR (DW10BTED4)
 - D4164T, D4164T DRIVE, D4204T, D4204T2
Cilindrata: 1.4, 1.6 TDCi / 1.6 HDi, 2.0 HDi, 2.2 HDi / 1.6, 2.0, 2.2 Multijet / 1.6, 2.0



CODICE	€/PZ
FG 192/F06	105,00



KIT BLOCCAGGIO ALBERO EQUILBRATORE FORD, LAND ROVER 2.2 D

Modelli:

FORD: Galaxy, S-Max, Mondeo

LAND ROVER: Freelander 2; Range Rover Evoque; Discovery Sport

Cilindrata: 2.2

Codice motore: KNWA; Q4BA; Q4WA; DW12CTED4; 224DT



CODICE

FG 192/FO7C

€/PZ

130,00

ATTREZZO ALLINEAMENTO ALBERO A CAMME MOTORI FORD 1.6 ECOBOOST

Modelli:

B-Max; C-Max; Fiesta; Focus; Galaxy; Gran C-Max; Kuga; Mondeo; S-Max; Tourneo Connect; Transit Connect

Cilindrata: 1.6 ECOBOOST

Codice motore: JQMA; JQMB; JTMA; IQJA; JQDA; IQDA; JTWA; JTWB; KGBA



CODICE

FG 192/FO4A

€/PZ

85,00

SET FASATURA MOTORI FORD 1.25/1.4/1.6 1.6 Ti-VCT (BENZINA), 2.0 TDCI

Modelli:

FORD: C-Max; Gran C-Max; Focus; Fiesta; Mondeo; Kuga; Galaxy; Fusion; S-Max VOLVO: S60; S80; V70

Cilindrata: 1.6 / 1.6 Ti-VCT (benzina); 2.0 TDCI

Codice motore: HXDA; HXDB; SIDA; IQDA; IQDB; PNDA; XTDA; U5JA;

RHBA; G6DA; G6DB; G6DC; G6DD; G6DE; G6DF; IXDA; TXDA; TXDB;

TYDA; UKDA; UKDB; UFWA; F8JA; F8JB; FUJA; FUJB; M7JA; M7JB; SNJA



CODICE

FG 192/FO4

€/PZ

190,00

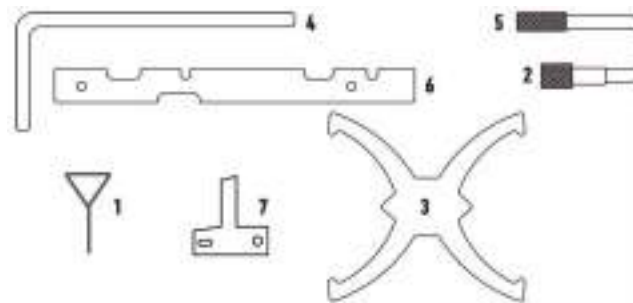

CODICE

FG 192/VW7-5

n°

Descrizione

€/PZ

1 Perno bloccaggio puleggia tendicinghia 7,10

FG 192/FO4-2 2 Perno di fasatura albero motore 16,50

FG 192/FO4-3 3 Attrezzo di bloccaggio dei pignoni alberi a camme 78,00

FG 192/FO4-4 4 Perno di fasatura volante 12,00

FG 192/FO4-5 5 Attrezzo di bloccaggio del pignone albero a camme 8,50

FG 192/FO24-4 6 Attrezzo fasatura albero a camme 12,00

FG 192/FO4-7 7 Attrezzo allineamento puleggia albero motore 22,00

SET FASATURA MOTORI FORD 2.0 ECOBLUE DIESEL TDCI

Modelli:

Transit; Transit Custom; Tourneo Custom

Cilindrata:

2.0 EcoBlue TDCi (dal 2016 in poi)

Codice motore:

YLF6; YLF6; YLR6; YMF6; YMFS; YMR6; YNF6; YNFS; YNR6



CODICE

FG 192/FO15

€/PZ

570,00

KIT RIMOZIONE/INSTALLAZIONE POMPA INIEZIONE MOTORI FORD 2.0 ECOBLUE DIESEL TDCI

Modelli:

Transit; Transit Custom; Tourneo Custom

Cilindrata:

2.0 EcoBlue TDCi (dal 2016 in poi)

Codice motore:

YLF6; YLF6; YLR6; YMF6; YMFS; YMR6; YNF6; YNFS; YNR6



CODICE

FG 192/FO15A

€/PZ

260,00

SET FASATURA MOTORI FORD TRANSIT 2.2 TDCI

Modelli: Ford Transit

Cilindrata: 2.2 TDCI

Codice motore: CYFA; CYFB; DRFA; USR6; SRFA; SRFB;
SRFC; SRFD; SRFE; UHFA; QVFA; QWFA; PGFA; PGFB

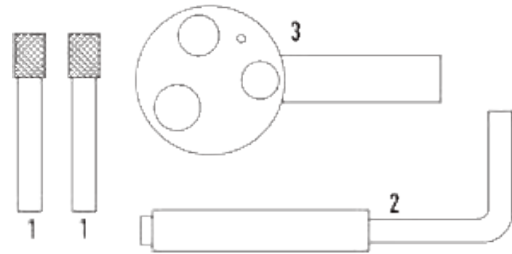

CODICE	€/PZ
FG 192/F07	98,00

CODICE	n°	Descrizione	€/PZ
FG 192/PS15-8	1	Coppia di perni fasatura albero motore (6mm)	15,00
FG 192/F024-20	2	Perno di allineamento albero motore	12,50
FG 192/F07-3	3	Attrezzo bloccaggio puleggia albero motore	52,50

UTENSILE BLOCCAGGIO PULEGGIA ALBERO MOTORE FORD TRANSIT 2.2 TDCI



CODICE	€/PZ
FG 192/F07B	110,00

ATTREZZO BLOCCAGGIO ALBERO MOTORE FORD 2.2 TDCI



Codice motore:

CYRA; CVRA; CVRB; DRRR; DRRB; USRA; USRB



CODICE	€/PZ
FG 192/F07E	35,00



SET FASATURA MOTORI FORD/MAZDA

Modelli:

FORD: C-Max; Courier; Fiesta; Focus; Focus C-Max; Galaxy;
Grand C-Max; S-Max; Mondeo; Tourneo; Transit

MAZDA: 121

Cilindrata:

1.25, 1.4, 1.6, 1.8, 2.0, 2.9, 1.4D, 1.6D, 1.8D, 1.9D, 2.0D, 1.8D Turbo, 1.8 XR2i, 1.8 TDDi,
1.8D TDCi, 1.4D TDCi, 1.6 TDCi, 1.9 TDI, 1.9D TDI PD, 2.0D TDCi, 2.0 SR150, 2.5 DI/
Turbo/TCI

Codice motore:

BHPA; KKDA; HCPA; TZJA; T1DA; C9DC; RTN/RTQ; RTP; DHA; C9DC; UBJA; C9DA/B; FFDA;
F9DA/B; BHDA/B; QYWA; FFWA; ANU; UBJA; CFBA; R3PA; HCPA; HCPB; R2PA; P9PA;
P7PA; R3PA; RWPA; RWPC; BHPA; 4CA; 4CB; 4FD; 4AB; 4BB; 4BA; 4AE; 4GA; DHA



CODICE

€/PZ

FG 192/FO24

290,00

ATTREZZO BLOCCAGGIO VOLANO ADATTO PER MOTORI FORD DIESEL, BENZINA - CINGHIA E CATENA



CODICE

€/PZ

FG 192/FO3

55,00

SET FASATURA MOTORI FORD ZETEC E DURATEC

Modelli: FORD: Fiesta, Fusion, Courier, Escort, Focu, Puma,
Mondeo, Transit, Connect, CougarOrion, Kombi, Galaxy

MAZDA: 121 benzina

VOLVO: S40, V50 benzina

Cilindrata: 1.2,2.4,1.6,1.6 16V, 1.7 16 cinghia, 1.8D, 1.8TD, 1.8 e 2.0 16V
cinghia e catena

Codice motore: DHA, DHB, DHC, DHD, DHE, DHE, DHG, FHA, FHE, 4HA



CODICE

€/PZ

FG 192/FO8

95,00

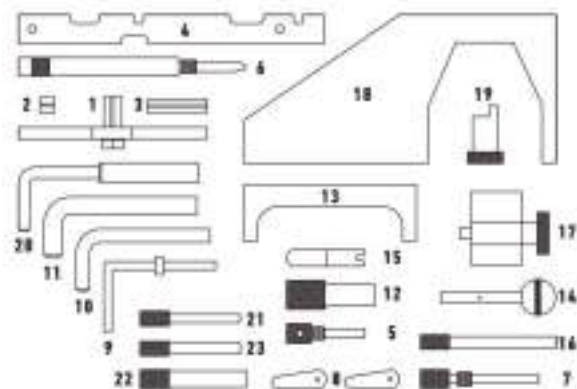

CODICE	n°	Descrizione	€/PZ
FG 192/FO24-1	1	Attrezzo di bloccaggio del volano	41,90
FG 192/FO24-2	2	Adattatore per l'attrezzo di bloccaggio del volano	9,70
FG 192/FO24-3	3	Adattatore per l'attrezzo di bloccaggio del volano	12,90
FG 192/FO24-4	4	Barra di bloccaggio albero a camme	12,00
FG 192/FO24-5	5	Perno di fasatura albero motore	13,00
FG 192/FO24-6	6	Perno di fasatura albero motore	17,50
FG 192/FO24-7	7	Perno di fasatura dell'albero motore	8,30
FG 192/FO24-8	8	Spessori (2 pz)	12,90
FG 192/FO24-9	9	Perno di fasatura dell'albero a camme	12,50
FG 192/FO24-10	10	Perno di fasatura dell'albero a camme	6,20
FG 192/FO24-11	11	Perno di fasatura del volano	6,20
FG 192/FO24-12	12	Perno di bloccaggio del pignone pompa d'iniezione	8,10
FG 192/FO24-13	13	Barra di bloccaggio albero a camme	8,10
FG 192/FO24-14	14	Perno bloccaggio pompa d'iniezione	14,20
FG 192/FO24-15	15	Chiave a due denti	3,20
FG 192/FO24-16	16	Perno di messa a registro	6,40
FG 192/FO24-17	17	Attrezzo di bloccaggio del pignone albero motore	29,00
FG 192/FO24-18	18	Attrezzo allineamento albero a camme	22,50
FG 192/FO24-19	19	Attrezzo registrazione sensore di posizione albero motore	19,30
FG 192/FO24-20	20	Attrezzo di bloccaggio volano	12,50
FG 192/FO24-21	21	Attrezzo allineamento albero motore/pompa carburante	12,00
FG 192/FO24-22	22	Attrezzo di bloccaggio del volano	15,00
FG 192/FO24-23	23	Attrezzo di bloccaggio degli alberi a camme	15,00

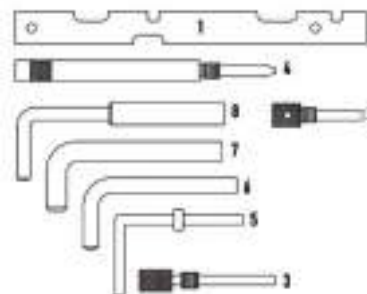

CODICE	n°	Descrizione	€/PZ
FG 192/FO24-4	1	Barra di bloccaggio albero a camme	12,00
FG 192/FO24-5	2	Perno di fasatura albero motore (40x5mm)	13,00
FG 192/FO24-7	3	Perno di fasatura albero motore (65x7,5mm)	8,30
FG 192/FO24-6	4	Perno di fasatura albero motore	17,50
FG 192/FO24-9	5	Perno di fasatura albero a camme (Ø 6mm)	12,50
FG 192/FO24-10	6	Perno di fasatura albero a camme (Ø 9,5mm)	6,20
FG 192/FO24-11	1	Perno di fasatura albero a camme (Ø 12,7mm)	6,20
FG 192/FO24-20	2	Attrezzo bloccaggio volano	12,50

SET FASATURA MOTORI FORD 2.0, 2.2, 2.4, DURATORQ 16V

Modelli:

Mondeo, Transit, Focus

Cilindrata: 2.0, 2.2 & 2.4 DURATORQ 16V

Codice motore: FMBA/B, HJBA, HJBB, HJBC, HJBE, SDBA, D5BA, D6BA, QJBA, QJBB, QJBC, ABFA, D3FA, F3FA, FIFA, D2FA, D4FA, DOFA, F4FA, FXFA, H9FA



CODICE	€/PZ
FG 192/F011	255,00

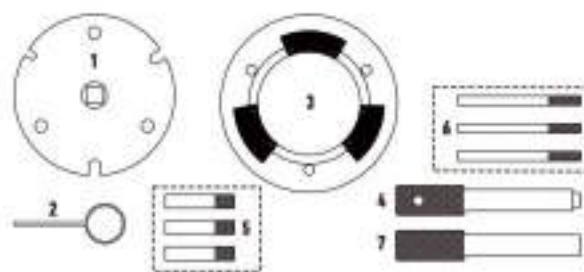

CODICE	n°	Descrizione	€/PZ
FG 192/F011-1	1	Piastra smontaggio/montaggio coperchio pompa carburante	77,10
FG 192/F011-2	2	Perno bloccaggio tendicatena ø 1.9	3,00
FG 192/F011-3	3	Piastra bloccaggio pignone pompa iniezione carburante	83,10
FG 192/F011-4	4	Perno bloccaggio volano ø 14 ø 10	23,70
FG 192/F011-5	5	Perni bloccaggio pompa gasolio	17,80
FG 192/F011-6	6	Perni bloccaggio pignoni alberi a camme ø 6	17,80
FG 192/F011-7	7	Perno bloccaggio volano ø 14	23,70



FASANO[®]
TOOLS

ATTREZZO DI INSERIMENTO DELLA RUOTA FONICA DELL'ALBERO MOTORI DIESEL LAND ROVER/JAGUAR

Applicazioni: Land Rover (Discovery 3 & 4; Range Rover Sport); Jaguar (X200 S TYPE; X250 XF; X350 XJ; X351 XJ)



CODICE	€/PZ
FG 192/LRF	220,00

SET FASATURA MOTORI JAGUAR E LAND ROVER 2.0 INGENIUM DIESEL

Modelli:

JAGUAR: E-Pace (X-540) D150/D180/D240; F-Pace (X761) 20d/25d/E-Performance, XE(X760) 20d/25d/E-Performance, XF(X260)

LAND ROVER: Discovery Sd4/Td4, Discovery Sport Td4/Sd4, Range Rover Evoque eD4/TD4/Sd4, Range Rover Evoque Convertible eD4/Td4/Sd4

Cilindrata: 2.0 D

Codice motore: 204DT, 204DTA, AJ-200D/204DT, AJ-200D, 204DTD



CODICE	€/PZ
FG 192/LR11	820,00

SET FASATURA MOTORI LAND ROVER DIESEL TD V8

Modelli: RANGE ROVER; RANGE ROVER SPORT

Cilindrata: 3.6 TD V8

Codice motore: 368DT



CODICE	€/PZ
FG 192/LR13	465,00



SET FASATURA MOTORI JAGUAR E LAND ROVER 3.2, 3.5, 4.0, 4.2, 4.4 V8

Modelli:

JAGUAR: XJ8, XJ8 Sport, Sovereign, XJR V8, XKR, S-Type, XK8
LAND ROVER: Range Rover Supercharged, Discovery 3, Range Rover
DAIMLER: V8, Super V8

Cilindrata: 3.2, 3.5, 4.0, 4.2

Codice motore: AC, KB, KC, RB, BC, CC, CE, LB, LC, MA, MB, NB, NC, 1B, 2B, 3B, 1G, 5G, 9G, HB, HG, SB, TB, PC, 428PS, 448PN, BC, DC



CODICE

FG 192/LR9

€/PZ

370,00

SET FASATURA MOTORI JAGUAR E LAND ROVER 2.0 GTDI

Modelli:

JAGUAR: XE, XJ, XF
LAND ROVER: Discovery Sport, Freelander 2
RANGE ROVER: Evoque

Cilindrata: 2.0 GTDI

Codice motore: 204PT



CODICE

FG 192/LR8

€/PZ

315,00

SET RIMOZIONE/INSTALLAZIONE PULEGGIA ALBERO MOTORE JAGUAR & LAND ROVER V8

Modelli:

JAGUAR: XJ8; XJ8 Sport; Sovereign; XJR V8; XKR; S-Type; XK8
LAND ROVER: Range Rover Supercharged; Discovery 3; Range Rover

Cilindrata: 3.2; 3.5; 4.0; 4.2

Codice motore: AC, KB, KC, RB, BC, CC, CE, LB, LC, MA, MB, NB, NC, 1B, 2B, 3B, 1G, 5G, 9G, HB, HG, SB, TB, PC, 428PS, 448PN, BC, DC



CODICE

FG 192/LR6

€/PZ

275,00

SET FASATURA MOTORI LAND ROVER TD5

Modelli: LAND ROVER: Defender, Discovery II

Cilindrata: 2.5 Diesel

Codice motore: 10P, 15P, 16P



CODICE

FG 192/LR2

€/PZ

55,00

SET FASATURA MOTORI BMW MINI ONE, COOPER, COOPER S 1.6 BENZINA (R50/R52/R53)

Modelli:

Mini Cooper 2001-09; Mini Cooper S 2002-2004;
Mini One 2001-2009

Cilindrata: 1.6 benzina

Codice motore: W10B16BA; W11B16AA; W10B16AA



CODICE

FG 192/MI6

€/PZ

210,00

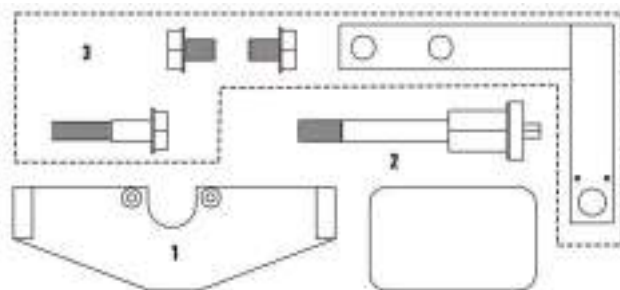

CODICE

FG 192/MI6-1

n°

1

Descrizione

Attrezzo di bloccaggio pignone albero a camme

€/PZ

70,20

FG 192/MI6-2

2

Staffa di supporto motore

39,00

FG 192/MI6-3

3

Attrezzo di montaggio tendicatena

101,40

SET FASATURA MOTORI MINI, PSA 1.4, 1.6 VTI

Modelli:

Mini: Clubman

Citroen: C3 III; C4 II; DS3/DS3 Cabrio; Berlingo III; C3 Picasso; C4 Picasso/Grand Picasso II; C5 III (2010 - 2013); DS4

Peugeot: 308; 207; 208; 3008; 308; 308 CC; 5008; 508; Partner III

Cilindrata: 1.4 VTI, 1.6 VTI

Codice motore: 8FR(EP3C); 5FS (EP6C); 5FW (EP6); EP3C (8FR); EP6C (5FS); EP3 (8FS)



CODICE	€/PZ
FG 192/MI10B	320,00

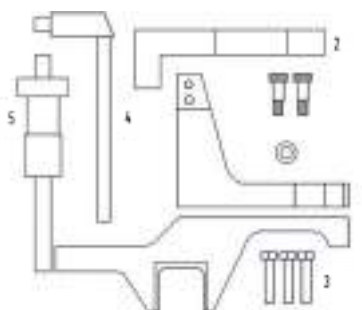

CODICE	n°	Descrizione	€/PZ
FG 192/MI10B-1	1	Attrezzo bloccaggio albero a camme di aspirazione	185,00
FG 192/MI10B-2	2	Attrezzo di bloccaggio albero a camme di scarico	110,00
FG 192/MI10B-3	3	Viti	8,50
FG 192/MI10B-4	4	Attrezzo bloccaggio volano	30,00
FG 192/MI10-4	5	Attrezzo di pretensionamento catena della distribuzione	32,50

SET FASATURA MOTORI MINI, PSA 1.4, 1.6 16V N12&N14

Modelli:

Mini: Mini One, Mini Couper, Mini Couper S, Mini Clubman

Citroen: C4, C4 Picasso

Peugeot: 207, 308

Cilindrata: 1.4 (N12/N14), 1.6 THP

Codice motore: R55, R56, EP3, EP6, EP6DT, DTS



CODICE	€/PZ
FG 192/MI10	365,00

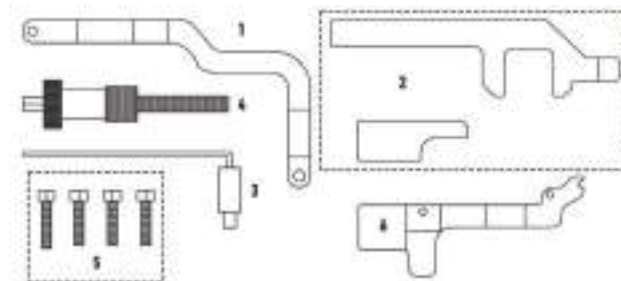

CODICE	n°	Descrizione	€/PZ
FG 192/MI10-1	1	Attrezzo allineamento albero a camme aspirazione (N12)	98,00
FG 192/MI10-2	2	Attrezzo allineamento albero a camme aspirazione + Staffa fissaggio albero a camme di scarico (N14)	110,00
FG 192/MI10-3	3	Perno di fasatura albero motore	12,00
FG 192/MI10-4	4	Attrezzo di pretensionamento catena della distribuzione	32,50
FG 192/MI10-5	5	Viti di fissaggio	3,10
FG 192/MI10-6	6	Attrezzo allineamento albero a camme di scarico (N12 & N14)	95,00

SET FASATURA MOTORI BMW MINI 1.6 W16D

Modelli:

MINI: Clubman (Cooper D) (R55), Cooper D (R56/57), One D (R56/57)

CITROEN: Berlingo III, Berlingo/Berlingo First I/II, C2, C3 I/II/ First/Classic, C3 Picasso, C4, C4 Picasso/Grand Picasso, C5 II, C5 III, Xsara Picasso, C4 Aircross, C4 II, DS3/DS3 Cabrio, DS4, DS5, Dispatch/Jumpy III

PEUGEOT: 1007, 206, 206 CC, 207, 207 CC, 3008, 307, 308, 308 CC, 407, 5008, Partner III, Partner/Partner Origin/Ranch I/II, Expert III

Cilindrata: 1.6 D, 1.6 Hdi, 1.6 e-HDi Airdream, 1.6 e-Hdi

Codice motore: W16 D16 (9HZ), W16 D16U0



CODICE	€/PZ
FG 192/MI9	82,00

SET FASATURA MOTORI MERCEDES BENZ 1.8,2.1 CDI DIESEL -M651 DAL 2012

Modelli:

Classe A, Classe B, Classe C, Classe E, CLS, Sprinter, Viano, Vito

Cilindrata: 1.8 CDI, 2.1 CDI

Codice motore: M651 dal 2012 in poi



CODICE	€/PZ
FG 192/MB3C	260,00



SET FASATURA MOTORI MERCEDES BENZ 1.8/2.1 CDI DIESEL - M651

Modelli:

Classe-A, Classe-B, Classe-C, Classe-C Coupe, CLA, CLS, Classe E, Classe E, Coupe/Cabriolet, GLK, Classe-M, Classe-S, SLK, Sprinter, Viano, Vito

Cilindrata: 1.8 CDI, 2.1 CDI

Codice motore: 651.901, 651.910, 651.911, 651.912, 651.913, 651.916, 651.922, 651.924, 651.925, 651.930, 651.940, 651.955, 651.956, 651.957



CODICE

FG 192/MB3

€/PZ

248,00

ATTREZZO DI BLOCCAGGIO DELL'ALBERO EQUILIBRATORE MOTORI MERCEDES-BENZ 1.8/2.1 CDI DIESEL (M651)

Modelli:

Classe-A, Classe-B, Classe-C, Classe-C Coupe, CLA, CLS, Classe E, Classe E, Coupe/Cabriolet, GLK, Classe-M, Classe-S, SLK, Sprinter, Viano, Vito

Cilindrata: 1.8 CDI, 2.1 CDI

Codice motore: 651.901, 651.910, 651.911, 651.912, 651.913, 651.916, 651.922, 651.924, 651.925, 651.930, 651.940, 651.955, 651.956, 651.957, 651.960, 651.961, 651.980



CODICE

FG 192/MB3A

€/PZ

210,00

SET FASATURA MOTORI MERCEDES BENZ 1.3 BENZINA - M282

Modelli: Classe A; Classe B; CLA

Cilindrata: 1.3

NEW



CODICE

FG 192/MB4

€/PZ

300,00

SET FASATURA MOTORI MERCEDES BENZ 1.6D, 2.0D - M654

Modelli: Classe A; Classe B; Classe C; Classe E; Classe G; Classe S; Classe V; CLA; CLS; GLA; GLB; GLC; Vito

Cilindrata: 1.6D, 2.0D

Codice motore: 654.916; 654.920

NEW



CODICE

FG 192/MB7

€/PZ

280,00

SET BLOCCAGGIO/ALLINEAMENTO ALBERI A CAMME PER MOTORI MERCEDES BENZ 1.6/2.0

Modelli:

Classe A, Classe B, CLA, Classe C, Classe C Coupe, Classe E, GLK

Cilindrata: 1.6, 2.0 Benzina

Codice motore: 270.910, 270.920, 133.980, 274.910, 274.920

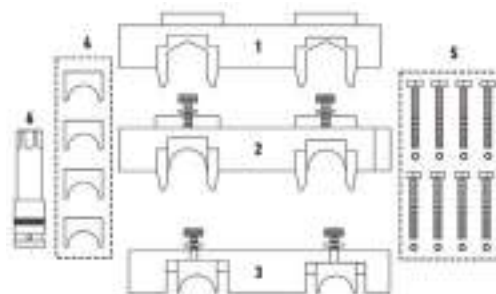
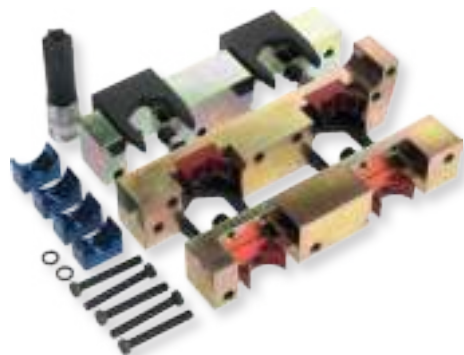

CODICE

FG 192/MB24

€/PZ

820,00

CODICE

CODICE	n°	Descrizione	€/PZ
FG 192/MB24-1	1	Gruppo bloccaggio albero a camme (dal 2009 al 2014)	230,00
FG 192/MB24-2	2	Gruppo bloccaggio albero a camme (dal 2014 -)	150,00
FG 192/MB24-3	3	Gruppo bloccaggio albero a camme (estremità scatola del cambio)	250,00
FG 192/MB24-4	4	Blocchi per albero a camme di diametro ridotto	60,00
FG 192/MB24-5	5	Viti per gruppo di bloccaggio albero a camme	8,00
FG 192/MB24-6	6	Chiave a bussola di sicurezza	20,00

SET FASATURA MOTORI MERCEDES-BENZ 1.8

Modelli:

Classe C; Classe C Coupe; Classe CLC; CLK;

Classe E; SLK; Sprinter

Cilindrata: 1.8 Benzina

Codice motore: 271.820; 271.860; 271.861; 271.921; 271.940; 271.941; 271.942; 271.944; 271.946; 271.948; 271.950; 271.951; 271.952; 271.954; 271.955; 271.956; 271.957; 271.958



CODICE	€/PZ
FG 192/MB5	360,00

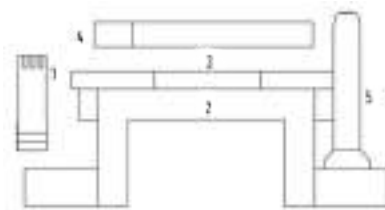

CODICE	n°	Descrizione	€/PZ
FG 192/MB5-1	1	Chiave a bussola	19,00
FG 192/MB5-2	2	Attrezzo bloccaggio catena della distribuzione sul pignone dell'albero a camme	129,00
FG 192/MB5-3	3	Attrezzo bloccaggio albero a camme	118,00
FG 192/MB5-4	4	Cuneo di guida del tendicatena dell'albero a camme	38,00
FG 192/MB5-5	5	Punzone per tendicatena	29,00

SET FASATURA MOTORI MERCEDES-BENZ M642

Modelli:

Classe C; CLK; CLS; CLASSE E; CLASSE GL; GLK;

CLASSE M; CLASSE R; CLASSE S; SPINTER; VITO; VIANO

Cilindrata: 3.0 Diesel

Codice motore: M642 (642,82; 642,822; 642,83; 642,835; 642,836; 642,838; 642,992)



CODICE	€/PZ
FG 192/MB10	160,00

SET FASATURA MOTORI CHRYSLER, JEEP, DODGE

Modelli:

CHRYSLER: Grand Voyager

JEEP: Cherokee, Wrangler

DODGE: Nitro

Cilindrata: 2.8 Diesel

Codice motore: VM64C, ENS, ENS (51C), 49C, 50C, ENS VM10D



CODICE	€/PZ
FG 192/CH3	145,00

SET FASATURA MOTORI 2.1, 2.2, 2.7, 3.2 CDI/CRD MERCEDES-BENZ E CHRYSLER

Modelli:

Mercedes-Benz: Classe-C; Classe-CLC; CLK; Classe-E; Viano; Vito; Sprinter; Classe-M; Classe-S

Chrysler: PT Cruiser

Cilindrata: 2.1 CDI; 2.2 CDI; 2.7 CDI; 3.2 CDI; 2.2 CRD

Codice motore: 611.960; 611.961; 611.962; 611.987; 611.980; 611.981; 612.961; 612.962; 612.963; 612.965; 612.967; 613.960; 613.961; 646.811; 646.812; 646.820



CODICE	€/PZ
FG 192/MB6	180,00

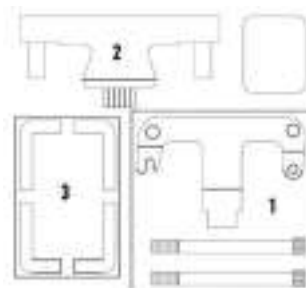

CODICE	n°	Descrizione	€/PZ
FG 192/MB6-1	1	Attrezzo di bloccaggio volano/piastra di comando con bulloni M 6x90 mm	56,00
FG 192/MB6-2	2	Attrezzo di bloccaggio volano/piastra di comando (apertura motorino di avviamento)	73,00
FG 192/MB6-3	3	Perni di bloccaggio albero a camme (2 pezzi)	35,00



SET FASATURA MOTORI JEEP E CHRYSLER 2.5 CRD / 2.8 CRD

Modelli:

JEEP: Cherokee, LDV: Maxus

CHRYSLER: Grand Voyager, Voyager

Cilindrata: 2.5CRD, 2.8CRD

Codice motore: R2516C, R2816C5.05A, R2516K, R2816K4, R2516L VM39/40B, R2516L7 VM57/58C



CODICE

FG 192/CH8

€/PZ

220,00



CODICE	n°	Descrizione	€/PZ
FG 192/CH8-1	1	Perno bloccaggio albero a camme aspirazione	34,40
FG 192/CH8-2	2	Perno bloccaggio albero a camme di scarico	24,60
FG 192/CH8-3	3	Perno bloccaggio volano (Voyager/Grand Voyager 2.5/2.8 and LVD Maxus)	29,50
FG 192/CH8-4	4	Perno bloccaggio volano (Jeep Cherokee 2.8)	27,00
FG 192/CH8-5	5	Perno bloccaggio volano (Jeep Cherokee 2.5)	27,00
FG 192/VW1D	6	Attrezzo per la puleggia del tendicinghia	32,00
FG 192/CH8-7	7	Perno bloccaggio albero equilibratore	14,70
FG 192/CH8-8	8	Perno bloccaggio volano (albero equilibratore)	29,50

SET FASATURA MOTORI JEEP GRAND CHEROKEE 3.0 CRD(MULTIJET (DAL 2011))

Modelli:

JEEP: Grand Cherokee

Cilindrata: 3.0 CRD/Multijet

Codice motore:

EXF VM23D; EXF VM44D; EXF



CODICE

FG 192/JE9

€/PZ

295,00

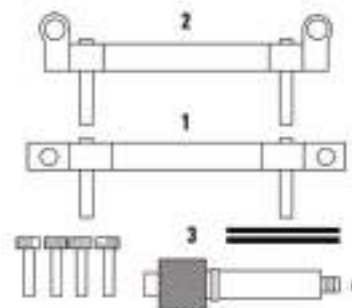

CODICE	n°	Descrizione	€/PZ
FG 192/JE9-1	1	Attrezzo di allineamento alberi a camme (DX)	120,00
FG 192/JE9-2	2	Attrezzo di allineamento alberi a camme (SX)	140,00
FG 192/JE9-3	3	Coppia di perni bloccaggio tendicinghia	6,00
FG 192/JE9-4	4	Perno di fasatura albero motore	65,00

SET FASATURA MOTORI OPEL 1.0, 1.2, 1.4 A CATENA

Modelli: Corsa; Combo; Agila; Astra; Meriva; Tigra

Cilindrata: 1.0 12V; 1.0 16V; 1.2 16V; 1.4 16V

Codice motore: X10XE, Z10XE, Z10XEP, Z12XE, Z12XEP, Z14XEP, Z14XEL



CODICE

FG 192/OP5

€/PZ

120,00

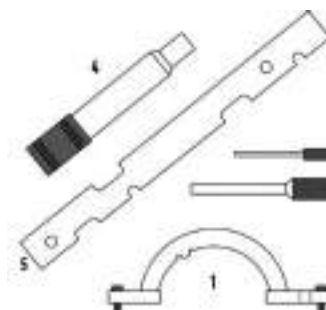

CODICE	n°	Descrizione	€/PZ
FG 192/OP5-1	1	Attrezzo di registrazione disco sensore di posizione albero a camme	67,00
FG 192/OP5-2	2	Perno di bloccaggio tendicatena 4mm	6,50
FG 192/OP5-3	3	Perno di bloccaggio tendicatena 2,5 mm	6,50
FG 192/OP5-4	4	Perno di bloccaggio albero motore	21,00
FG 192/OP5-5	5	Attrezzo di bloccaggio albero a camme	15,00

KIT AGGIORNAMENTO PER FG 192/OP5

Permette la fasatura anche dei seguenti modelli:

Adam, Ampera, Astra-J, Insignia, Meriva-B, Mokka, Zara-C Tourer, Astra-G, Astra-H, Barina, Meriva-A, Tigra-B

Cilindrate aggiuntive : 1.0 ecoFLEX, 1.2 ecoFLEX, 1.4 ecoFLEX, 1.4 Turbo ecoFLEX
Codici motore aggiuntivi : LWD, L2Z, LDD, LUU/A14XFL, LDD/A14XEL, LDD/A14XER, LUJ/A14NEL, LUJ/A14NET, A10XEP, A12XEL, AA12XER, A14XER, A14NEL, LUJ/A14NET, LUH/A14NEL, A14NET



CODICE	€/PZ
FG 192/OP7B	230,00

SET FASATURA MOTORI OPEL 1.0, 1.2, 1.4 A CATENA ED ECOFLEX

Modelli:

Adam, Agila, Ampera, Astra-J, Corsa-D, Insignia, Meriva-B, Mokka, Zara-C Tourer, Corsa-B, Corsa-C, Astra-G, Astra-H, Combo, Combo-C, Barina, Meriva-A, Tigra-B
Cilindrata: 1.0, 1.0 ecoFLEX, 1.2, 1.2 ecoFLEX, 1.4, 1.4 ecoFLEX, 1.4 Turbo ecoFLEX
Codice motore: LWD, L2Z, LDD, LUU/A14XFL, LDD/A14XEL, LDD/A14XER, LUJ/A14NEL, LUJ/A14NET, A10XEP, A12XEL, A12XER, A14XER, A14NEL, LUJ/A14NET, LUH/A14NEL, A14NET



CODICE	€/PZ
FG 192/OP7	325,00

SET FASATURA MOTORI OPEL 1.4-2.2 16V ECOTEC

Modelli:

Astra F, G e H; Corsa B e C; Combo; Tigra; Vectra B e C; Zafira A e B; Meriva; Signum; Calibra; Omega B; Frontera A e B

Cilindrata: 1.4 16V; 1.6 16V; 1.8 16V; 2.0 16V; 2.2 16V

Codice motore:

1.4 16V: X14XE, Z14XE, X16SEJ, X16XE, X16XEL, Y16XE, Z16XE, Z16YNG
1.8 16V: C18XEL, X18E1, X18XE, X18XE1, Z18XE, Z18XEL
2.0 16V: C20SEL, X20XEV, Z20LEH; Z20LEL; Z20LER; Z20LET
2.2 16V: X22SE, X22XE, Y22SE, Y22XE, Z22X



CODICE	€/PZ
FG 192/OP2	55,00



KIT BLOCCAGGIO PULLEGGE OPEL 1.6 16V

Modelli:

Astra G e H; Astra H Turbo; Corsa D

Cilindrata: 1.6 16V

Codice motore: Z16XE1, Z16XER, Z16XEP, Z16LET, Z16LER

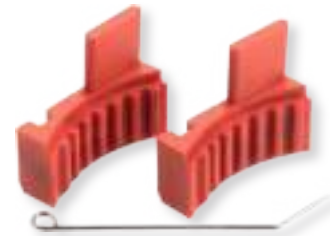

CODICE	€/PZ
FG 192/OP3	55,00



ATTREZZO DI BLOCCAGGIO DELLA PULEGGIA ALBERO MOTORE PER MOTORI OPEL 1.0/1.4 B10/B14

Modelli: Astra-K; Karl; Karl Rocks; Mokka X; Viva

Cilindrata: 1.4; 1.4 Turbo; 1.0; 1.0 ecoFLEX; 1.0 LPG ecoFLEX; 1.0 LPG ecoFLEX

Codici motore: LV7/B14XE; LE2/B14XFL; LE2/B14XFT; L5Q/B10XE; LWT/B10XL



CODICE	€/PZ
FG 192/OP3B	245,00



SET FASATURA MOTORI OPEL 1.0, 1.4 B10/B14

Modelli: Adam; Adam Rocks; Astra-K; Corsa-E; Mokka X

Cilindrata:

1.0; 1.0 Turbo SIDI; 1.0 Turbo SIDI ecoFLEX; 1.4; 1.4 Turbo

Codice motore: LE1/B10XFL; LE1/B10XFT; LE1/B10XHL; LV7/B14XE; LE2/B14XFL; LE2/B14XFT



CODICE

FG 192/OP3A

€/PZ

110,00

SET FASATURA MOTORI OPEL 1.3 CDTI

Modelli:

Astra, Corsa, Agila, Combo, Meriva

Cilindrata: 1.3 CDTI

Codice motore: Z13DT, Z13 DTH, Z13 DTJ



CODICE

FG 192/OP4

€/PZ

105,00

PERNO BLOCCAGGIO VOLANO OPEL 1.3 CDTI



CODICE

FG 192/OP1

€/PZ

16,00

SET FASATURA MOTORI OPEL 1.3 CDTI

Modelli: Corsa-E

Cilindrata: 1.3 CDTI

Codice motore: LKU/B13DTE; LKV/B13DTC; LKU/B13DTR



CODICE

FG 192/OP4D

€/PZ

565,00

SET FASATURA MOTORI OPEL 1.6 CDTI E 1.6 SIDI TURBO (DAL 2013 IN POI)

Modelli: Astra-J; Astra-K; Insigna; GTC; Meriva-B; Mokka;

Zafira-C Tourer; Cascada

Cilindrata: 1,6 CDTI; 1.6CDTI ecoFLEX; 1.6SIDI Turbo;

1.6SIDI Turbo ecoFLEX

Codice motore: LVL/B16DTH; LVL/B16DTJ; LVL/B16DTN; LVM/B16DTL; LVM/B16DTC;

LWQ/B16DTC; LWQ/B16DTE; LVK/ B16DTR; LWV/B16DTU;

LWC/A16SHT; LWC/B16SHL; LWC/B16SHT; LVP/A16XHT



CODICE

FG 192/OP4B

€/PZ

360,00

SET FASATURA MOTORI OPEL 2.0 CDTI, CHEVROLET 2.0D VCDI

Modelli: Antara, Captiva, Epica, Nubira, Lacetti, Evada

Cilindrata: 2.0 CDTI

Codice motore: Z20DMH, Z20DM, Z20S1, RA420



CODICE

FG 192/OP6

€/PZ

110,00

SET FASATURA MOTORI OPEL 2.0, 2.2

Modelli:

OPEL: Omega-B, Vectra-B, Astra-G, Zara-A, Signum, Frontera-B
SAAB: 9-3, 9-5

Cilindrata: 2.0 DTi, 2.2 DTi, 2.2 TiD

Codice motore: X20DTH, X20DTL, Y20DTH, X22DTH, Y22DTR, D223L



CODICE	€/PZ
FG 192/OP8	180,00

SET FASATURA MOTORI OPEL 2.0 CDTI

Modelli:

OPEL: Cascada; Insignia-A Country Tourer; Insignia-A; Zafira-C Tourer

Cilindrata: 2.0 CDTi, 2.0 CDTiEcoflex

Codice motore: LFS/B20DTH



CODICE	€/PZ
FG 192/OP15	520,00

SET FASATURA MOTORI OPEL, SAAB 2.0 TURBO

MODELLI:

OPEL: Signum, Vectra-C

SAAB: 9-3

Cilindrata: 2.0, 2.0 TURBO

Codice motore: Z20NET; B207E; B207L



CODICE	€/PZ
FG 192/OP10	210,00

SET FASATURA MOTORI OPEL, SAAB, CHEVROLET 2.0 E 2.4 TURBO

Modelli:

Opel: Astra; Astra-J; Insignia; Antara

Saab: 9-5

Chevrolet: Captiva; HHR; Malibu

Cilindrata: 2.0 e 2.4 D (OPC; OPC/VXR); Turbo; Turbo ecoFLEX

Codice motore: LHU/A20NFT; LKD/A20NHT; A24XE; A24XF; LE5; LE9



CODICE	€/PZ
FG 192/OP9	360,00



SET FASATURA MOTORI PSA 1.4 E 1.6HDI

Modelli:

Peugeot: 107, 206, 206 Cc 207, 307, 307 Cc, 308, 406, 406 Coupe, 407, 607, 806, Expert I/II, Expert III, 807

Citroen: Xsara Picasso, Xsara II, C1, C3, C3 Pluriel, C4, C4 Picasso, Grand Picasso, Berlingo/Berlingo First I/II, C5 I, C5 II, C8, Dispatch/Jumpy III, Synergie/Evasion

Cilindrata: 1.4D Hdi, 1.6D Hdi, 1.8, 1.8 16V, 2.0, 2.0 16V, 2.0 Hpi, 2.0 Gti 180/RC, 2.2

Codice motore: EW10A(RFJ), EW10D(RLZ), EW10J4(RFR), W10J4L5(RFN), EW10J4S(RFK), EW12J4(3FY/3FZ), EW12J4/5(3FZ), EW7A(6FY), EW7J4(6FZ), 9H Y/9HZ(DV6TED4), 9HX(DV6ATED4), 9HW(DV6BTED4), 9HU(DV6UTED4), DV4TD (8HT/8HX/8HW/8H- V/8HY/8HZ)



CODICE	€/PZ
FG 192/PS13	205,00

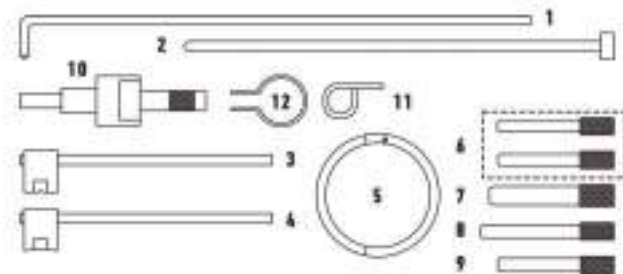

CODICE	n°	Descrizione	€/PZ
FG 192/PS13-1	1	Perno di tensionamento	20,00
FG 192/PS13-2	2	Attrezzo di bloccaggio della puleggia del tendicinghia	20,00
FG 192/PS15-6	3	Attrezzo di tensionamento	14,29
FG 192/PS15-5	4	Attrezzo di tensionamento	14,29
FG 192/PS13-5	5	Attrezzo di registrazione della puleggia del tendicinghia	51,50
FG 192/PS13-6	6	Perni di fasatura	25,80
FG 192/F024-22	7	Perno di fasatura	15,00
FG 192/PS15-7	8	Perno di fasatura	15,00
FG 192/F024-23	9	Perno di tensionamento	15,00
FG 192/PS13-10	10	Attrezzo di bloccaggio della puleggia del tendicinghia	32,20
FG 192/PS13-11	11	Attrezzo di tensionamento	4,80
FG 192/PS13-12	12	Attrezzo di tensionamento	3,20

SET MESSA IN FASE MOTORI PSA 1.9D, 2.0D HDI, 2.2D HDI

Modelli:

Xsara; 307; 406; 607; 806; Expert I/II; 807; 206; 306;

Boxer; 406 Coupe

Cilindrata: 1.9D, 2.0D HDi, 2.2D HDi

Codice motore: DW8/L3(WJZ), DW10TD(RHY), W10ATED(RHS), W10ATED(RHZ), DW10ATED4/L4(RHT), DW10BTED(RHX), W10JATED4(RHW), DW10TD(RHY), DW10UT-D(RHV), W12ATED(4HX), DW12ATED(4HZ), DW12UTED(4HY), DW8(WJY), DW8/L/W3(WJZ), DW8B/L4(WJY)

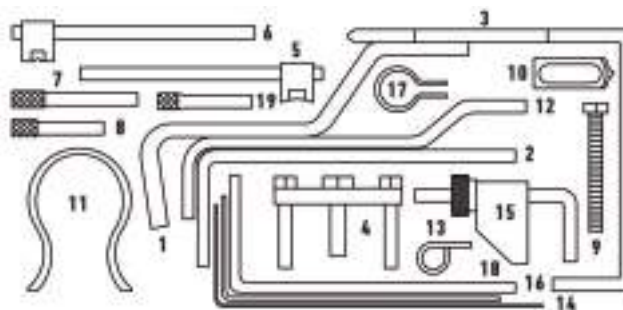

CODICE	n°	Descrizione	€/PZ
FG 192/PS15-1	1	Perno di fasatura volante	9,10
FG 192/PS15-2	2	Perno bloccaggio volante	10,37
FG 192/PS15-3	3	Perno di fasatura del volante - 8 mm	10,37
FG 192/PS15-4	4	Estrattore della puleggia albero motore	26,03
FG 192/PS15-5	5	Attrezzo di tensionamento	14,29
FG 192/PS15-6	6	Attrezzo di tensionamento	14,29
FG 192/PS15-7	7	Perno di fasatura 8mm	15,00
FG 192/PS15-8	8	Perno di fasatura 6mm	15,00
FG 192/PS15-9	9	Bullone M8x80mm	1,27
FG 192/PS15-10	10	Attrezzo di bloccaggio del volante	9,10
FG 192/PS15-11	11	Fermaglio cinghia di distribuzione	5,19
FG 192/PS15-12	12	Perno di fasatura del volante	9,10
FG 192/PS13-11	13	Attrezzo di centraggio del pignone albero motore	4,80
FG 192/PS15-14	14	Pernodil bloccaggio del tendicinghia	7,83
FG 192/PS15-15	15	Morsetto cinghia di distribuzione	98,83
FG 192/PS15-16	16	Attrezzo bloccaggio puleggia tendicinghia organi ausiliari	6,46
FG 192/PS15-17	17	Attrezzo di centraggio del pignone albero motore	5,19
FG 192/PS15-18	18	Perno di fasatura volante	7,80
FG 192/PS15-19	19	Perno bloccaggio albero a camme	15,00

CODICE	€/PZ
FG 192/PS15	280,00

SET MESSA IN FASE MOTORI PSA, LAND ROVER, JAGUAR

Modelli:

PEUGEOT: 407, 607

CITROEN: C5 III, C6

LAND ROVER: Discovery 3, Discovery 4, Range Rover Sport.

JAGUAR: S-Type, XF, XJ6.

Cilindrata: 2.7, 2.7 TDV6, 2.7 TDVi, 2.7 HDI

Codice motore: 276DT, 276DT (7B/7G), 7G, UHZ (DT17BTED4), DT17TED4 (UHZ)



CODICE	€/PZ
FG 192/PS7	225,00

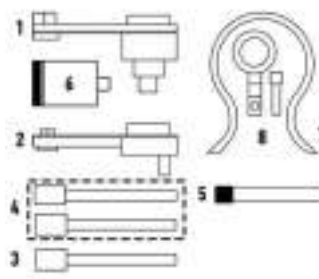

CODICE	n°	Descrizione	€/PZ
FG 192/PS7-1	1	Attrezzo Fasatura Volano (Cambio Automatico)	45,00
FG 192/PS7-2	2	Attrezzo Fasatura Volano (Cambio Manuale)	53,00
FG 192/PS7-3	3	Attrezzo allineamento pignone albero a camme	5,10
FG 192/PS7-4	4	Perni fasatura pignone albero a camme (2pz)	12,70
FG 192/PS7-5	5	Attrezzo di bloccaggio della puleggia pompa dell'acqua	6,40
FG 192/PS7-6	6	Attrezzo di bloccaggio del volano	12,70
FG 192/PS15-11	7	Fermaglio per la cinghia di distribuzione	5,19
FG 192/PS7-8	8	Supporto pompa carburante	50,00



SET FASATURA MOTORI PSA BENZINA 1.2 CON CINGHIA BAGNO D'OLIO



Modelli: C1 (2015-2018); C3 Aircross (dal 2016); Berlingo (dal 2018); C4 Cactus (dal 2014); C5 Aircross (dal 2019); DS4 (2014-2019); DS3 (dal 2016); DS7 (dal 2018); 208 (dal 2014); 308 (dal 2014); 508 (dal 2019); 2008 (dal 2013); 3008 (dal 2014); 5008 (dal 2014)

Cilindrata: 1.2

Codice motore: EB2



CODICE	€/PZ
FG 192/PS5	280,00

SET FASATURA MOTORI PSA / FIAT 2.5D, 2.8 -CINGHIA

Modelli:

PEUGEOT: Relay/Jumper

CITROEN: Boxer, Boxer II

FIAT: Ducato, Croma, Talento

Cilindrata: 2.8, 2.8 TDi, 2.8 HDI

Codice motore: 8140.63, 8140.43S, 8140.43N, 8144.67, 8140.27, 8140.47R, 8144.21, 8140.47



CODICE	€/PZ
FG 192/PS4	55,00

SET FASATURA MOTORI PSA 1.0VTI, 1.2VTI

Modelli:

PEUGEOT: 208, 308, 2008

CITROEN: C3 III, DS3/DS3 Cabrio

Cilindrata: 1.0 VTi, 1.2 VTi

Codice motore: EBO(ZMZ), EB2(HMZ), ZMZ(EBO)



CODICE	€/PZ
FG 192/PS2	225,00



UTENSILE PER INSTALLAZIONE CINGHIA ELASTICA DELLA POMPA DELL'ACQUA PER MOTORI PSA E OPEL 1.0/1.2 3 CILINDRI (DAL 2012 IN POI)



Modelli:

Peugeot: 108, 208, 301, 308, 408, 2008, 3008, 5008, Partner

Opel: Crossland X

Citroen: C1, C3, C3 Picasso, C3 Aircross, C4, C4 Picasso, C4 Cactus, Berlingo, DS3, DS4, DS4S, DS5LS

Cilindrata:

1.0, 1.2 benzina 3 cilindri



CODICE	€/PZ
FG 192/PSA	35,00

SET FASATURA MOTORI PSA 1.4 16V



Modelli:

CITROEN: Berlingo/Berlingo First I/II; C2

PEUGEOT: 1007; 206; 207; 307

Cilindrata: 1.4 benzina a cinghia

Codice motore: KFW(TU3A); KFW(TU3JP/L4); Kfv(TU3A); Kfv(TU3JP); ET3J4(KFU); ET3JP4(KFU);TU3A(KFV)



CODICE	€/PZ
FG 192/PS7B	65,00

SET MESSA IN FASE MOTORI RENAULT & NISSAN 1.4, 1.6 16V BENZINA, 1.8 16V, 2.0 16V



Modelli:

Clio, Megane, Megan Scenic, Laguna, Espace, Grand Espace, Kubistar, Primastar

Cilindrata: 1.4, 1.6 16V, 1.8 16V, 2.0 16V

Codice motore: K4J, K4M, F4P, F4R



CODICE	€/PZ
FG 192/RE5	195,00

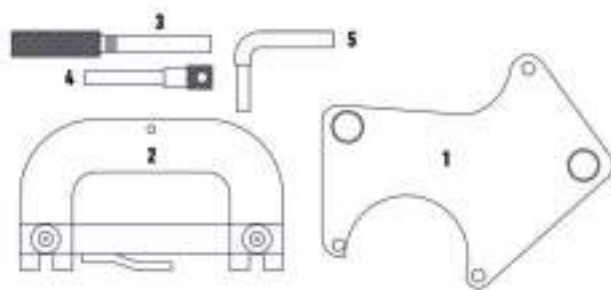

CODICE	n°	Descrizione	€/PZ
FG 192/RE3-1	1	Attrezzo di bloccaggio dei pignoni alberi a camme	71,00
FG 192/RE5-2	2	Barra di bloccaggio albero a camme	56,90
FG 192/RE3-3	3	Perno di fasatura albero motore (1.4/1.6)	15,00
FG 192/RE3-2	4	Perno di fasatura albero a camme (1.8/2.0)	9,70
FG 192/RE5-5	5	Perno di fasatura albero motore (1.8/2.0)	10,70

SET FASATURA MOTORI RENAULT 1.5DCI, 1.4 & 1.6 16V



Modelli: Clio, Kangoo, Megane, Scenic, Grand Scenic II, Clio III

Cilindrata: 1.5dCi, 1.4 & 1.6 16V

Codice motore: 1.5 dCi: K9K dal 2001;

1.4&1.6 16V: K4M,708, 716, 730, 732, 750, 752, 753, 760, 761, 766, 782, 800, 801, 812, 813



CODICE	€/PZ
FG 192/RE3	115,00

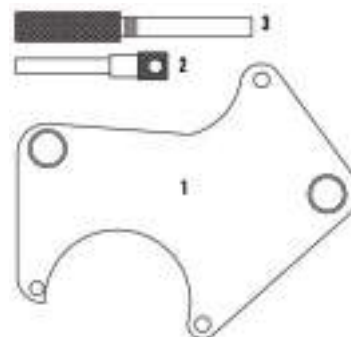

CODICE	n°	Descrizione	€/PZ
FG 192/RE3-1	1	Attrezzo bloccaggio pignoni alberi a camme	71,00
FG 192/RE3-2	2	Perno di fasatura albero a camme	9,70
FG 192/RE3-3	3	Perno di fasatura albero motore	15,00

SET FASATURA MOTORI RENAULT, NISSAN 1.6 DCI

Modelli:

Nissan: Qashqai; Qashqai+2; X-Trail

Renault: Espace; Fluence; Megane III; Scenic/Grand Scenic III; Trafic III

Cilindrata: 1.6dCi

Codice motore: 1.5 dCi: K9K dal 2001;

R9M; R9M 410; R9M 409; R9M 452; R9M 402; R9M 404; R9M 408; R9M 413; R9M 450; R9M 452



CODICE	€/PZ
FG 192/RE4	245,00

ATTREZZO BLOCCAGGIO PIGNONE ALBERO A CAMME MOTORI RENAULT 1.8 E 2.0 16V

Modelli: Clio III; Laguna III Turbo/GT Turbo; Megane II; Megane III; Laguna; Megane; Scenic

Cilindrata: 1.8 e 2.0 16V benzina

Codice motore: F4R 830; F4R 832; F4RT 800; F4RT 802; F4RT 820; F4RT 810; F4RT 811; F4RT 813; F4RT 774; F4RT 776; F4RT 872; F4RT 874; F4RT 870; F4RT 874; F4P 760; F4P 720; F4P 722



CODICE	€/PZ
FG 192/RE7	98,00

SET MESSA IN FASE MOTORI RENAULT, OPEL, NISSAN 1.5, 1.9, 2.2, 2.5 DCI

Modelli:

Clio, Kangoo, Megane, Scenic, Grand Scenic, Modus, Logan, Almera, Micra, Qashqai, Kubistar, Laguna, Trafic II, Movano, Vivaro, Primera, Interstar, Primastar, Espace, Grand Espace

Cilindrata: 1.5, 1.9, 2.2, 2.5 dCi

Codice motore: 1.5 dCi: K9K, 1.9 dCi: F9Q, 2.2 dCi: G9T, 2.5 dCi: G9U, 750, 752, 753, 760, 761, 766, 782, 800, 801, 812, 813



CODICE	€/PZ
FG 192/RE13	315,00

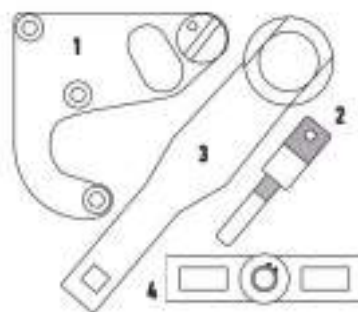

CODICE	n°	Descrizione	€/PZ
FG 192/RE4-1	1	Attezzo supporto/allineamento albero a camme	90,00
FG 192/RE4-2	2	Perno di fasatura albero motore	18,00
FG 192/RE6-5	3	Attezzo bloccaggio puleggia albero motore	47,30
FG 192/RE6-6	4	Attezzo allineamento ingranaggi a 2pezzi albero a camme aspirazione	57,80

ESTRATTORE INGRANAGGIO POMPA DI INIEZIONE MOTORI RENAULT, OPEL, NISSAN

Modelli:

Nissan: Interstar

Renault: Espace/Grand Espace IV; Laguna II; Master II; Trafic II; Vel Satis

Opel: Movano-A; Vivaro

Cilindrata: 2.2 dCi/DTi; 2.5 dCi/DTi/CDTi

Codice motore: G9U...; G9T...



CODICE	€/PZ
FG 192/RE13A	135,00

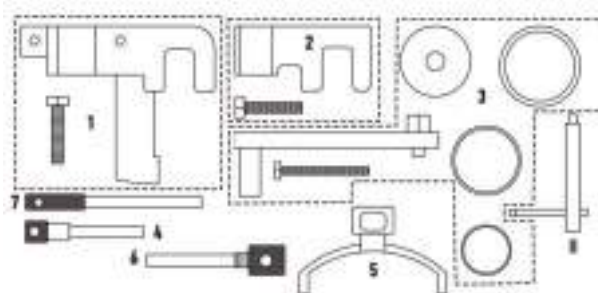

CODICE	n°	Descrizione	€/PZ
FG 192/RE13-1	1	Attezzo di bloccaggio albero a camme di scarico	65,00
FG 192/RE13-2	2	Attezzo di bloccaggio albero a camme di aspirazione	42,50
FG 192/RE13-3	3	Attezzo di tensionamento	115,00
FG 192/RE3-2	4	Perno di fasatura dell'albero motore	9,70
FG 192/RE13-5	5	Attezzo di bloccaggio del pignone della pompa d'iniezione	30,00
FG 192/RE13-6	6	Perno di fasatura albero motore	12,00
FG 192/RE13-7	7	Attezzo allineamento albero motore	9,00
FG 192/RE13-8	8	Attezzo di bloccaggio ingranaggio pompa di iniezione	15,00



SET MESSA IN FASE MOTORI RENAULT 2.0D DCI

Valido per OPEL VIVARO e NISSAN PRIMASTAR

Modelli:

Renault: Scenic, Grand Scenic II, Megane II, Laguna, Espace, Grand Espace, Trafic, Koleos

Nissan: Qashqai, Primastar

Opel: Vauxhall: Vivaro

Cilindrata: 2.0D dCi

Codice motore:

RENAULT: M9R 700, 721, 724, 740, 752, 760, 761, 780, 805, 830, 832, 833

NISSAN: M9R, M9R780

OPEL: M9R780, 750, 752, 753, 760, 761, 766, 782, 800, 801, 812, 813

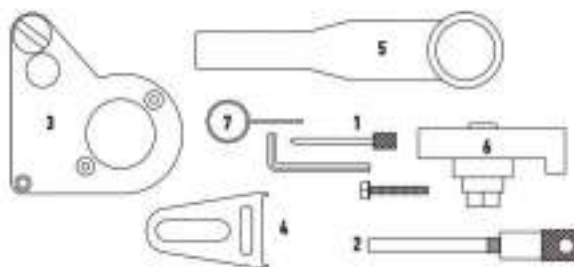

CODICE	€/PZ
FG 192/RE6	240,00

CODICE	n°	Descrizione	€/PZ
FG 192/FT6B-4	1	Perno di bloccaggio tensionatore cinghia ausiliaria (3,60mm)	6,50
FG 192/RE6-2	2	Perno di bloccaggio albero motore	13,10
FG 192/RE6-3	3	Attrezzo bloccaggio/allineamento albero a camme + bullone M6	52,50
FG 192/RE6-4	4	Attrezzo di bloccaggio volano	18,40
FG 192/RE6-5	5	Utensile di tenuta puleggia albero motore	47,30
FG 192/RE6-6	6	Utensile allineamento ingranaggio a due pezzi dell'albero a camme di aspirazione	57,80
FG 192/RE6-7	7	Utensile di tenuta pulegge albero motore (2,90mm)	2,60

UTENSILE BLOCCAGGIO PULEGGIA VAG 1.4 16V E 1.6 16V

Modelli:

Volkswagen: Polo, Lupo, Bora, Golf, Golf Estate, Caddy, Caddy Maxi, Polo Classic, Beetle

Skoda: Fabia, Octavia, Octavia Tour, Octavia II

Seat: Cordoba, Ibiza, Arosatoledo, Leon, Inca - Audi: A2

Cilindrata: 1.4 16V e 1.6 16V

Codice motore: AFH, AFK, AHW, AJV, AKQ, APE, AQQ, ATN, AUA, AUB, AUS, AXP, AZD, BAD, BBY, BBZ, BCA, BCB, BKY



CODICE	€/PZ
FG 192/VW1	58,00

CHIAVE TENDICINGHIA PER MOTORI VW, AUDI, SEAT, SKODA



CODICE	€/PZ
FG 192/VW1B	28,00

CHIAVE TENDICINGHIA PER MOTORI VW, AUDI, SEAT, SKODA DIESEL



CODICE	€/PZ
FG 192/VW1C	30,00

CHIAVE TENDICINGHIA PER MOTORI VW, AUDI, SEAT, SKODA



CODICE	€/PZ
FG 192/VW1D	32,00



CHIAVE TENDICINGHIA PER MOTORI VW, AUDI, SEAT, SKODA



CODICE	€/PZ
FG 192/VW1E	48,00

ATTREZZO BLOCCAGGIO PIGNONE ALBERO A CAMME VW, AUDI, SEAT, SKODA



CODICE	€/PZ
FG 192/VW1F	98,00

SET FASATURA MOTORI AUDI 3.0 V6 A CINGHIA - BENZINA

Modelli: AUDI: A4, A4 Cabrio, A4 quattro, A6, A8



CODICE	€/PZ
FG 192/VW5B	275,00



CODICE	n°	Descrizione	€/PZ
FG 192/VW5B-1	1	Attrezzo bloccaggio albero motore	11,20
FG 192/VW5B-2	2	Attrezzo di registrazione del pignone albero a camme	14,00
FG 192/VW5B-3	3	Perno di bloccaggio del tendicinghia	9,80
FG 192/VW5B-4	4	Attrezzi di bloccaggio albero a camme (2 pezzi)	291,00

SET FASATURA MOTORI VAG 1.0 3 CILINDRI

Modelli:
SEAT: Mii
SKODA: Citigo, Fabia
VOLKSWAGEN: Up, Polo



CODICE	€/PZ
FG 192/VW4B	260,00

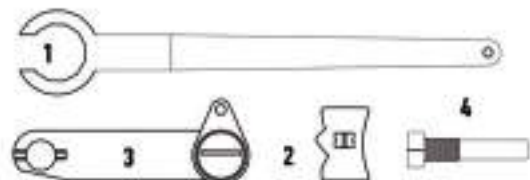

CODICE	n°	Descrizione	€/PZ
FG 192/VW4B-1	1	Attrezzo tensionatore	92,00
FG 192/VW4B-2	2	Attrezzo bloccaggio albero a camme	15,00
FG 192/VW4B-3	3	Attrezzo bloccaggio albero a camme	118,00
FG 192/VW4B-4	4	Attrezzo bloccaggio albero a camme	18,00



UTENSILI PER ALLINEAMENTO ALBERO A CAMME MOTORI VOLKSWAGEN, AUDI, SKODA 1.2 TSI

Modelli: VOLKSWAGEN: Beetle/Maggiolino, Caddy/Caddy Maxi, Golf Plus, Golf VI, Golf VI Cabrio, Golf VI Estate, Jetta, Polo, Touran
 AUDI: A1, A2, A3 Cabrio
 SEAT: Altea/Altea XL, Ibiza, Leon
 SKODA: Fabia II, Octavia, Praktik, Roomster, Yeti
Cilindrata: 1.2 TSI BENZINA
Codice motore: CBZA, CBZB, CBZC



CODICE	€/PZ
FG 192/VW2	75,00

SET FASATURA MOTORI VAG 1.4 FSI, 1.6 FSI, 1.4 TSI, 1.6 16V

Modelli: Volkswagen: Polo; Golf V; Touran; Golf Plus; Eos; Golf Plus; Jetta; Passat; Beetle; Tiguan; Golf VI; Scirocco; Passat; Sharan
 AUDI: A1; A3
 SEAT: Ibiza; Toledo; Leon; Altea; Alhambra; Cordoba
 SKODA: Fabia II; Roomster; Rapid; Rapid Spaceback; Yeti; Octavia II; Superb II
Cilindrata: 1.4 FSI, 1.6 FSI, 1.4 TSI, 1.6 16V
Codice motore: AUX; BKG; BLN; BAG; BLF; BLP; CAVD; CAVA; CAVB; CAVC; CAVE; CTHD; CAXA; CAVA; CAVD; BMY; CDGA; CKMA; CTHA; CTHB; CTHC; BTS; CTHE; CNKA; CFNA



CODICE	€/PZ
FG 192/VW3B	275,00

SET FASATURA MOTORI VAG 1.2 3CILINDRI 6V E 12V

Modelli: Volkswagen: Polo, Fox Seat: Cordoba, Ibiza
 Skoda: Fabia, Roomster
 Seat: Cordoba, Ibiza
Cilindrata: 1.2 3 CIL. 6V e 12V
Codice motore: AWY, BMD, AZQ, BME



CODICE	€/PZ
FG 192/VW4	148,00

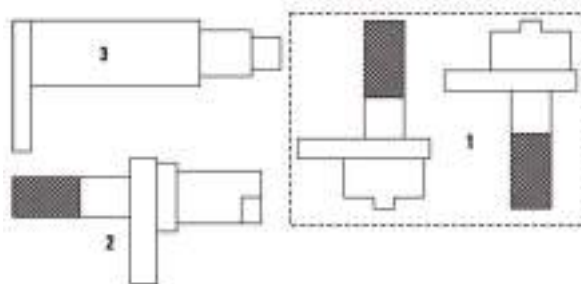

CODICE	n°	Descrizione	€/PZ
FG 192/VW4-1	1	Attrezzo di allineamento albero a camme x 2	41,20
FG 192/VW4-2	2	Attrezzo di allineamento albero a camme	45,80
FG 192/VW4-3	3	Attrezzo di bloccaggio volano	36,60

SET FASATURA MOTORI VAG VAG 1.2/1.4 TSI E TFSI

Modelli: A3, A3 Sportback, A3 Saloon, A3 Cabrio, A3 Sedan, A1, A1 Sportback, Q3 Leon, Leon ST, Ibiza Fabia III, Fabia III Estate, Octavia III, Polo, Jetta, Golf VII, Golf VII Estate, Golf VII Wagon, Passat, Golf SV
Cilindrata: 1,2TSI, 1,2TFSI, 1,4TSI, 1,4TFSI, 1,4 TSI ACT, 1,4GTE, 1,4 GTE Hybrid, 1,4TGI BlueMotion, 1,4g-tron, 1,4e-tron, 1,4TFSI COD
Codice motore: CJZA, CJZB, CJZC, CJZD, CYVD, CYVA, CYVB, CZCA, CXSA, CXSB, CPWA, CHPB, CUKB, CZDA, CPTA, CZEA



CODICE	€/PZ
FG 192/VW4C	315,00

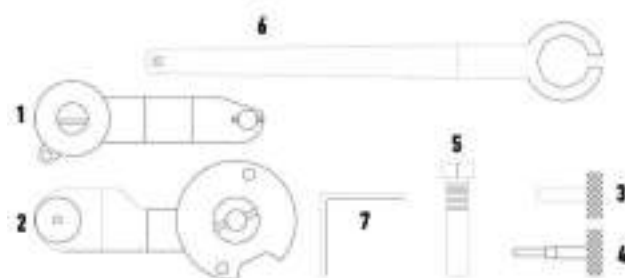

CODICE	n°	Descrizione	€/PZ
FG 192/VW4C-1	1	Attrezzo di fasatura albero a camme	76,00
FG 192/VW4C-2	2	Attrezzo di fasatura albero a camme	86,00
FG 192/VW4C-3	3	Perno bloccaggio albero a camme	11,90
FG 192/VW4C-4	4	Perno di controllo fasatura albero a camme	14,50
FG 192/VW4B-4	5	Attrezzo bloccaggio albero a camme	18,00
FG 192/VW4B-1	1	Attrezzo tensionatore	92,00
FG 192/VW7-4	7	Perno bloccaggio tendicinghia degli organi ausiliari	10,00

SET FASATURA MOTORI VAG 1.8/2.0 TFSI 4V (CATENA)

Modelli:

VW: Tiguan; CC; Golf VI; Passat; Beetle/Maggiolino; Eos; Scirocco.
AUDI: A4; A4 quattro; A5 Coupe/Cabriolet; A5 Sportback; Q5; TT
SKODA: Octavia II; Superb; Yeti

Cilindrata: 1.8 TFSi; 2.0 TFSi

Codice motore: CCZA; CCZB; CCZC; CCZD; CDAA; CDAB; CDHB; CDNC; CFKA; CDNB; CETA; CJEB; CESA; CDHA



CODICE	€/PZ
FG 192/VW8	340,00

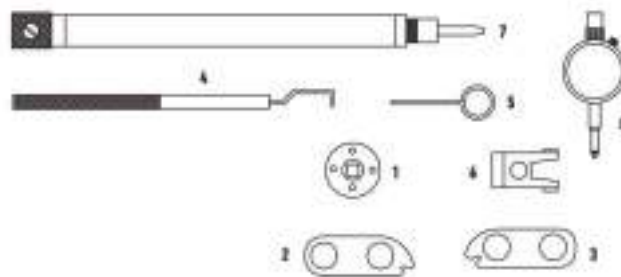

CODICE	n°	Descrizione	€/PZ
FG 192/VW8-1	1	Attrezzo rimozione valvola controllo albero a camme	37,80
FG 192/VW8-2	2	Morsa albero a camme (scarico)	65,00
FG 192/VW8-3	3	Morsa albero a camme (aspirazione)	65,00
FG 192/VW8-4	4	Perno bloccaggio del tenditore della pompa dell'olio	16,00
FG 192/VW8-5	5	Perno di bloccaggio del tenditore 1,4 mm	4,30
FG 192/VW8-6	6	Tenditore catena di distribuzione	5,40
FG 192/PM	7	Indicatore PMS	82,00
FG 192/CO	8	Comparatore	102,00

UTENSILE ASSEMBLAGGIO PULEGGIA ALBERO MOTORE VAG 1.8/2.0 TFSI 4V



CODICE	€/PZ
FG 192/VW8C	330,00

UTENSILE PER INSERIMENTO GUARNIZIONE ALBERO MOTORE VAG 1.8/2.0 TFSI 4V



CODICE	€/PZ
FG 192/VW8D	480,00

SET CHIAVI SMONTAGGIO VALVOLA REGOLAZIONE DEL DISPOSITIVO REGISTRAZIONE ALBERO A CAMME MOTORI VAG

Modelli: AUDI: A3; A4; A5 Cabriolet; A5 Coupe; Q5

VOLKSWAGEN: Passat

Codice motore: BYT; BZB; CABA; CABB; CBFA; CAWB; CDAA; CDAB



CODICE	€/PZ
FG 192/VW8E	110,00

UTENSILE BLOCCAGGIO PULEGGIA ALBERO MOTORE VAG 1.8/2.0 TFSI 4V (CATENA)



CODICE	€/PZ
FG 192/VW8B	120,00



SET FASATURA MOTORI VW/AUDI 2.0 FSI & TFSI

Modelli:

AUDI: A3, A4, TT, A4 Cabrio, S3

VOLKSWAGEN: Golf VI, Touran, Passat, Eos, Jetta, Golf Plus, Scirocco, Golf V

Cilindrata: 2.0, 2.0 FSI, 2.0 TFSI

Codice motore: AXW, BHD, BMB, AWA, AXX, BPY, BWA, BUL, BPJ, BGB, BWE, BLR, BLX, BLY, BVY, BWT, BPG, CDLA, CDLB, CDLC, CDMA, AXW, CDLF



SET FASATURA MOTORI VAG 1.8 E 1.8T

Modelli:

AUDI: A3; S3; TT ;A6 - VW: Golf; Passat

SEAT: Ibiza; Cordoba ; Leon; Toledo; Alhambra Octavia

Cilindrata: 1.8, 1.8 T benzina

Codice motore: ADR, AEB, AFY, AGN, AGU, AJH, AJL, AJP, AJQ, AMK, AMU, ANB, APG, APH, APP, APT, APU, APX, APY, AQA, AQX, AGR, ARX, ARY, ARZ, ATC, ATW, AUM, AUQ, AVC, AWC, AWP, AWU, AYW, AYP, BAM, BEA, BFV, BKF, BNU, BVP, BVR



CODICE

FG 192/VW7C

€/PZ

205,00

CODICE

FG 192/VW5

€/PZ

40,00

SET FASATURA AUDI 2.5 TFSI / RS PLUS

Modelli:

RS Q3; Q3; TT

Cilindrata: 2.5 TFSI / RS PLUS

Codici motore: CZGA; CZGB; CEPA; CEPB; CTSA

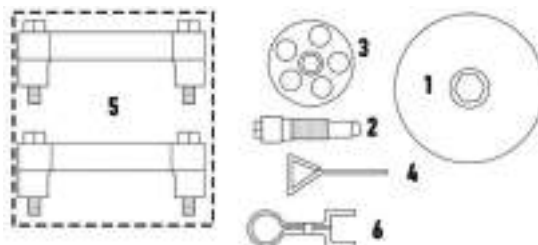

CODICE

FG 192/VW7D

€/PZ

360,00

CODICE	n°	Descrizione	€/PZ
FG 192/VW7D-1	1	Attrezzi bloccaggio dispositivo registrazione albero a camme	50,00
FG 192/VW7D-2	2	Perno allineamento albero motore	13,90
FG 192/VW7D-3	3	Adattatore del bullone della puleggia dell'albero motore	85,00
FG 192/VW7-5	4	Perno bloccaggio tendicatena (3 pezzi)	7,10
FG 192/VW7D-5	5	Attrezzo bloccaggio albero a camme (2 pezzi)	195,00
FG 192/VW7D-6	6	Perno bloccaggio tendicatena (2 pezzi)	11,50

SET FASATURA VW 1.2, 1.4, 1.6, 1.9, 2.0D TDI PD

Modelli:

Volkswagen: Bora, Golf, Golf Estate, Golf Plus, Passat, Lupo, Polo, Sharan, Beetle, Touran, Transporter, Jetta, Caddy, Caddy Maxi, Eos

Audi: A2, A3, A4, A4 Cabrio, A4 Quattro, A6

Seat: Arosa, Cordoba, Ibiza, Alhambra, Leon, Toledo, Altea, Altea XL

Skoda: Fabia, Octavia, Octavia Tour, Octavia li, Superb, Roomster

Cilindrata: 1.2D TDI PD, 1.4D TDI PD, 1.6D TDI PD, 1.9D TDI PD, 2.0D TDI PD

Codici motore: AJM, AMF, ANU, ANY, ARL, ASZ, ATD, ATJ, ATL, AUY, AVB, AVF, AVQ, AWX, AXB, AXC, AXR, AYZ, AZV, BAY, BDJ, BDK, BGW,BHC, BHW, BJB, BKC, BKD, BKE, BKP,BKQ, BLB, BLS,BLT, BMA, BMM, BMN, BMP, BMR, BMS, BMT, BNA, BNM,BNV, BPW,BPX, BRA,BR-B,BRC,BRE, BRF, BRM,BRT, BRU, BSS, BSV,BSU,BSW, BTB, BUK, BUY, BUZ, BVA, BVE, BVF, BVG, BVH,BVK, BWV, BXE, BXF



CODICE	€/PZ
FG 192/VW7	150,00

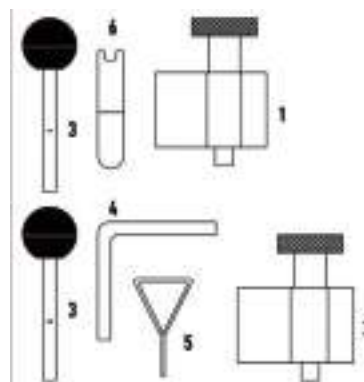

CODICE	n°	Descrizione	€/PZ
FG 192/VW14-2	1	Attrezzo bloccaggio del pignone tondo albero motore	39,00
FG 192/VW7-2	2	Attrezzo bloccaggio del pignone ovale albero motore	35,60
FG 192/VW7-3	3	Attrezzo di bloccaggio albero a camme (2 pezzi)	14,20
FG 192/VW7-4	4	Perno bloccaggio del tendicinghia della cinghia organi ausiliari	10,00
FG 192/VW7-5	5	Perno bloccaggio della puleggia del tendicinghia	7,10
FG 192/FO24-15	6	Chiave a due denti	3,20

SET FASATURA NUOVI MOTORI VAG 1.4, 1.6, 2.0 TDI CR

Modelli:

Volkswagen: Golf VII, Golf VII Estate, Golf VII Wagon, Polo

Audi: A3 Cabrio, A3 Saloon, A3/A3 Sportback, A4, A4 allroad, A4 quattro, A5 Coupe/ Cabriolet, A5 Sportback, A6, Q5, TT

Seat: Leon, Leon ST

Skoda: Octavia III

Cilindrata: 1.4TDI CR, 1.6TDI CR, 1.6TDI CR GreenLine/BlueMotion/Ecomotive 2.0TDI CR / RS TDI / TDI CR Ultra

Codici motore: CKFB, CKFC, CLHA, CLHB, CNHA, CNHC, CRBC, CRBD, CRFA, CRFC, CRKA, CRKB, CRLB, CRLC, CRMB, CRVA, CRVC, CSUA, CSUB, CUNA, CUPA, CUTA, CUSA, CUSB



CODICE	€/PZ
FG 192/VW10B	380,00

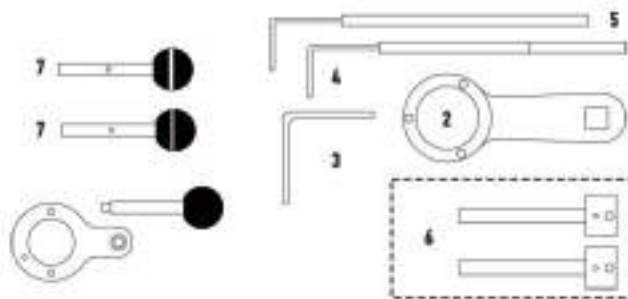

CODICE	n°	Descrizione	€/PZ
FG 192/VW10B-1	1	Attrezzo bloccaggio pignone albero motore	145,00
FG 192/VW10-7	2	Attrezzo bloccaggio pignone pompa del carburante ad alta pressione	70,00
FG 192/VW7-4	3	Perno bloccaggio tendicinghia della cinghia organi ausiliari	10,00
FG 192/VW10-6	4	Attrezzo di registrazione puleggia del tendicinghia	15,00
FG 192/VW10-5	5	Attrezzo bloccaggio puleggia del tendicinghia	15,00
FG 192/VW10B-6	6	Perno bloccaggio pompa carburante alta pressione	72,50
FG 192/FO24-14	7	Attrezzo di bloccaggio albero a camme	14,20



SET FASATURA MOTORI VAG & FORD

Modelli:

Volkswagen: Transporter, Caddy, Golf, Golf Estate, Passat, Polo, Polo Classic, Polo Estate, Sharan, Vento, Bora, Beetle, Lupo

Audi: 80, 90, 100, A6, A3, A4, A8, Allroad

Seat: Cordoba, Ibiza, Toledo, Alhambra, Inca, Arosa

Skoda: Felicia, Van, Pick, Up, Octavia, Octavia Tour, Fabia

Ford: Galaxy

Cilindrata: 1.2D TDI PD, 1.4D TDI PD, 1.6, 1.6D, 1.6D TURBO, 1.7D SDI, 1.8, 1.8 TURBO, 1.9D, 1.9D TURBO, 1.9D TDI, 1.9D TDI PD, 2.0, 2.4D, 2.5D TDI, 2.5D SDI, 3.7, 4.2

Codici motore: 1X, 1Y, 1Z, AAB, AAT, AAZ, ABL, ABZ, ACE, ACV, ADP, ADR, AEB, AEF, AEL, AEW, AEW, AFB, AFF, AFN, AGD, AGP, AGR, AGX, AHB, AHC, AHD, AHF, AHH, AHL, AHU, AJA, AJM, AKE, AKN, AKU, AKW, ALE, ALH, ALT, AMF, ANU, ANY, AQM, ARL, ASV, ASX, ASZ, ATD, ATJ, AUY, AVB, AVF, AVG, AVJ, AWX, AXR, AYM, AYZ, BAY, CY, JK, RA, SB,

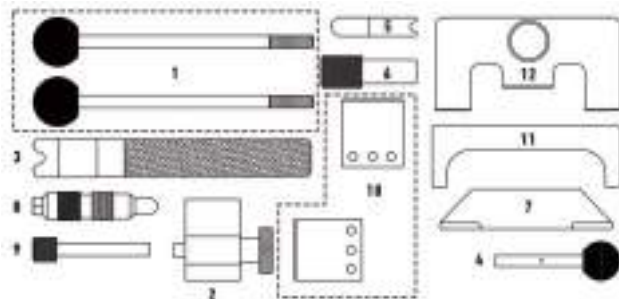

CODICE	€/PZ
FG 192/VW14	320,00

CODICE	n°	Descrizione	€/PZ
FG 192/VW14-1	1	Guide 8 mm (2 pz)	31,20
FG 192/VW14-2	2	Attrezzo bloccaggio del pignone albero motore	39,00
FG 192/VW14-3	3	Chiave a due denti	46,80
FG 192/FO24-14	4	Attrezzo bloccaggio albero a camme	14,20
FG 192/FO24-15	5	Chiave bloccaggio del tendicinghia	3,20
FG 192/VW14-6	6	Perno di bloccaggio del pignone pompa d'iniezione	11,70
FG 192/VW14-7	7	Barra di bloccaggio albero a camme	19,50
FG 192/VW14-8	8	Attrezzo bloccaggio albero motore	15,60
FG 192/VW14-9	9	Perno di bloccaggio	7,80
FG 192/VW14-10	10	Attrezzi allineamento albero a camme	23,40
FG 192/FO24-13	11	Barra di bloccaggio albero a camme	8,10
FG 192/VW14-12	12	Barra di bloccaggio albero a camme	31,20

SET FASATURA MOTORI VW, AUDI, SEAT, SKODA 1.6, 2.0 TDI CR

Modelli:

VW: Beetle/Maggiolino; Golf V; Golf VI Cabrio; Golf VI Estate; Golf Plus; Passat; Polo; Jetta; Touran; Caddy/Caddy Maxi AUDI: Q5; A1; A3; A3 Cabrio; A4; A4 allroad; A4 quattro; A5 Coupe/Cabriolet; A5 Sportback; A6

SEAT: Ibiza; Leon; Altea / Altea XL; Toledo; Exeo

SKODA: Fabia II; Octavia II; Rapid; Praktik; Yeti; Roomster; Superb II

Cilindrata: 1.6, 2.0 TDI CR (diesel a cinghia)

Codice motore: CAYB; CAYC; CAYA; CAGA; CAGB; CAGC; CAHA; CAHB; CFHC; CBAA; CBAB; CFFB; CGLA; CGLB; CAAA; CAAB; CAAC; CBAB; CBAC; CBBA; CBBB; CBDA; CBDB; CBDC; CFJA; CFWA; CJCA; CJCB; CJAA; CCHA; CEGA

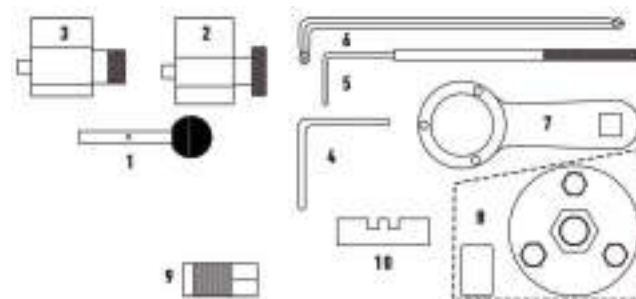

CODICE	€/PZ
FG 192/VW10	320,00

CODICE	n°	Descrizione	€/PZ
FG 192/FO24-14	1	Attrezzo bloccaggio albero a camme/pompa del carburante ad alta pressione	14,20
FG 192/VW10-2	2	Attrezzo di bloccaggio del pignone albero motore	38,00
FG 192/VW10-3	3	Attrezzo di bloccaggio del pignone albero motore	27,00
FG 192/VW7-4	4	Perno bloccaggio tendicinghia della cinghia organi ausiliari (3,9 mm)	10,00
FG 192/VW10-5	5	Attrezzo di bloccaggio della puleggia del tendicinghia	15,00
FG 192/VW10-6	6	Attrezzo registrazione puleggia del tendicinghia	15,00
FG 192/VW10-7	7	Attrezzo bloccaggio mozzo pignone albero a camme	70,00
FG 192/VW10-8	8	Estrattore mozzo pignone albero a camme	82,00
FG 192/VW10-9	9	Estrattore mozzo pignone albero a camme	19,00
FG 192/VW10-10	10	Attrezzo di bloccaggio albero equilibratore	15,00



SET RIMONTAGGIO ALBERI A CAMME ALL'INTERNO DELLA TESTATA MOTORI VW, AUDI, SEAT, SKODA 1.6, 2.0 TDI CR

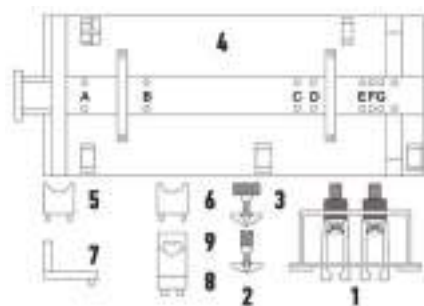

CODICE	€/PZ
FG 192/VW11	1.660,00

CODICE	n°	Descrizione	€/PZ
FG 192/VW11-1	1	Attrezzo bloccaggio alberi a camme	270,00
FG 192/VW11-2	2	Attrezzo allineamento ingranaggio a due pezzi dell'albero a camme di scarico	91,00
FG 192/VW11-3	3	Attrezzo di allineamento ingranaggio a due pezzi	100,00
FG 192/VW11-4	4	Piastra base attrezzo di allineamento alberi a camme	930,00
FG 192/VW11-5	5	Supporto attrezzo di allineamento alberi a camme	36,00
FG 192/VW11-6	6	Supporto attrezzo di allineamento alberi a camme	35,00
FG 192/VW11-7	7	Supporto attrezzo di allineamento alberi a camme	65,00
FG 192/VW11-8	8	Supporto attrezzo di allineamento alberi a camme	75,00
FG 192/VW11-9	9	Supporto attrezzo di allineamento alberi a camme	75,00

SET FASATURA MOTORI VOLKSWAGEN 2.4, 2.5 TDI

Modelli:

LT; Craer; Transporter T4

Cilindrata: 2.4, 2.5 Tdi

Codici motore: ANJ; BJJ; BJK; BJL; BJM; AAB; AJA

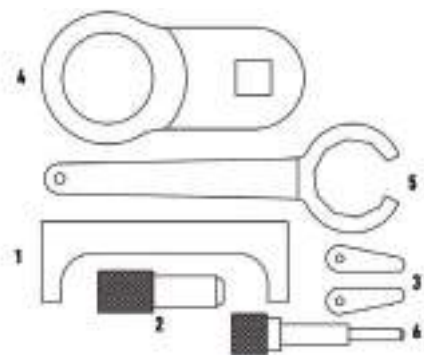

CODICE	€/PZ
FG 192/VW7B	192,00

CODICE	n°	Descrizione	€/PZ
FG 192/FO24-13	1	Barra di bloccaggio albero a camme	8,10
FG 192/FO24-12	2	Perno bloccaggio pignone pompa iniezione Ø15.4 mm	8,10
FG 192/FO24-8	3	Spessori	12,90
FG 192/VW7B-4	4	Attrezzo di bloccaggio della puleggia albero motore	94,90
FG 192/VW7B-5	5	Chiave per la puleggia del tendicinghia	57,60
FG 192/VW7B-6	6	Perno di fasatura albero motore	16,90

SET FASATURA MOTORI VAG 2.5 TDI V6 - A CHINGHIA

Modelli:

Volkswagen: Passat

Audi: A4; A4 quattro; A6; A6 quattro; A8; Allroad; A4 Cabrio

Skoda: Superb

Cilindrata: 2.5 Tdi

Codici motore: AFB; BAU; AKE; AKN; BDG; BDH; AFB; BAU; AKE; AKN; AYM; BCZ; BDG; BDH; BFC; AYM; BDG

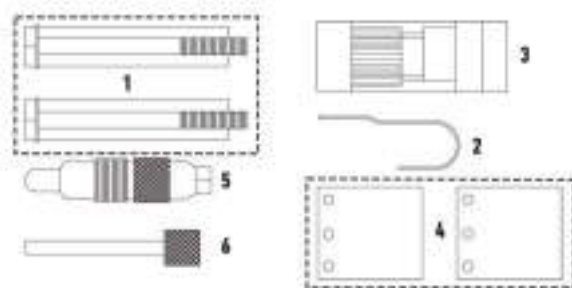

CODICE	€/PZ
FG 192/VW9	165,00

CODICE	n°	Descrizione	€/PZ
FG 192/VW9-1	1	Guide di supporto	55,00
FG 192/VW9-2	2	Perno bloccaggio tendicinghia	2,00
FG 192/VW9-3	3	Chiave per tendicinghia	36,00
FG 192/VW9-4	4	Attrezzo di allineamento albero a camme	20,00
FG 192/VW9-5	5	Attrezzo di bloccaggio albero motore	13,00
FG 192/VW14-9	6	Perno di bloccaggio della pompa d'iniezione	7,80



SET FASATURA MOTORI VOLKSWAGEN 2.5 TDI PD

Modelli: Transporter, Tuareg

Cilindrata: 2.5 TDI PD

Codici motore: AXD; AXE; BAC; BLJ; BLK; BNZ; BPC; BPD; BPE

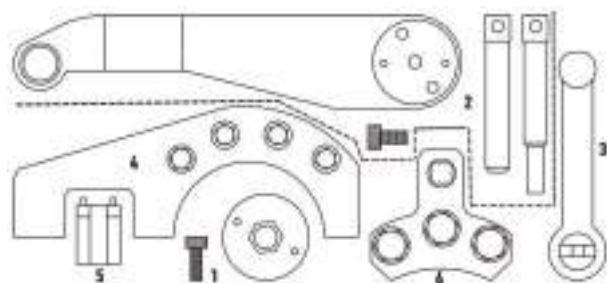

CODICE	n°	Descrizione	€/PZ
FG 192/VW6-1	1	Attrezzo di allineamento albero motore	22,40
FG 192/VW6-2	2	Attrezzo di bloccaggio albero motore	100,70
FG 192/VW6-3	3	Attrezzo di allineamento albero a camme	22,40
FG 192/VW6-4	4	Attrezzo di bloccaggio ingranaggio albero a camme	209,70
FG 192/VW6-5	5	Attrezzo di pretensionamento ingranaggio di compensazione albero a camme	41,90
FG 192/VW6-6	6	Attrezzo di bloccaggio barra rotazione ingranaggio albero a camme	106,30

CODICE	€/PZ
FG 192/VW6	530,00

SET RIMOZIONE POMPA DELL'ACQUA MOTORI VOLKSWAGEN 2.5 TDI PD

Modelli:

Transporter, Transporter T5, Touareg

Cilindrata: 2.5 TDI PD

Codici motore: AXD, AXE, BAC, BLJ, BLK, BNZ, BPC, BPD

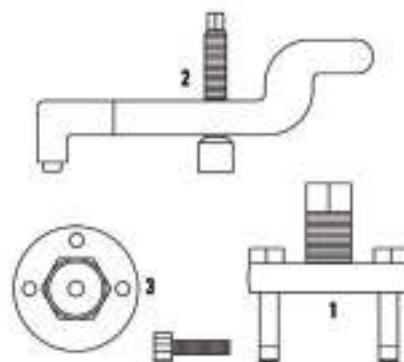

CODICE	n°	Descrizione	€/PZ
FG 192/VW6B-1	1	Estrattore ingranaggio (per rimuovere l'ingranaggio dalla pompa dell'acqua)	65,00
FG 192/VW6B-2	2	Estrattore pompa dell'acqua	107,00
FG 192/VW6B-3	3	Attrezzo di allineamento albero motore	48,00

CODICE	€/PZ
FG 192/VW6B	195,00



UTENSILE SUPPORTO PULEGGIA ALBERO MOTORE ADATTO PER MOTORI VOLVO DIESEL

Modelli: C30, C70, S40, V50, C30 D5, C70 D5, S60, V70, XC70 Turbo
Cilindrata: 2.0 D, 2.3 D, 2.4D, 2.5D, 2.8D, 2.9D

Codici motore: D5244T9, D5244T8, D5244T7, D5244T6, D5244T5, D5244T4, D5244T3, D5244T2, D5244T19, D5244T18, D5244T17, D5244T16, D5244T15, D5244T13, D5244T11, D5244T10, D5244T, D5204T7, B6304S3, B6294T, B6294S2, B6294S, B5254T7, B5254T8, B5254T3, B5254T2, B5254T11, B5254T10, B5244T7, B5244SG2, B5244SG, B5244S7, B5244S5, B5234T9, B5234T8, B5234T7, B5234T3, B5204T5, B5204T4, B5204T3



CODICE	€/PZ
FG 192/V01	102,00

SET FASATURA MOTORI VOLVO 2.0 DIESEL

Modelli: VOLVO: S60 II ; V40 ; V90 II ; XC60 ; XC40 ; XC70 ; XC90
Cilindrata: 2.0
Codice motore: D4204T...



CODICE	€/PZ
FG 192/V03	245,00

SET FASATURA MOTORI VOLKSWAGEN/AUDI 2.7D, 3.0D TDI V6, 4.0D, 4.2D TDI V8 (CATENA DELLA DISTRIBUZIONE)

Modelli: AUDI: A4 , A4 Cabrio, A6, A6 allroad, A5 Coupe/Cabriolet, A5 Sportback, A8, Q7, Q5, A5 Coupe/Cabriolet

Cilindrata: 2.7TDI, 2.7TDI CR, 3.0TDI, 3.0TDI CR, 4.0TDI CR, 4.2TDI CR

Codici motore: BPP, BSG, CAMA, CAMB, CANA, CANB, CANC, CAND, CGKA, CGKB, ASB, BKN, BMK, BMZ, BNG, BUG, CAPA: CASA, CASB, CCLA, CCMA, CCWA, CCWB, CDTA, CDTB, CDUC, CDYA, CDYB, CDYC, CJGA, CJGC, CKVB, CKVB, CKVC, CLAA, CLAB, CLZB, ASE, BVN, CDSB, CCFA, BTR



CODICE	€/PZ
FG 192/VW12	330,00



SET FASATURA MOTORI VAG/PORSCHE 2.5, 2.8, 3.2 FSI E 3.0 TFSI

Modelli:

PORSCHE: Cayenne, Panamera

Volkswagen: Touareg

AUDI: A4, A5, A6, A7, A8, Q5, Q7, S4, S5, SQ5

Cilindrata: 2.5 FSI; 2.8 FSI; 3.2 FSI; 3.0 TFSI; 3.0 Hybrid S; 3.0 TSI Hybrid

Codici motore:

PORSCHE: M06/EC; CGEA

Volkswagen: CGFA; CJTA; CGEA

AUDI: CREA; CREC; CRED; CHMB; CGWD; CGXB; CHMA; CTTA; CTUA; CTVA; CTWA; CTWB; CGWC; CTXA; CTUD; CALA; BDX; CCDA; CCEA; CALB;



CODICE	€/PZ
FG 192/VW5C	280,00

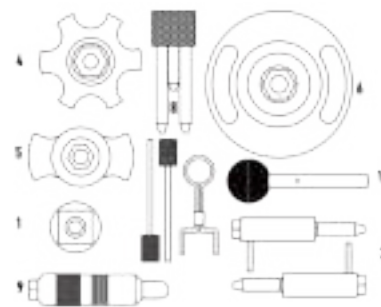

CODICE	n°	Descrizione	€/PZ
FG 192/VW12-1	1	Attrezzo di rotazione albero motore (TIPO 1)	17,80
FG 192/VW12-2	2	Perno di bloccaggio albero a camme (2 pezzi)	21,40
FG 192/VW12-3	3	Perno bloccaggio stantuffo tendicateni (Ø 3.3mm) - (2pz)	14,20
FG 192/VW12-4	4	Attrezzo di allineamento/bloccaggio albero a camme	60,50
FG 192/VW12-5	5	Attrezzo di bloccaggio pignone albero a camme	71,20
FG 192/VW12-6	6	Attrezzo di rotazione albero motore (TIPO 2)	71,20
FG 192/VW12-7	7	Perno di bloccaggio tendicateni (3 pezzi)	21,40
FG 192/VW12-8	8	Attrezzo bloccaggio pignone pompa carburante ad alta pressione	26,70
FG 192/VW14-8	9	Attrezzo bloccaggio albero motore	15,60
FG 192/FO24-14	10	Attrezzo bloccaggio albero equilibratore pompa di iniezione	14,20



ESTRATTORE DELLA PULEGGIA DELL'ALBERO A CAMME MOTORI VAG / PORSCHE

Modelli: A6; A5; A8; Q5; Q7; Touareg; CAYENNE

Cilindrata: 2.7; 3.0

Codice motore: PORSCHE: M05/9E; M05/9D (CAS)

VAG: BMK; CARA; CEXA; BKS; BUN; CASA; CASB; CASC; CATA; CANA; BPP; CCWA; CCWB



CODICE	€/PZ
FG 192/VW12A	70,00

SET FASATURA MOTORI PORSCHE BENZINA M96

Cilindrata: 2.5; 3.2; 3.4

Codice motore: M96/01; M96/01S; M96/20; M96/2



CODICE	€/PZ
FG 192/PR6	130,00

SET FASATURA MOTORI PORSCHE BENZINA M96 E M97

Modelli: 911 (2001-2008); BOXSTER (2002-2011); CAYMAN (2006-2009)

Cilindrata: 2.7, 3.2, 3.4, 3.6, 3.8

Codice motore: M96/03; M96/05; M96/23; M96/25; M96/24; M96/26; M97/01;

M97/20; M97/21; M97/22



CODICE	€/PZ
FG 192/PR4	230,00

SET FASATURA MOTORI VAG/PORSCHE BENZINA 6 E 8 CILINDRI FSI

Modelli:

VAG: TOUAREG; PASSAT; BORA; GOLF; Q7; A8; S8; A3

PORSCHE: CAYENNE

Cilindrata: PORSCHE: 3.6 benzina; VAG: 2.8 ~ 6.3

Codice motore: M55/1; M55/2



CODICE	€/PZ
FG 192/PR5	360,00

SET FASATURA MOTORI PORSCHE M48 BENZINA

Modelli: CAYENNE

Cilindrata: 4.5 e 4.8

Codice motore: 4.5:M48/00; M48/50; M48/50S;M48/50T 4.8: M48/01G; M48/01;

M48/51; M48/51S; M48/51T



CODICE	€/PZ
FG 192/PR8	850,00

ESTRATTORI PIGNONE POMPA DEL CARBURANTE ALTA PRESSIONE MOTORI HYUNDAI/KIA

Modelli: Hyundai: Matrix; Accent/Excel; Getz; i10; Elantra; i30; i20; ix35;

ix20; i40; i20 Coupe; Tucson

Kia: Cerato; Rio; Picanto; Cee'd; Pro-Cee'd; Soul; Venga; Sportage; Carens; Optima

Cilindrata: 1.1 CRDi; 1.4 CRDi; 1.5 CRDi; 1.6 CRDi; 1.7 CRDi

Codici motore: D3FF; D3FA; D4FC; D4FA; D4FB-H (U2); D4FB-L (U2); D4FB-H (U1)



CODICE	€/PZ
FG 192/HI7	195,00

ATTREZZO BLOCCAGGIO VOLANO MOTORI DIESEL HYUNDAI / KIA



CODICE	€/PZ
FG 192/HI7B	90,00

ATTREZZO BLOCCAGGIO VOLANO MOTORI MOTORI HYUNDAI/KIA

Modelli: HYUNDAI: Accent; Elantra; Genesis Coupe; Grand Santa Fe; H1/H300; i10; i20; i30; i40; i800; ix20; ix35; Santa Fe; Sonata; Sonica; Tucson; Tiburon
KIA: Venga; Sportage; Sorento; Soul; Rio; Pro-Cee'd; Picanto; Optima; Carens
Cilindrata: 1.0; 1.2; 1.25; 1.4; 1.6; 2.0; 2.2; 2.4; 2.7
Codici motore: G3LA; B3LA; G3LC; G4LA; G4; G4LA; G4LC; G4FA; G4FA-L; G4FC; G4FCGL; G4FDG4FJ; G4KD; G4KF; G4NC; G4NA; G4ND; G4NE; DAHA-H; D4HA-L; D4HA; D4HB; G4KE; G4KJ; G6BA



CODICE	€/PZ
FG 192/HI2	132,00

COPPIA DI CHIAVI A FORCHETTA 41MM PER POMPA DELL'ACQUA MOTORI CHEVROLET, DAEWOO

Modelli:
 Chevrolet: Aveo, Cruze, Kalos, Lacetti, Nubira, Tacuma/Rezzo
 Daewoo: Kalos, Lacetti, Lanos, Nexia/Cielo/Racer, Nubira, Tacuma/Rezzo
Cilindrata: 1.4, 1.5, 1.6, 1.8
Codici motore: F14D3, F16D3, A16DMS, G15MF, A15MF, F14S3, A15DM, A15SMS, A16DM, F18N



CODICE	€/PZ
FG 192/DW2	105,00

ESTRATTORE PIGNONE POMPA CARBURANTE ALTA PRESSIONE MOTORI HYUNDAI/KIA

Modelli:
 Hyundai: Tucson, ix35, Grand Santa Fe, Santa Fe
 Kia: Sorento, Sedona, Carnival, Sportage
Cilindrata:
 2.0 CRDi, 2.2 CRD1
Codici motore:
 D4HA; D4HA-H; D4HA-L; D4HB



CODICE	€/PZ
FG 192/HI1	98,00

SET FASATURA MOTORI HONDA 1.6-3.0 (SOHC E DOHC)

Modelli: Civic; Accord; Prulde; Shuttle; Odyssey
Cilindrata: 1.6, 1.8, 2.0, 2.2; 2.3; 3.0
Codici motore:
 1.6: B16A2
 1.8: F18A3, F18B2, F18B4
 2.0: F20AF, F20B3, F20B5, F20B6, F20B7, F20Z1, F22Z2, F22B5, F22B8, F22A2, H22A5, H22A7, H22A8
 2.3: F23A7, F23Z5, H23A2, H23A3
 3.0: J30A1



CODICE	€/PZ
FG 192/H05	95,00

SET TENDICINGHIA MOTORI HYUNDAI, MITSUBISHI E PROTON

Modelli: Hyundai: Lantra/Elantra; Sonata; Santa Fe; Trajet
 Mitsubishi: 3000 GT; Colt; Lancer; Carisma; Space Star; Pajero Pinin;
 Galant; Space runner; Grandis; Triton
 Proton: Persona: 418; Satria; Wira; M21 Coupe
Cilindrata: 1.6, 1.8, 2.0, 2.4, 3.0, 3.5
Codici motore: 1.6: 4G61, G4-R - 1.8: 4G67, 4G93, 4G93P, G4-N
 2.0: 4G63, 4G94, G4CP, G4JP, G4-P - 2.4: 4G64, 4G69, G4JS
 3.0: 6G72 - 3.5: 6G74



CODICE	€/PZ
FG 192/HI5	60,00



SET FASATURA MOTORI TOYOTA, LEXUS

Modelli:

Toyota: 4-Runner, Auris, Avensis, Camry, Celica, Corolla, Corolla Verso/CombiVan, Dyna, Hiace, Hilux, Landcruiser, Landcruiser/Prado, MR2, Picnic/SportVan, Previa, Prius, RAV4, Starlet, Tarago, Verso, Verso/Sportsvan, Vienta, Yaris

Lexus: GS, IS, LS, LX, RX, SC

Cilindrata: 1.0, 1.3, 1.4, 1.6, 2.0, 2.2, 2.4, 2.5, 2.7, 2.8, 3.0, 3.4, 3.5, 4.7

Codici motore:

1SZ-FE, 2SZ-FE, 4G15, 4G93, 2ZR-FAE, 1ZZ-FE, 2AD-FHV, 2AD-FTV, 1AD-FTV, 1CD-FTV, 1MZ-FE, 4E-FE, 2L, 3ZZ-FE, 4ZZ-FE, 3L, 2TR-FE, 2KD-FTV, 2L-T, 1GR-FE, 5VZ-FE, 5L, 2ZR-FE

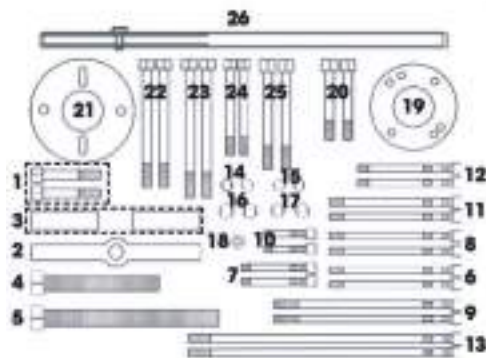

CODICE	€/PZ
FG 192/TY45	610,00

ATTREZZO BLOCCAGGIO PULEGGIA ALBERO MOTORE E ALBERO A CAMME

Modelli:

Lexus: GS; LS; LX; RX

Toyota: Auris; Avensis; Corolla; Aygo; Celica; Corolla Verso/CombiVan

Cilindrata:

1.0; 1.3; 1.4; 1.6; 2.0; 2.2; 2.4; 2.5; 2.7; 2.8; 3.0; 3.4; 3.5; 4.7

Codici motore:

1UZ-FE; 1MZ-FE; 3MZ-FE; 3UZ-FE; 4ZZ-FE; 1CD-FTV; 1ZZ-FE; 3ZZ-FE; 2ZZ-GE; 2KD-FTV; 2KD-FTV H; 2KD-FTV L; 1KD-FTV; 2UZ-FE; 2SZ-FE



CODICE	€/PZ
FG 192/TY15	175,00

CODICE	n°	Descrizione	€/PZ
FG 192/TY45-1	1	Viti M8x55 per estrattore FG 192/TY45-21 (2 pezzi)	2,00
FG 192/TY45-2	2	Estrattore puleggia albero motore	64,00
FG 192/TY45-3	3	Braccio dell'estrattore FG 192/TY45-2 (2 pz)	42,50
FG 192/TY45-4	4	Vite centrale L:100 mm per estrattore FG 192/TY45-2	12,50
FG 192/TY45-5	5	Vite centrale L:150 mm per estrattore FG 192/TY45-2	15,00
FG 192/TY45-6	6	Griffa M5x100 (2 pezzi)	20,00
FG 192/TY45-7	7	Griffa M8X50 (2 pezzi)	12,50
FG 192/TY45-8	8	Griffa M8X100 (2 pezzi)	17,50
FG 192/TY45-9	9	Griffa M8X150 (2 pezzi)	22,50
FG 192/TY45-10	10	Griffa M6X30 (2 pezzi)	10,00
FG 192/TY45-11	11	Griffa M6X100 (2 pezzi)	20,00
FG 192/TY45-12	12	Griffa M8X75 (2 pezzi)	15,00
FG 192/TY45-13	13	Griffa M8X225 (2 pezzi)	25,00
FG 192/TY45-14	14	Adattatore M10X1.25 (2 pezzi)	9,00
FG 192/TY45-15	15	Adattatore M10X1.5 (2 pezzi)	9,00
FG 192/TY45-16	16	Adattatore M12X1.25 (2 pezzi)	9,00
FG 192/TY45-17	17	Adattatore M12X1.5 (2 pezzi)	9,00
FG 192/TY45-18	18	Adattatore	4,00
FG 192/TY45-19	19	Estrattore puleggia albero motore	106,00
FG 192/TY45-20	20	Viti M8x65 per estrattore FG 192/TY45-19 (2 pezzi)	2,00
FG 192/TY45-21	21	Estrattore puleggia albero motore	106,00
FG 192/TY45-22	22	Viti M8x106 per estrattore FG 192/TY45-21 (2 pezzi)	6,50
FG 192/TY45-23	23	Viti M8x116 per estrattore FG 192/TY45-21 (2 pezzi)	4,50
FG 192/TY45-24	24	Viti M6x80 per estrattore FG 192/TY45-21 (2 pezzi)	2,00
FG 192/TY45-25	25	Viti M8x88 per estrattore FG 192/TY45-21 (2 pezzi)	6,50
FG 192/TY45-26	26	Manico universale	55,00

FASANO[®]
TOOLS



SET SMONTAGGIO MAGLIE CATENE DI DISTRIBUZIONE



CODICE	€/PZ
FG 184/S24	463,50

SET PER BLOCCAGGIO PULEGGE DISTRIBUZIONE



CODICE	€/PZ
FG 184/BP	216,50

COMPARATORE UNIVERSALE



CODICE	Range mm	Lettura mm	€/PZ
FG 192/CO	0-8	0.01	102,00

TESTATORE RICERCA PUNTO MORTO SUPERIORE

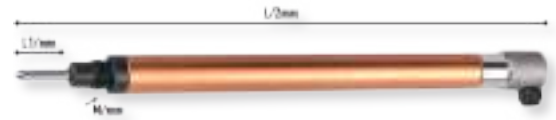

CODICE	M	L1/mm	€/PZ
FG 192/PM	14x1.25	43\@230	82,00

CHIAVE PER ROTAZIONE PULEGGE DI DISTRIBUZIONE

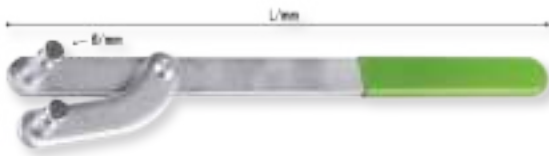

CODICE	L/mm	Ø/mm	€/PZ
FG 184/CP	400	14	77,50

UTENSILE PER MONTAGGIO E SMONTAGGIO CINGHIE ELASTICHE



CODICE	€/PZ
FG 192/CE	78,00

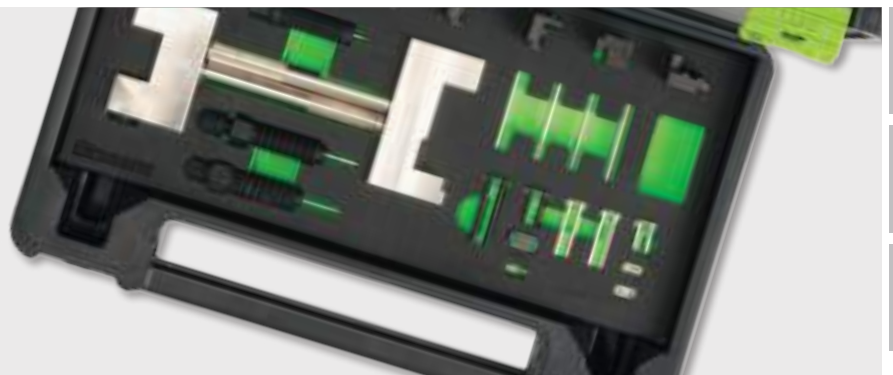

RACCORDI PER OLIO CAMBI AUTOMATICI

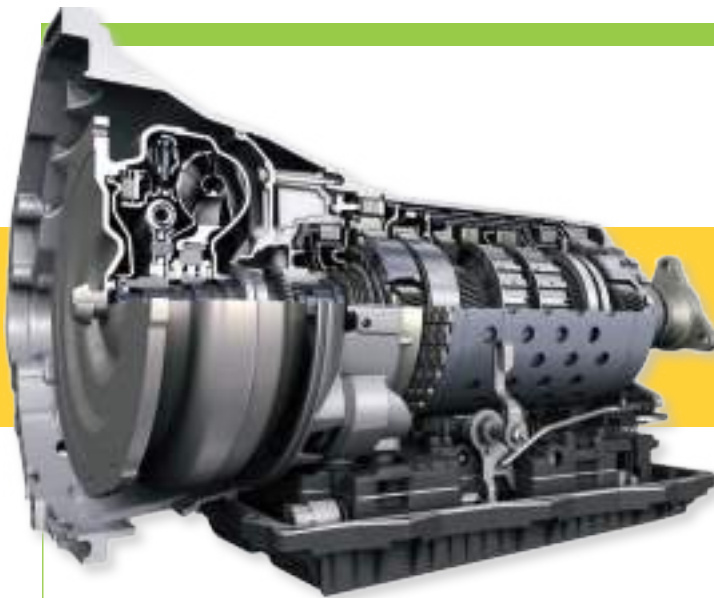

RACCORDO OLIO CAMBIO BMW, VOLVO, AUDI, MERCEDES-BENZ, RENAULT, SAAB, FORD

Applicazione: 09D; 0C8; AF33-5; AF40; AISIN TR60-SN; 09E; AW55-50SN; TR-60SN; 722.9; ZF6HP



CODICE	€/PZ
FG 193/R1	175,00

RACCORDO OLIO CAMBIO BMW, AUDI, RENAULT, SAAB, FORD, RANGE-ROVER, JAGUAR

Applicazione: 09D; 0C8; AF33-5; AF40; AISIN TR60-SN; 09E; AW55-50SN; TR-60SN; 722.9; ZF6HP



CODICE	€/PZ
FG 193/R2	175,00

RACCORDO OLIO CAMBIO AUDI, VW, JEEP

Applicazione: ZF5HP; 0B5; 09L; 0AW; A500; 01V



CODICE	€/PZ
FG 193/R3	42,00

RACCORDO OLIO CAMBIO AUDI, PORSCHE, OPEL, SUBARU, MAZDA, CITROEN, RENAULT, ALFA, LANCIA

Applicazione: AW55-50SN; AF40; TF-81SC; ZF5HP; 6L80; 6L90; TF-80SC; AF21; TF-80SD



CODICE	€/PZ
FG 193/R4	46,00

RACCORDO OLIO CAMBIO JEEP, MITSUBISHI, GM, SUZUKI, TOYOTA

Applicazione: ZF



CODICE	€/PZ
FG 193/R5	18,00

RACCORDO OLIO CAMBIO AUDI, VOLKSWAGEN, PORSCHE, LEXUS, MITSUBISHI

Applicazione: 09G; TF-60SN; 09M; ZF5HP; TF-63SN



CODICE	€/PZ
FG 193/R6	35,00

RACCORDO OLIO CAMBIO JEEP, FIAT, CHRYSLER, MERCEDES-BENZ, SUBARU

Applicazione: 4L60E; 4L65E; 41TE; 41AE; 62TE; WFC280; 5EAT



CODICE	€/PZ
FG 193/R7	24,00

RACCORDO OLIO CAMBIO AUDI, MERCEDES-BENZ, MITSUBISHI

Applicazione: R4A51; V4A51; V5A51; 42RE; 44RE; 45RFE; 5-45RFE; 722.6; 722.9



CODICE	€/PZ
FG 193/R8	35,00

RACCORDO OLIO CAMBIO JAGUAR, MERCEDES-BENZ, SSANGYONG

Applicazione: 722.6; 722.3; 722.4; 722.7



CODICE	€/PZ
FG 193/R9	30,00

RACCORDO OLIO CAMBIO JAGUAR, MERCEDES-BENZ, MITSUBISHI, SSANGYONG

Applicazione: 722.6; 722.3; 722.4; 722.7



CODICE	€/PZ
FG 193/R10	35,00

RACCORDO OLIO CAMBIO JAGUAR, FORD, MAZDA

Applicazione: 5R55E; 5R55S; 5R55N; 5R55W



CODICE	€/PZ
FG 193/R11	24,00

RACCORDO OLIO CAMBIO VOLVO XC60, V60

Applicazione: AISIN con valvola termostatica



CODICE	€/PZ
FG 193/R12	95,00

RACCORDO OLIO CAMBIO VW, AUDI, MITSUBISHI

Applicazione: 09E; 09L; ZF6HP



CODICE	€/PZ
FG 193/R13	46,00

RACCORDO OLIO CAMBIO VOLVO

Applicazione: 42RE; 44RE; 45RFE; A500; 5-45RFE



CODICE	€/PZ
FG 193/R13B	46,00

RACCORDO OLIO CAMBIO FORD, JEEP, DODGE

Applicazione: ZF9HP (9SP)



CODICE	€/PZ
FG 193/R14	52,00

RACCORDO OLIO CAMBIO HYUNDAI, TOYOTA, KIA, MITSUBISHI, ISUZU

Applicazione: A340; A340E; A340H; A341E; A343F; AW 30-40LE; AW30-40LS; A5HF1; F5A51; F5AH1; F4A42 /B; TZ10



CODICE	€/PZ
FG 193/R15	30,00



RACCORDO OLIO CAMBIO MERCEDES-BENZ E RENAULT DCT

Applicazione: K7A240; K7A350; K7X350; 7DCT300



CODICE

FG 193/R16

€/PZ

88,00

RACCORDO OLIO CAMBIO JEEP

Applicazione: 45RFE; 5-45RFE



CODICE

FG 193/R17

€/PZ

30,00

RACCORDO OLIO CAMBIO JEEP, FIAT, ALFA ROMEO, OPEL, CITROEN

Applicazione: AF33-5; 09G; 09M; TF-80SC (AF40); TF-80SD (AF40)



CODICE

FG 193/R18

€/PZ

86,00

RACCORDO OLIO CAMBIO FIAT, PSA, RENAULT

Applicazione: AL4; DPO



CODICE

FG 193/R19

€/PZ

95,00

RACCORDO OLIO CAMBIO AUDI, VW, SEAT, SKODA DSG

Applicazione: DQ250 (02E); DQ500 (08H)



CODICE

FG 193/R20

€/PZ

125,00

RACCORDO OLIO CAMBIO RENAULT, MITSUBISHI, NISSAN

Applicazione: JF613E; RE0F06A



CODICE

FG 193/R21

€/PZ

116,00

RACCORDO OLIO CAMBIO MITSUBISHI

Applicazione: R4A51; R5A51



CODICE

FG 193/R22

€/PZ

58,00

RACCORDO OLIO CAMBIO GM

Applicazione: 42RE; 44RE; 45RFE; A500; 5-45RFE



CODICE

FG 193/R23

€/PZ

46,00

RACCORDO OLIO CAMBIO JEEP, DODGE, OPEL

Applicazione: 42RE; 44RE; 45RFE; A500; 5-45RFE



CODICE

FG 193/R24

€/PZ

28,00

RACCORDO OLIO CAMBIO FORD, RENAULT, PEUGEOT, VOLVO

Applicazione: 6DCT250; 6DCT450/WD; 6DCT451; DD



CODICE

FG 193/R25

€/PZ

105,00

RACCORDO OLIO CAMBIO FIAT, JEEP, LAND-ROVER

Applicazione: ZF09HP



CODICE	€/PZ
FG 193/R26	170,00

RACCORDO OLIO CAMBIO TOYOTA, SUZUKI, MAZDA

Applicazione: K410-411



CODICE	€/PZ
FG 193/R27	135,00

RACCORDO OLIO CAMBIO FIAT, JEEP, LAND-ROVER

Applicazione: 0B5; 0AW; 08HP



CODICE	€/PZ
FG 193/R28	70,00

RACCORDO OLIO CAMBIO JEEP GRAND CHEROKEE, ALFA STELVIO

Applicazione: 8HP70



CODICE	€/PZ
FG 193/R30	128,00

RACCORDO OLIO CAMBIO AUDI, BMW, JAGUAR, LAND-ROVER, ALFA ROMEO, JEEP, IVECO

Applicazione: ZF8HP45; ZF8HP50; ZF8HP55; ZF8HP55AF; ZF8HP65A; ZF8HP70; ZF8HP90; ZF8HP75H



CODICE	€/PZ
FG 193/R31	82,00

RACCORDO OLIO CAMBIO BMW, MINI, VOLVO, PSA

Applicazione: AWF8F45 (BMW/MINI); TG-81 (VOLVO); AT8 - AT6 (PSA)

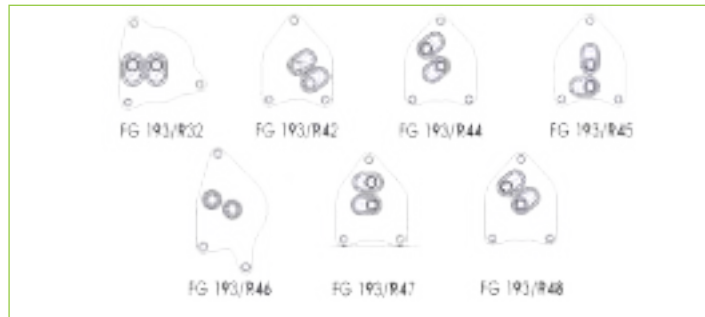

CODICE	€/PZ
FG 193/R32	128,00
FG 193/R42	105,00
FG 193/R44	105,00
FG 193/R45	105,00
FG 193/R46	105,00
FG 193/R47	105,00
FG 193/R48	105,00

SET PIASTRE UNIVERSALI



CODICE	€/PZ
FG 193/R34	93,00

SET 3 PROLUNGHE UNIVERSALI (Ø 10, 13, 15MM)



CODICE	€/PZ
FG 193/R35	58,00



RACCORDO OLIO CAMBIO CITROEN, PEUGEOT

Applicazione: TF-71; TF-81



CODICE	€/PZ
FG 193/R36	105,00

RACCORDO OLIO CAMBIO FIAT, GM, FORD, JEEP, CHRYSLER, SAAB, MERCEDES

Applicazione: 722.9 7G Tronic



CODICE	€/PZ
FG 193/R37	65,00

RACCORDO OLIO CAMBIO AUDI

Applicazione: ZF5HP; 0B5; 09L; 0AW; A500; 01V



CODICE	€/PZ
FG 193/R29	46,00

RACCORDO OLIO CAMBIO BMW, JAGUAR

Applicazione: ZF 6HP



CODICE	€/PZ
FG 193/R38	65,00

RACCORDO OLIO CAMBIO MERCEDES CLK-C, AMG

Applicazione: 722.6 6 Marce



CODICE	€/PZ
FG 193/R39	65,00

RACCORDO OLIO CAMBIO GM

Applicazione: 42RE; 44RE; 45RFE; A500; 5-45RFE



CODICE	€/PZ
FG 193/R33	46,00

RACCORDO OLIO CAMBIO PSA, VW, FIAT DUCATO

Applicazione: ZF 4HP20



CODICE	€/PZ
FG 193/R40	65,00

RACCORDO OLIO CAMBIO BMW

Applicazione: TG-81



CODICE	€/PZ
FG 193/R41	70,00

KIT RACCORDI STANDARD PER OLIO CAMBI AUTOMATICI



CODICE	Contenuto	€/PZ
FG 193/S19	FG 193/R1, FG 193/R2, FG 193/R3, - FG 193/R4, FG 193/R6, FG 193/R7, FG 193/R8, FG 193/R9, FG 193/R10, FG 193/R11, FG 193/R13, FG 193/R14, FG 193/R15, FG 193/R18, FG 193/R20, FG 193/R24, FG 193/R31, FG 193/R34, FG 193/R35	1.280,00

KIT RACCORDI OPTIONAL PER OLIO CAMBI AUTOMATICI



CODICE	Contenuto	€/PZ
FG 193/S10	FG 193/R16, FG 193/R17, FG 193/R19, FG 193/R21, FG 193/R22, FG 193/R25, FG 193/R26, FG 193/R27, FG 193/R28, FG 193/R32	1.050,00

KIT ESTRATTORI MONTAGGIO/SMONTAGGIO CAMBIO AUTOMATICO OAW MULTITRONIC

Estrattore puleggia albero secondario
 Inseritore pignone dierenziale
 Estrattore pignone dierenziale
 Estrattore albero frizione
 Chiave a bussola per dado secondario
 Inseritore paraolio doppio labbro
 Estrattore sensore



CODICE	€/PZ
FG 193/AT1	1.350,00

SUPPORTO DA BANCO PER ALBERO CAMBIO AUTOMATICO OAW MULTITRONIC



CODICE	€/PZ
FG 193/AT1-8	600,00

SET ESTRATTORI PER MONTAGGIO/SMONTAGGIO CAMBIO AUTOMATICO 722.6

Estrattore cuscinetto da statore pompa
 Inseritore cuscinetto statore pompa
 Estrattore molla pistone gruppo B1 Clutch
 Estrattore molla pistone gruppo B2 e K3
 Estrattore molla pistone gruppo B2 e K3
 Estrattore pistone gruppo K1
 Inseritori boccola pompa



CODICE	€/PZ
FG 193/AT2	750,00

SUPPORTO DA BANCO PER ALBERO CAMBIO AUTOMATICO 722.6



CODICE	€/PZ
FG 193/AT2-9	250,00

KIT ESTRATTORI MONTAGGIO/SMONTAGGIO CAMBIO AUTOMATICO 722.8

Estrattore puleggia albero primario
 Estrattore puleggia albero secondario
 Estrattore puleggia albero secondario
 Bussola per dado albero secondario
 Supporto cuscinetto entrata albero secondario



CODICE	€/PZ
FG 193/AT3	980,00

KIT UNIVERSALE PRESSORI PER GRUPPI FRIZIONE CAMBI AUTOMATICI



CODICE	€/PZ
FG 193/UN	1.100,00



UTENSILE INSERIMENTO E RIMOZIONE GRUPPO FRIZIONE DCT



CODICE	€/PZ
FG 193/DCT	160,00

ASTE DI LIVELLO OLIO PER CAMBI AUTOMATICI

Applicazione: Mercedes 722.6



CODICE	€/PZ
FG 193/DS1	35,00

ASTE DI LIVELLO OLIO PER CAMBI AUTOMATICI

Applicazione: Mercedes 722.7, 722.8, 716.S



CODICE	€/PZ
FG 193/DS2	35,00

LEVA PER BLOCCAGGIO/SBLOCCAGGIO GRUPPO MECCATRONICO FRIZIONE CAMBIO AUTOMATICO DSG



CODICE	€/PZ
FG 194/TS	32,00

UTENSILE SMONTAGGIO TAPPO OLIO CAMBIO JAGUAR/LAND ROVER



CODICE	€/PZ
FG 193/ATJ	45,00

UTENSILE PER SCARICO E MISURAZIONE OLIO CAMBIO MERCEDES 9G TRONIC



CODICE	€/PZ
FG 193/MB	65,00

KIT ESTRATTORI CUSCINETTI CAMBI MANUALI GRUPPO VAG



CODICE	€/PZ
FG 193/S4	590,00

SET MONTAGGIO, SMONTAGGIO E REGISTRAZIONE FRIZIONI DSG 7 RAPPORTI A SECCO



CODICE	€/PZ
FG 193DSG/S9	1.050,00

SET MONTAGGIO, SMONTAGGIO FRIZIONI DSG 7 RAPPORTI A SECCO



CODICE	€/PZ
FG 193DSG/S6	695,00

UTENSILI PER SETTORE CARROZZERIA

MARTELLO CON TESTA TONDA PIANA E PENNA



CODICE	Ø/mm	€/PZ
FG 130/TP	40	39,50

MARTELLO CON TESTE TONDA E QUADRATA PIANA



CODICE	Ø/mm	□□/mm	€/PZ
FG 130/TQ	40	38	45,50

MARTELLO CON TESTA TONDA PIANA E QUADRATA ZIGRINATA



CODICE	Ø/mm	□/mm	€/PZ
FG 130/TZQ	40	38	47,50

MARTELLO CON TESTA TONDA PIANA E PUNTA A PENNA SFERICA



CODICE	Ø/mm	€/PZ
FG 130/TPP	40	41,50

TASSO A ROTAIA



CODICE	Misure mm	€/PZ
FG 131/TR	70x62x64	47,50

TASSO A VIRGOLA



CODICE	Misure mm	€/PZ
FG 131/TV	59x130x40	47,50

TASSO A TACCO BOMBATO



CODICE	Misure mm	€/PZ
FG 131/TB	30x78x60	43,50

TASSO CURVO



CODICE	Misure mm	€/PZ
FG 131/TC	30x120x58	47,50

PORTALIMA CON LIMA PIATTA FLESSIBILE A DENTATURA RADIALE



CODICE	Lima	L/mm	€/PZ
FG 131/PL9	9"	360	115,50
FG 131/PL12	12"	360	122,00

LIMA PIATTA FLESSIBILE



CODICE	Lima	L/mm	€/PZ
FG 131/PL9R	9"	360	58,00
FG 131/PL12R	12"	360	64,00

PORTALIMA SENZA LIMA



CODICE	€/PZ
FG 131/PL	58,00



SPATOLA A CUCCHIAIO - MOD. LEGGERO



CODICE	L/mm	€/PZ
FG 131/SC	290	60,00

SPATOLA A CAZZUOLA - MOD. LEGGERO



CODICE	L/mm	€/PZ
FG 131/SCZ	260	51,50

SPATOLA PIANA E CURVA (40°)



CODICE	L/mm	€/PZ
FG 131/SCP	420	91,00

SPATOLA CURVA A GOMITO



CODICE	L/mm	€/PZ
FG 131/SCG	520	111,50



SET 10 UTENSILI PER CARROZZERIA



CODICE	€/PZ
FG 130/S10	598,00

CONTENUTO

	FG 131/TR
	FG 131/TB
	FG 131/TV
	FG 131/TC
	FG 131/SC
	FG 131/SCZ
	FG 131/PL12

KIT PUNZONI IN PLASTICA E BULINO IN ALLUMINIO

1 bulino in alluminio regolabile 70mm-100mm

Filettatura M8x1.25

4 punzoni in gomma dura resistente agli urti e anti-graffio



CODICE	€/PZ
FG 130AL/S5	36,50

SET 3 CUNEI IN PLASTICA

Materiale: Polipropilene ad alta resistenza



CODICE	€/PZ
FG 184P/S3	26,00

SET 3 RASCHIETTI IN ACCIAIO CON MANICO IN ABS



CODICE	L1/mm	L2/mm	€/PZ
FG 184R/S3	280	108, 250, 400	46,50

RASCHIETTO IN ACCIAIO CON MANICO IN ABS



CODICE	L1/mm	L2/mm	€/PZ
FG 184/R1	280	190	21,00

RASCHIETTO IN ACCIAIO CON PROTEZIONE IN PVC E MANICO IN ABS



CODICE	L1/mm	L2/mm	€/PZ
FG 184/R2	275	256	23,00

KIT 4 LEVE PER PARTI IN PLASTICA

Materiale: Nylon e fibra di vetro
Elevata resistenza alla torsione
Dotate di foro per appendimento



CODICE	€/PZ
FG 185P/S4	26,00

KIT CUNEI PER RIMOZIONE MODANATURE IN PLASTICA

Materiale: Polipropilene ad alta resistenza
1pz dotato di manico resistente alle percussioni
1pz senza manico per ideale per spazi ristretti



CODICE	€/PZ
FG 188P/S2	41,50

LEVA PER PARTI IN PLASTICA

Materiale: Nylon e fibra di vetro
Elevata resistenza alla torsione
Dotate di foro per appendimento



CODICE	€/PZ
FG 188/P1	19,00

SET 11 UTENSILI IN NYLON PER CARROZZERIA



CODICE	€/PZ
FG 186/S11	118,50



LEVAPIOLI CON MANICO IN ABS



CODICE	€/PZ
FG 185/A1	21,00

LEVAPIOLI CON MANICO IN ABS



CODICE	€/PZ
FG 185/A5	21,00

LEVAPIOLI CON MANICO IN ABS



CODICE	€/PZ
FG 185/A2	21,00

LEVAPIOLI CON MANICO IN ABS



CODICE	€/PZ
FG 185/A6	16,50

LEVAPIOLI CON MANICO IN ABS



CODICE	€/PZ
FG 185/A3	18,00

LEVAPIOLI CON MANICO IN ABS



CODICE	€/PZ
FG 185/A7	21,00

LEVAPIOLI CON MANICO IN ABS



CODICE	€/PZ
FG 185/A4	19,00

LEVAPIOLI CON MANICO IN ABS



CODICE	€/PZ
FG 185/A8	19,00

SET 5 LEVAPIOLI CON MANICO IN ABS



CODICE	Contenuto	€/PZ
FG 185/S5	FG 185/A1, FG 185/A2, FG 185/A6, FG 185/A7, FG 185/A8	98,00

SET 2 LEVAPIOLI CON MANICO IN ABS



CODICE	€/PZ
FG 185B/S2	41,50

LEVAPIOLI CON LAMA IN ACCIAIO INOX

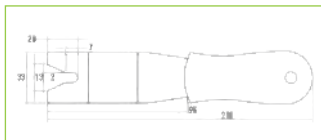

CODICE	€/PZ
FG 186/A1	22,00

LEVAPIOLI CON LAMA IN ACCIAIO INOX

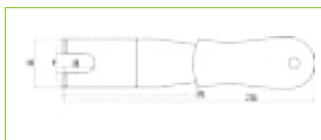

CODICE	€/PZ
FG 186/A2	22,00

LEVAPIOLI CON LAMA IN ACCIAIO INOX

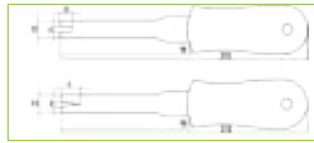

CODICE	€/PZ
FG 186/A3	18,50

LEVAPIOLI CON LAMA IN ACCIAIO INOX

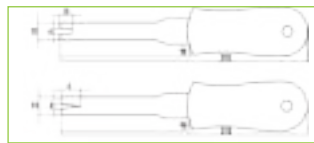

CODICE	€/PZ
FG 186/A4	17,00

LEVAPIOLI CON LAMA IN ACCIAIO INOX

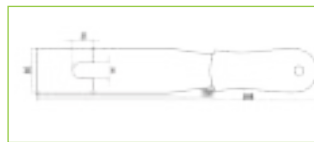

CODICE	€/PZ
FG 186/A5	25,00

SET 5 LEVAPIOLI CON LAMA IN ACCIAIO INOX



CODICE	€/PZ
FG 186/S5	98,00



SET 5 LEVAPIOLI IN NYLON RIMOZIONE PIOLI



CODICE	€/PZ
FG 186P/S5	37,50

LEVA EXTRA PIATTA IN METALLO

Design unico della lama con un lato curvo ed uno dritto per la rimozione di elementi di fissaggio interni ed esterni anche negli spazi più stretti
Punta sottile ad alta resistenza

NEW



CODICE	€/PZ
FG 186/AL1	25,00

PINZA LEVA PIOLI



CODICE	€/PZ
FG 186/LP	36,50

SET 3 LEVERINI IN MATERIALE PLASTICO



CODICE	€/PZ
FG 186/S3	10,00

SET 3 UNCINI IN MATERIALE PLASTICO



CODICE	€/PZ
FG 186/S3B	12,00

SET 4 UNCINI CON LAMA IN ACCIAIO

Con impugnatura bimateriale

NEW



CODICE	€/PZ
FG 186/S4	25,00

UTENSILE PER RIMOZIONE MANIGLIA POGGIA MANO - GRUPPO VAG

Impugnatura in ABS



CODICE	L/mm	€/PZ
FG 185/RM	255	31,00

UTENSILE LEVA MOLLE A "C"

Ideale per la rimozione delle molle a C presenti sulle manovelle alzacetro



CODICE	€/PZ
FG 185/CR	10,50

UTENSILE RIMOZIONE CILINDRETTO CHIUSURA PORTIERE - GRUPPO VAG



CODICE	€/PZ
FG 189/PO1	21,00

UTENSILE RIMOZIONE CILINDRETTO CHIUSURA PORTIERE - GRUPPO VAG

NEW



CODICE	Per	€/PZ
FG 189/PO2	VW: Caddy 2016 >, Golf Sportsvan 2015 >, Passat 2015>, Polo 2017>, Tiguan 2016>, Touran 2016> Audi: Q2 2016>	40,00

UTENSILE RIMOZIONE SCHEGGE

Ideale per la pulizia del canale alzacristallo
Punta sferica per evitare danneggiamenti delle guide portiera



CODICE	L/mm	€/PZ
FG 182/RG10	255	19,00
FG 182/RG24	320	26,00

UTENSILE RIMOZIONE GUARNIZIONI VETRI

Impugnatura in ABS



CODICE	L/mm	€/PZ
FG 183/RV1	252	21,00

RASCHIETTO MANUALE A LAMA DRITTA

Fornito con una lama in dotazione Impugnatura in ABS dotata di foro per di appendimento
Dotato di protezione lama in ABS



CODICE	€/PZ
FG 183/RA1	26,00

KIT 10 LAME DI RICAMBIO PER RASCHIETTO FG 183/RA1



CODICE	€/PZ
FG 183RA/S10	12,50

COLTELLO MANUALE DOTATO DI CAVO E SISTEMA FERMA CAVO

Impugnatura e cavo rivestito in PVC
Fornito con una lama da 25mm già montata



CODICE	€/PZ
FG 183/CM	51,50

KIT 3 LAME DI RICAMBIO PER FG 183/CM



CODICE	L/mm	€/PZ
FG 183CM/S3	19, 25, 38mm	25,00

LAMA SINGOLA PER FG 183/CM

CODICE	L/mm	€/PZ
FG 183/CM19	19	8,50
FG 183/CM25	25	8,50
FG 183/CM38	38	8,50



COLTELLO MANUALE DOTATO DI LAMA INTERCAMBIABILE

Fornito con una lama in dotazione Impugnatura con rivestimento in PVC
Sistema di bloccaggio lama a vite



CODICE	L/mm	€/PZ
FG 183/CK250	250	22,00
FG 183/CK450	450	33,00
FG 183/CK600	600	41,50

KIT 10 LAME DI RICAMBIO PER COLTELLI FG 183/CK

CODICE	€/PZ
FG 183/CK-R	10,50

UTENSILE UNIVERSALE PER FISSAGGIO GUARNIZIONI

Dotato di 6 accessori
Sistema guida a rullo
Impugnatura in ABS



CODICE	€/PZ
FG 187/GR	29,00

LEVA BLOCCAFILO



CODICE	L1/mm	L2/mm	€/PZ
FG 187/GU	345	145	29,00

GUIDAFILO A T CON IMPUGNATURA IN ABS



CODICE	L/mm	€/PZ
FG 187/GU2	320	26,00

SET 2 IMPUGNATURE PER CAVO D'ACCIAIO



CODICE	€/PZ
FG 187/IM	41,50

BOBINA DI FILO IN ACCIAIO PER TAGLIO SIGILLANTE

Sezione triangolare



CODICE	L/mt	Sezione mm	€/PZ
FG 187/WT22.5	22,5	0.8	26,00

BOBINA DI FILO IN ACCIAIO PER TAGLIO SIGILLANTE

Sezione quadrata



CODICE	L/mt	Sezione mm	€/PZ
FG 187/W50	50	0.6	35,50

BOBINA DI FILO IN ACCIAIO PER TAGLIO SIGILLANTE

Sezione intrecciata



CODICE	L/mt	Sezione mm	€/PZ
FG 187/IW50	50	0.8	31,00

BOBINA DI FILO IN NYLON

Sezione intrecciata



CODICE	L/mt	Sezione mm	€/PZ
FG 187/NY	50	0.85	62,00

VENTOSA SINGOLA



CODICE	L/mm	Capacità kg	€/PZ
FG 187/K25	117	25	43,50

KIT 4 MINI-VENTOSE PER CRISTALLI AUTO



CODICE	L/mm	Capacità kg	€/PZ
FG 187/K10	117	10	24,00

VENTOSA DOPPIA



CODICE	L1/mm	L2/mm	Capacità kg	€/PZ
FG 187/K30	117	380	30	72,50

VENTOSA SINGOLA DOTATA DI IMPUGNATURA E SISTEMA POMPANTE



CODICE	Ø/mm	Capacità kg	€/PZ
FG 187/K40	178	40	196,00

VENTOSA SINGOLA MULTIFUNZIONE

Adatta per parabrezza autobus e mezzi pesanti
Fornita in box di ABS



CODICE	Ø/mm	Capacità kg	€/PZ
FG 187/K130	254	130	288,50

KIT 6 VENTOSE SINGOLE

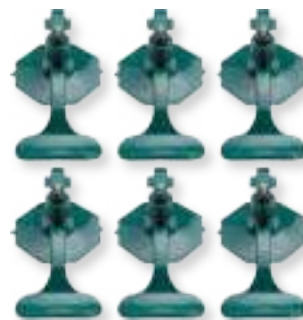

CODICE	Ø/mm	Capacità kg	€/PZ
FG 187K/S6	78	10	57,00

SET 7 UTENSILI PER CRISTALLI AUTO



CODICE	€/PZ
FG 187/S7	216,50

SET PER SMONTAGGIO PARABREZZA CON SISTEMA VENTOSE A CRICCHETTO

In valigetta di ABS

NEW



CODICE	Ø/mm	Capacità kg	€/PZ
FG 187/S2	150	50	700,00



SET PROTEZIONE CRUSCOTTO CON MANIGLIA

NEW



CODICE	€/PZ
FG 188P/S4	65,00

TIRABOLLI PNEUMATICO, CON DI 3 VENTOSE



CODICE	€/PZ
FG 187/PN	263,00

TIRABOLLI A BATTERE, CON DI 3 VENTOSE



CODICE	€/PZ
FG 187/TB	242,50

GIRAVITE ANGOLARE



CODICE	€/PZ
FG 186/AS	41,50

ESTRATTORE PER BRACCI TERGICRISTALLO



CODICE	Ø/mm	L/mm	€/PZ
FG 165/BC1	30-50	42	45,00

ESTRATTORE PER BRACCI TERGICRISTALLO



CODICE	Ø/mm	L/mm	€/PZ
FG 165/BC2	30-57	36	43,00

ESTRATTORE REGOLABILE PER BRACCI TERGICRISTALLO BMW

NEW



CODICE	Max Ø/mm	L/mm	€/PZ
FG 165/BC3	37,5	64	65,00

SET 6 ESTRATTORI PER BRACCI TERGICRISTALLO

1: VW, Porsche; 2: Ford, Seat, Mercedes; 3: BMW, VW; 4: Audi A3-A4-A5-A6; 5: VW, Opel, Honda; 6: Audi Q7

NEW



CODICE	€/PZ
FG 165BC/S6	230,00

UTENSILI PER SETTORE TRUCK



UNA GAMMA COMPLETA DI UTENSILI SPECIALI PER SETTORE TRUCK

IVECO

CHIAVE PER FILTRI OLIO

Applicazioni: VOLVO, IVECO, RENAULT, SCANIA

NEW



CODICE	Ø/mm interno	N. di lati	□	€/PZ
FG 500/F0135-15	135	15	1/2"	84,00

CHIAVE A BUSSOLA ESAGONALE PER DADI ASSALE

Applicazioni: Iveco - Cargo HA '98

NEW



CODICE	Ø/mm interno	Ø/mm esterno	□	H/mm	€/PZ
FG 500/A90	90	117	3/4"	68	148,00

CHIAVE A BUSSOLA ESAGONALE PER DADI MOZZO

Applicazioni: Iveco Euro Cargo, etc.



CODICE	Misura mm	Ø/mm esterno	●/mm	H/mm	€/PZ
FG 500/A98	98	122	36	117	190,50

CHIAVE A BUSSOLA PER DADI MOZZO

Applicazioni: Iveco Eurotech Cursor HA, etc.

NEW



CODICE	Misura mm	Ø/mm esterno	●/mm	H/mm	€/PZ
FG 500/B105	105	134	36	118	309,00
FG 500/B110	110	134	36	118	264,00
FG 500/B115	115	139	36	118	266,00



CHIAVE A BUSSOLA POLIGONALE PER MOZZI RUOTA

Applicazioni: Iveco Daily

NEW



CODICE	Misura mm	Ø/mm esterno	□	H/mm	€/PZ
FG 630/B65	65	88	1"	86,5	82,00

CHIAVE A BUSSOLA PER GIUNTI SFERICI

Applicazioni: Iveco Daily dal 2003 al 2011

NEW



CODICE	Ø/mm interno	Ø/mm esterno	□	H/mm	€/PZ
FG 500/IV32.3	32,3	41	1/2"	36	37,50

CHIAVE A BUSSOLA PER GIUNTI SFERICI



CODICE	Ø/mm interno	Ø/mm esterno	□	€/PZ
FG 500/IV72	72	85	3/4"	98,00

CHIAVE A BUSSOLA POLIGONALE PER MOZZI RUOTA

Applicazioni: vai modelli IVECO

NEW



CODICE	Misura mm	Ø/mm esterno	□	H/mm	€/PZ
FG 500/IV80	80	102	1"	60	118,50
FG 500/IV85	85	107,5	1"	60	122,50
FG 500/IV90	90	113	1"	60	125,00
FG 500/IV95	95	119	1"	60	142,00
FG 500/IV100	100	124	1"	60	144,50
FG 500/IV105	105	130	1"	60	159,00
FG 500/IV110	110	136	1"	60	172,50
FG 500/IV115	115	142	1"	60	185,50
FG 500/IV120	120	148	1"	60	196,50

CHIAVE PER PARAOLIO POSTERIORE ALBERO MOTORE

Applicazioni: Iveco Daily, Fuso

NEW



CODICE	€/PZ
FG 500/IV-PO	156,00

ATTREZZO PER ROTAZIONE ALBERO MOTORE

DOPPIO INGRANAGGIO

Codici motore: 8040.25.45,8060.25.45,8260,8210.42,8280,8460,190.38,190.42



CODICE	€/PZ
FG 197/IV1	240,00

ATTREZZO PER ROTAZIONE ALBERO MOTORE

DOPPIO INGRANAGGIO

Codici motore: 8360.46,F3A,F3B



CODICE	€/PZ
FG 197/IV2	242,00

FORD

CHIAVI PER DADI MOZZO POSTERIORE

Attacco esagonale maschio da 19 mm

Applicazioni: FORD TRANSIT DAL 2014 IN POI

NEW



CODICE	€/PZ
FG 510/FO2	71,00

SET PER BOCCOLA FORCELLA ANTERIORE

Applicazioni: Ford Transit Mik5 & Mik6 dal 2000 al 2013

NEW



CODICE	€/PZ
FG 510/WB	101,50

MERCEDES-BENZ

CHIAVE A BUSSOLA ESAGONALE PER FILTRI OLIO

Applicazioni: Mercedes-Benz Actros, Atego, Axor, Eonic

NEW



CODICE	Profilo	Apertura chiave mm	<input type="checkbox"/>	€/PZ
FG 526/MB46	esagonale / hexagonal	46	3/8"	47,00

CHIAVE PER GHIERE ASSALE POSTERIORE

Applicazioni: ghiera su autobus a pianale ribassato con assale a portale SF AV132 come Mercedes-Benz Citaro e altri veicoli con stesso assale

NEW



CODICE	Ø/mm interno	Ø/mm esterno	H/mm	Ø/mm perno	L/mm perno	€/PZ
FG 520/GA1	122,7	138,8	295	123,7	6	257,00

CHIAVE PER GHIERE ASSALE POSTERIORE ZF

Applicazioni: Mercedes Benz Citaro, ZF AV 133 bus, ZF AV 133 rear bus

NEW



CODICE	Ø/mm interno	Ø/mm esterno	H/mm	Ø/mm perno	L/mm perno	€/PZ
FG 520/GA2	122,7	138,8	308	124	6	235,50

CHIAVE PER GHIERE ASSALE ZF 132

Applicazioni: ghiera su Mercedes-benz Citaro, EvoBus con assale posteriore ZF 132

NEW



CODICE	Ø/mm interno	Ø/mm esterno	H/mm	Ø/mm perno	L/mm perno	€/PZ
FG 520/GA3	70	84	60,5	72	10,6	70,50

CHIAVE A 6 DENTI PER GHIERE ASSALE

Applicazioni: MERCEDES-BENZ SPRINTER HA, ecc.

NEW



CODICE	€/PZ
FG 520/GA4	65,50

CHIAVE A 6 DENTI PER GHIERE ASSALE POSTERIORE

Applicazioni: MERCEDES-BENZ e MAN 10/13T, Ipoide e rimorchio NR7/4 - Omnibus 0305 G + 0405 G, etc.

NEW



CODICE	Ø/mm interno	Ø/mm esterno	H/mm	Ø/mm perno	L/mm perno	€/PZ
FG 520/GA5	95	115	110	101	11,5	208,50

CHIAVE A 6 DENTI PER GHIERE MOZZI RUOTA

Applicazioni: MAN, Mercedes Benz

NEW



CODICE	N. denti	Dente/mm	Ø/mm interno (da dente a dente)	Ø/mm interno (da lato a lato)	€/PZ
FG 520/GA6	6	11,5	101,7	110,7	213,50



CHIAVE PER GHIERE 105-125MM

Applicazioni: Mercedes-Benz Actros, HL/HL8 (HYPOID), ecc.

NEW



CODICE	Ø/mm interno	Ø/mm esterno	H/mm	Ø/mm perno	L/mm perno	€/PZ
FG 522/C105	105	125	180	116,5	9,8	216,50

CHIAVE A BUSSOLA POLIGONALE PER DADI ASSALI

Applicazioni: dado perno rimorchi Mercedes-Benz

NEW



CODICE	Ø/mm interno	Ø/mm esterno	H/mm	●/mm	€/PZ
FG 522/B95	95	126	157	36	277,00

CHIAVE A 12 DENTI PER ASSALI POSTERIORI

NEW



CODICE	Ø/mm interno	Denti	□	€/PZ
FG 522/C101.5	101,5	12	3/4"	216,50

CHIAVE A 6 DENTI PER ASSALI POSTERIORI

NEW



CODICE	Ø/mm interno	Ø/mm esterno	Denti	□	€/PZ
FG 522/C91.5	91,5	99,5	6	3/4"	202,50

CHIAVE PER ASSALI POSTERIORI

Applicazioni: Mercedes-Benz Ateco, Vitaro 814, MAN, ecc.

NEW



CODICE	Ø/mm interno	Ø/mm esterno	Ø/mm tubo di posizionamento	H/mm	Ø/mm perno	L/mm perno	€/PZ
FG 522/C80	80	95	49	175	87	10	171,50

CHIAVE A BUSSOLA PER DADI ASSALI



CODICE	Ø/mm interno	Ø/mm esterno	H/mm	●/mm	€/PZ
FG 522/A95	95	118	157	36	218,50

TUBO DI PROLUNGA PER ASSALE POSTERIORE DESTRO

Applicazioni: Filettatura destra = assale posteriore HL2 ad es. MAN serie L

NEW



CODICE	Filettatura destra	Ø/mm interno	Ø/mm esterno	L/mm	●/mm	€/PZ
FG 522/TU-DX	M75X1.5L	60	78	185	41	190,50

TUBO DI PROLUNGA PER ASSALE POSTERIORE SINISTRO

Applicazioni: Filettatura sinistra = Mercedes-Benz Ateco / Vario

NEW



CODICE	Filettatura sinistra	Ø/mm interno	Ø/mm esterno	L/mm	●/mm	€/PZ
FG 522/TU-SX	M75X1.5L	60	78	185	41	204,50

CHIAVE A BUSSOLA PER RIMOZIONE DADI DIFFERENZIALE POSTERIORE

Applicazioni: MAN , Mercedes Benz Truck

NEW



CODICE	N. denti	Dente/mm	Ø/mm interno (da dente a dente)	Ø/mm interno (da lato a lato)	€/PZ
FG 522/GA7	6	8,7	113	126	270,00

CHIAVE A BUSSOLA ESAGONALE PER DADI MOZZI ANTERIORI

Applicazioni: MERCEDES-BENZ ACTROS

NEW



CODICE	Punte	Ø/mm	□	€/PZ
FG 522/A89	6	89	3/4"	153,00

CHIAVE A BUSSOLA PER DADI AUTOBLOCCANTI ASSALE POSTERIORE

Applicazioni: DAF, MAN, MERCEDES-BENZ, KASSBOHRER E SETRA

NEW



CODICE	Apertura chiave mm	H/mm	□	€/PZ
FG 524/MB-R56	56	53	3/4"	100,50

CHIAVE A BUSSOLA PER DADI AUTOBLOCCANTI ASSALE POSTERIORE

Applicazioni: DAF, MAN, MERCEDES-BENZ, KASSBOHRER E SETRA



CODICE	Apertura chiave mm	H/mm	□	€/PZ
FG 524/MB-R60	60	53	3/4"	104,00

CHIAVE A BUSSOLA PER DADI AUTOBLOCCANTI ASSALE POSTERIORE

Applicazioni: SETRA e NEOPLAN

NEW



CODICE	Apertura chiave mm	H/mm	□	€/PZ
FG 524/MB-R62	54x68	53	1/2"	103,50

CHIAVE A BUSSOLA POLIGONALE PER ASSALE PRINCIPALE DEL DIFFERENZIALE

Applicazioni: BENZ 2544

NEW



CODICE	Punte	Ø/mm interno	Ø/mm esterno	H/mm	□	€/PZ
FG 522/B68	12	68	88	58,5	3/4"	103,50

UTENSILE PER INSERIMENTO PARAOLIO ASSALE POSTERIORE

Spessore anelli: 7.5 mm, 17.5 mm, 20 mm, 36 mm
Adatto per paraoli doppi montati su 746.21, 748.59, cc.
Applicazioni: Mercedes-Benz Actrox, Atego

NEW



CODICE	€/PZ
FG 527/PO-MB	831,00

CHIAVE A BUSSOLA PER RIMOZIONE VALVOLA INIEZIONE

Applicazioni: MAN 422/403, MERCEDES-BENZ, SCANIA

NEW



CODICE	Ø/mm interno	Ø/mm esterno	H/mm	€/PZ
FG 528/RV1	22	28	72	23,00



ATTREZZO PER ROTAZIONE ALBERO MOTORE

Doppio ingranaggio

Modelli: Mercedes-Benz 6, 8, 10 cil.; MAN 12 cil.

Codici motore: 401, 404, 407, 409, 421, 424, 444, 427, 447



CODICE	Attacco	€/PZ
FG 197/MB1	1/2"	90,00

ATTREZZO PER ROTAZIONE ALBERO MOTORE

Triplo ingranaggio

Modelli: Mercedes-Benz Actros e Atego; MAN 5, 6, 8 cilindrata



CODICE	Attacco	€/PZ
FG 197/MB2	1/2"	120,00

MAN

CHIAVE PER FILTRO OLIO

Applicazioni: MAN 403, 463



CODICE	Ø/mm interno	N. di lati	□	€/PZ
FG 530/FO94	94	14	1/2"	70,50

CHIAVE A BUSSOLA SENZA CANOTTO DI GUIDA PER GHIERE ASSALI

Applicazioni: TGA (V982L-01)



CODICE	Ø/mm interno	Ø/mm esterno	H/mm	€/PZ
FG 531/GA1	133	147,5	110	248,50

CHIAVE A BUSSOLA CON CANOTTO DI GUIDA PER GHIERE ASSALI

Applicazioni: MAN TGA 460, V9-82L-01



CODICE	Ø/mm interno	Ø/mm esterno	H/mm	€/PZ
FG 531/GA2	133	147,5	155	330,00

CHIAVE DI SERRAGGIO PER GHIERE ASSALI ANTERIORI

Applicazioni: MAN e Mercedes-Benz.



CODICE	Ø/mm interno	Ø/mm esterno	H/mm	€/PZ
FG 531/GA3	100,8	110	80,5	150,00

CHIAVE A 6 DENTI PER GHIERE ASSALI

Applicazioni: MAN 403, 463



CODICE	Ø/mm interno	Ø/mm esterno	H/mm	L/mm dente mm	H/mm dente	□	€/PZ
FG 531/GA4	76,5	87	95	13	11	3/4"	119,00

CHIAVE A 6 DENTI PER DADI ASSALE RUOTA ANTERIORE

Applicazioni: MAN TGA



CODICE	Ø/mm interno	Ø/mm esterno	H/mm	Attacco	€/PZ
FG 531/GA5	88,5	97,5	80,5	3/4"	134,50

NEW

NEW

NEW

NEW

NEW

NEW

CHIAVE A 6 DENTI PER DADI ASSALE ANTERIORE

Applicazioni: MAN VW2, VW4, VW6.1-6.8

NEW



CODICE	Ø/mm esterno	H/mm	□	€/PZ
FG 531/GA6	84	100	1"	115,50

TUBO DI PROLUNGA PER ASSALE POSTERIORE

Applicazioni: Assale posteriore MAN TGA ad esempio HY 1350

NEW



CODICE	Filettatura	Ø/mm interno	Ø/mm esterno	L/mm	€/PZ
FG 536/PR-100	M100X1,5	96	104,6	360	217,50

CHIAVE PER GHIERE TRASMISSIONE

NEW



CODICE	Ø/mm interno	Ø/mm esterno	H/mm	□	€/PZ
FG 534/GA1	53,5	71,8	76	3/4"	92,50

ESTRATTORE PER MOZZO RUOTA ANTERIORE

NEW



CODICE	Ø/mm interno	Ø/mm esterno	€/PZ
FG 532/MA-1	50,1	153,7	343,00

ESTRATTORE PER MOZZO RUOTA ANTERIORE

NEW



CODICE	Ø/mm interno	Ø/mm esterno	H/mm	€/PZ
FG 532/MA-2	100,2	115x1,5	93	250,00

ESTRATTORE PER MOZZO RUOTA ANTERIORE

Applicazioni: diametri fori fino a 166 mm

NEW



CODICE	Ø/mm interno	H/mm	€/PZ
FG 532/MA-3	87,1	118,2	363,00

ATTREZZO PER ROTAZIONE ALBERO MOTORE

Codici motore: D20..., D25..., D26..., D28...



CODICE	Attacco	€/PZ
FG 197/MA1	1/2"	95,00

VOLVO

CHIAVE PER FILTRO OLIO

Applicazioni:
S60 XC / S60 V60 (2011-) / S80 (2007-) / S90 V90 (2017-) / V40 (2013-) / V40 XC / V60 XC / V70 (2008-) / V70, XC70 (2008-) / XC60 / XC70 (2008-) / XC90 (2016-)

NEW



CODICE	Ø/mm interno	N. lati	€/PZ
FG 540/F086	86	16	77,50



CHIAVE PER FILTRO OLIO

NEW



CODICE	Ø/mm interno	N. lati	□	€/PZ
FG 540/FO107-15	107	15	1/2"	63,00

UTENSILE PER INSTALLAZIONE E RIMOZIONE GANASCE DEI FRENI

NEW

Applicazioni: freni a tamburo Volvo con camma a Z, ad esempio N7 - N10 - N12 - F7 - F12 - F16 - FH12 - FH16 - FL7 - FL10 - ERF serie E/EC



CODICE	€/PZ
FG 543/GF	194,00

CHIAVE PER FILTRO OLIO

Applicazioni: motori UD GH11, GH13

NEW



CODICE	Ø/mm interno	N. lati	□	€/PZ
FG 540/FO107-8	107	8	1/2"	44,00

CHIAVE PER DADI TUBO OLIO TRASMISSIONE

Applicazioni: Volvo - serie FM

NEW



CODICE	Profilo	Misura profilo mm	Attacco	€/PZ
FG 544/TR74	esagonale / hexagonal	74	ottagonale 1/2" / 1/2" octagonal	68,50

CHIAVE A BUSSOLA PER PERNI BALESTRE

Profilo ovale

NEW



CODICE	Ø/mm interno	Ø/mm esterno	H/mm	□	€/PZ
FG 542/VO28.5	28,5	62	60	3/4"	75,50

UTENSILE PER ASSEMBLAGGIO ANELLO TENUTA ALBERO DI USCITA DELLA TRASMISSIONE

NEW



CODICE	€/PZ
FG 544/TA	195,50

CHIAVE A BUSSOLA PER PERNI BALESTRE

Application: VOLVO ad esempio FL6 / F10 / F12



CODICE	Ø/mm interno	Ø/mm esterno	H/mm	Ø/mm perni	€/PZ
FG 542/VO27	27	37@315	8,7	27	32,50

CHIAVE A BUSSOLA ESAGONALE PER DADI ASSALE

Applicazioni: VOLVO / RENAULT /IVECO/FIAT

NEW



CODICE	Profilo	Misura profilo mm	H/mm	Attacco	€/PZ
FG 545/L80	esagonale / hexagonal	80	175,5	1"	213,00
FG 545/L95	esagonale / hexagonal	95	175,5	1"	239,00

CHIAVE A BUSSOLA ESAGONALE PER DADI ASSALE

NEW



CODICE	Ø/mm interno	Ø/mm esterno	H/mm	□	€/PZ
FG 545/A80	80	100	55	3/4"	113,50
FG 545/A95	95	125	68	1"	172,50
FG 545/A105	105	135	68	1"	199,00

CHIAVE A BUSSOLA OTTAGONALE PER DADI ASSALE



CODICE	Ø/mm interno	Ø/mm esterno	H/mm	□	€/PZ
FG 545/A115	115	137	81	3/4"	210,50

CHIAVE A BUSSOLA PER CUSCINETTO VENTOLA

NEW



CODICE	Ø/mm interno	Ø/mm esterno	H/mm	□	€/PZ
FG 546/GA1	53,8	72,8	46	3/4"	87,50

ATTREZZO PER INSERIMENTO CUSCINETTO ALBERO PRINCIPALE DEL DIFFERENZIALE

Applicazioni: VOLVO FH / FM

NEW



CODICE	€/PZ
FG 547/VO-AL1	207,00

ATTREZZO PER INSERIMENTO PARAOLIO ALBERO MOTORE POSTERIORE

Applicazioni: Volvo FM12 (420,430,440)

NEW



CODICE	€/PZ
FG 548/PO-V	920,00

ATTREZZO PER ROTAZIONE ALBERO MOTORE

Codici motore: D9A,D12,D16C



CODICE	€/PZ
FG 197/VO1	95,00

ATTREZZO PER ROTAZIONE ALBERO MOTORE

Codici motore: MP8,MP10,(FH, D13A520)



CODICE	Ø/mm	€/PZ
FG 197/VO2	1/2", 46	77,00

ATTREZZO PER IL VOLANO

Applicazioni: Renault Magnum

NEW



CODICE	€/PZ
FG 197/VO3	62,00



ATTREZZO DI ROTAZIONE DEL VOLANO

Codici motore: D7A; D7B; D7C



NEW

CHIAVE A BUSSOLA OTTAGONALE PER COPRIMOZZI E DADI MOZZO PER ASSALE ANTERIORE

NEW



CODICE

€/PZ

FG 197/V04

73,00

CODICE	Ø/mm interno	Ø/mm esterno	H/mm	□	€/PZ
FG 554/A83	83	103	74	1"	139,50

SCANIA

CHIAVE A BUSSOLA PER ALBERO PRINCIPALE ANTERIORE FRIZIONE CAMBIO

NEW



CHIAVE A BUSSOLA OTTAGONALE PER COPRIMOZZI E DADI MOZZO PER ASSALE POSTERIORE



CODICE	Ø/mm interno	Ø/mm esterno	H/mm	□	€/PZ
FG 550/GA1	72,5	92	76	3/4"	110,00

CODICE	Ø/mm interno	Ø/mm esterno	H/mm	□	€/PZ
FG 554/A95	95	118	84	3/4"	153,00

CHIAVE A BUSSOLA PER RIMOZIONE RONDELLA ELASTICA AMMORTIZZATORE RUOTA ANTERIORE



CHIAVE A BUSSOLA OTTAGONALE PER ASSALE



CODICE	Ø/mm interno	Ø/mm esterno	H/mm	□	€/PZ
FG 551/SC28	28,5	54	50	3/4"	48,50
FG 551/SC34	34,5	74	50	3/4"	69,00
FG 552/SC34	34,5	63	50	3/4"	56,50

CODICE	Ø/mm interno	Ø/mm esterno	H/mm	□	€/PZ
FG 554/A100	100	123	84	3/4"	195,00

CHIAVE A BUSSOLA OTTAGONALE PER COPRIMOZZI E DADI MOZZO PER ASSALE ANTERIORE



CHIAVE A BUSSOLA A 8 DENTI PER DADO MOZZO SCANALATO

Applicazioni: dadi scanalati degli assali Scania 420

NEW



CODICE	Ø/mm interno	Ø/mm esterno	H/mm	□/mm	€/PZ
FG 554/A80	80,5	100,2	102,2	41	161,00

CODICE	Ø/mm interno	Ø/mm esterno	N. denti esterni	Dente mm	H/mm	□	€/PZ
FG 554/A103	103	119	8	9,5	100	3/4"	204,50

CHIAVE A BUSSOLA PER LE GHIERE TRASMISSIONE

Applicazioni: SCANIA 310/320



NEW

CODICE	Ø/mm interno	Ø/mm esterno	H/mm	□	€/PZ
FG 555/GA1	63/64	81,7	65	3/4"	86,50

CHIAVE A BUSSOLA PER LE GHIERE TRASMISSIONE

Applicazioni: Bus Scania a 8 marce



NEW

CODICE	Ø/mm interno	Ø/mm esterno	H/mm	□	€/PZ
FG 555/GA2	59	78	76	3/4"	93,50

CHIAVE A BUSSOLA PER DADO ASSALE PRINCIPALE ANTERIORE FRIZIONE (TRASMISSIONE)

Applicazioni: cambi automatici a 10 marce Scania



NEW

CODICE	Ø/mm interno	Ø/mm esterno	H/mm	□	€/PZ
FG 555/GA65	65,3	78,7	80	3/4"	69,00

UTENSILE PER INSERIMENTO PARAOLIO POSTERIORE ALBERO MOTORE

Applicazioni: SCANIA 310/320



NEW

CODICE	€/PZ
FG 556/PO-SC1	135,00

UTENSILE PER INSERIMENTO PARAOLIO POSTERIORE TRASMISSIONE

Applicazioni: alberi di trasmissione flangiati SCANIA sulla trasmissione e sugli assali posteriori



NEW

CODICE	€/PZ
FG 556/PO-SC2	90,00

UTENSILE PER INSERIMENTO PARAOLIO POSTERIORE TRASMISSIONE

Applicazioni: truck SCANIA (114) 340/360/380



NEW

CODICE	€/PZ
FG 556/PO-SC3	242,50

UTENSILE PER INSERIMENTO PARAOLIO POSTERIORE TRASMISSIONE

Adatto per paraolio: Ø140 x Ø160 x 12L

Applicazioni: SCANIA (114) 340/360/380, truck della serie P.R



NEW

CODICE	€/PZ
FG 556/PO-SC4	262,00

UTENSILE COMPRESIONE MOLLE VALVOLE

Applicazioni: truck SCANIA 340/ 360/ 380

Vite: M10 x P1.5, 25L



NEW

CODICE	€/PZ
FG 557/SC-V	148,00



UTENSILE PER RIMOZIONE E INSTALLAZIONE BOCCOLE INIETTORI

Applicazioni: motori SCANIA 113 114

NEW



CODICE	€/PZ
FG 557/SC-RI	519,50

ATTREZZO PER ROTAZIONE ALBERO MOTORE

codici motore: SCANIA dal 1996 in poi



CODICE	Attacco	€/PZ
FG 197/SC1	1/2"	66,00

DAF

CHIAVE PER FILTRO OLIO

Applicazioni: DAF(LF) 12/17 Tonnellate (EURO4/5)

NEW



CODICE	Ø/mm interno	Ø/mm esterno	H/mm	€/PZ
FG 560/F092	92	10	1/2"	62,00

UTENSILE PER INSERIMENTO PARAOLIO POSTERIORE ALBERO MOTORE

Adatto per paraolio: Ø166 x Ø191 x 16L

Applicazioni: DAF CF85 410/460. Euro 4 e Euro 5

NEW



CODICE	€/PZ
FG 566/PO-D1	322,50

UTENSILE PER INSERIMENTO PARAOLIO POSTERIORE ALBERO MOTORE

Applicazioni: DAF 17 TONNELLATE (LF55); DAF 17 TONNELLATE (CF65)

NEW



CODICE	€/PZ
FG 566/PO-D2	200,00

UTENSILE PER INSERIMENTO PARAOLIO ANTERIORE ALBERO MOTORE

Applicazioni: truck DAF (CF) 35-43 tonnellate (Euro 4/5)

NEW



CODICE	€/PZ
FG 566/PO-D3	360,00

ATTREZZO PER ROTAZIONE ALBERO MOTORE

Codici motore: 65CF,75CF,85CF,95XF,CF75,CF85,F65,F75,F85,F95,XF95F95,XF95



CODICE	Ø/mm	€/PZ
FG 197/DA1	24	88,00

ATTREZZO PER ROTAZIONE ALBERO MOTORE

Codici motore: XF105 Euro5



CODICE	Attacco	€/PZ
FG 197/DA2	1/2"	68,00

SAF

CHIAVE A BUSSOLA PER ASSALE RIMORCHI

NEW



CODICE	Ø/mm interno	Ø/mm esterno	H/mm	●/mm	€/PZ
FG 570/SA-85	85	117	82	36	136,50

CHIAVE A BUSSOLA PER ASSALE RIMORCHI

NEW



CODICE	Ø/mm interno	H/mm	●/mm	€/PZ
FG 570/SA-140	140	145	32/46	187,00

BPW

CHIAVE PER DADI ASSALI E PER COPERTURA DADI RUOTA SUGLI ASSALI

applicazioni: BPW da 6,5 a 9 tonnellate



CODICE	Apertura chiave mm	Ø/mm esterno	H/mm	□	€/PZ
FG 580/BP-65	64,5	84	51	3/4"	86,50
FG 580/BP-80	80	107,8	65	3/4"	139,50

CHIAVE PER DADI ASSALI E PER COPERTURA DADI RUOTA SUGLI ASSALI

applicazioni: BPW da 13 a 14 tonnellate

NEW



CODICE	Apertura chiave mm	Ø/mm esterno	H/mm	□	€/PZ
FG 580/BP-85	85,05	116,9	70	3/4"	129,00

CHIAVE A BUSSOLA ESAGONALE PER DADI ASSALI E PER COPERTURA DADI RUOTA SUGLI ASSALI

Applicazioni: BPW (dadi a corona) - assali da 16 tonnellate

NEW



CODICE	Impronta	Ø/mm interno	Ø/mm esterno	H/mm	□	€/PZ
FG 582/BP-85	esagonale / hexagonal	85,3	110	84	3/4"	145,00

CHIAVE A BUSSOLA PER COPERTURE ASSALE POSTERIORE

Applicazioni: BPW 6.5-9 tonnellate

NEW



CODICE	Impronta	Ø/mm interno	Ø/mm esterno	H/mm	□	€/PZ
FG 582/BP-95	ovale / oval	95	114,7	70	3/4"	160,50

CHIAVE A BUSSOLA OTTAGONALE PER DADO COPRIMOZZO POSTERIORE

Applicazioni: BPW 12 tonnellate



CODICE	Ø/mm interno	Ø/mm esterno	H/mm	●/mm	€/PZ
FG 582/BP-109	109,1	128,9	94,3	41	197,50

CHIAVE A BUSSOLA ESAGONALE PER COPRIMOZZO

NEW



CODICE	Impronta	Ø/mm interno	Ø/mm esterno	H/mm	□	€/PZ
FG 582/BP-100	esagonale / hexagonal	100	130	68	1"	197,50



CHIAVE A BUSSOLA OTTAGONALE PER COPERTURE ASSALE POSTERIORE

NEW



CODICE	Impronta	Ø/mm interno	Ø/mm esterno	H/mm	□	€/PZ
FG 582/BP-110	ottagonale / 8-point	110	133	81	3/4"	179,50

CHIAVE A BUSSOLA PER DADO COPRIMOZZO POSTERIORE

Applicazioni: BPW 12 tonnellate

NEW



CODICE	Ø/mm interno	Ø/mm esterno	H/mm	●/mm	€/PZ
FG 582/BP-111	111	131,9	84,1	41	194,50

CHIAVE A BUSSOLA PER DADO COPRIMOZZO POSTERIORE

Applicazioni: BPW 16 tonnellate



CODICE	Ø/mm interno	Ø/mm esterno	H/mm	●/mm	€/PZ
FG 582/BP-120	120,1	143	94,2	41	214,50

ESTRATTORE PER REGOLATORE DI FRENATA PER ASSALI

NEW



CODICE	a/mm	b/mm	c/mm	d/mm	●/mm	€/PZ
FG 584/BP-ES1	66	158	93,5	127	32	193,00

ESTRATTORE PER MOZZI RUOTA

Filettatura esterna: M125 x 2,0

Applicazioni: BPW da 12t

NEW



CODICE	Ø/mm interno	Ø/mm esterno	H/mm	●/mm	€/PZ
FG 585/BP-MR125	93,1	M125X2,0	99,4	42,8	325,50

ESTRATTORE PER MOZZI RUOTA

Filettatura: M155x3.0

Applicazioni: truck da 16t

NEW



CODICE	Ø/mm interno	Ø/mm esterno	H/mm	●/mm	€/PZ
FG 585/BP-MR155	98	M155X3,0	98,5	49	325,50

ESTRATTORE PER MOZZI RUOTA

Filettatura interna: M135x2.0

Applicazioni: BPW ECO da 10t a 12t

NEW



CODICE	Ø/mm interno	Ø/mm esterno	H/mm	●/mm	€/PZ
FG 585/BP-MR135	M135X2,0	150	120,3	43	343,00

ESTRATTORE PER MOZZI RUOTA

Filettatura: M136X2,5

Applicazioni: BPW ECO Plus 8-12 t, BPW ECO 10 t

NEW



CODICE	Ø/mm interno	Ø/mm esterno	H/mm	●/mm	€/PZ
FG 585/BP-MR136	M136x2,5	150	120,3	43	343,00

UNIVERSALI

SET UTENSILI PER CENTRAGGIO FRIZIONI

Coni di centraggio:

- Ø 36-45m

- Ø 42-52m



CODICE	€/PZ
FG 180/S6	210,00

ESTRATTORE GIUNTI CARDANICI PESANTI

Applicazioni: tutte le trasmissioni Spicer 1610, 1710, 1760, 1810, 1880; Spicer SPL 140, 170 e 250 "Life Series"; Meritor (Rockwell) 16N, 17N, 18N, 1710; Meritor RPL 20 e 25 Serie "Permalube"

NEW



CODICE	€/PZ
FG 590/GO	191,50

ESTRATTORE PER SNODI SFERICI



CODICE	A/mm	B/mm	H/mm	Filettatura mm	€/PZ
FG 197/BP	60	39	155	M24x3.0	330,00

CHIAVE A PERCUSSIONE TORX E XZN PINZE FRENO

NEW



CODICE	Attacco quadro	Impronta	Dimensione	Applicazione	€/PZ
FG 592/E18	3/4"	torx	E18	Man TGL/TGM	44,00
FG 592/E20	3/4"	torx	E20	Man TGL/TGM	46,50
FG 592/E24	3/4"	torx	E24	Man TGA/TGS/TGX	46,50
FG 592/M24	3/4"	poligonale/12-pt	24 mm	SAF	46,50
FG 592/M26	3/4"	poligonale/12-pt	26 mm	DAF XF/XF95/XF105/XF106	46,50

CHIAVE A BUSSOLA PER PINZE FRENO

Applicazioni: Volvo Peterbilt, DAF Foden MAN Mercedes Scania BOVA più BPW SAF Trailer

NEW



CODICE	Profilo	H/mm	□	€/PZ
FG 595/B11	11 punte/11-pt	26	3/8"	10,50

CHIAVE PER FILTRI ESSICCATORI

FG 197/F1: Ø 120-140mm

FG 197/F2: - Ø 125-145mm



CODICE	Ø/mm	€/PZ
FG 197/F1	120-140	50,00
FG 197/F2	125-145	28,00



FASANO
ITALY

12

MANUTENZIONE GENERALE



PISTOLA A LEVA PER GRASSO

Utilizzabile con grasso in cartuccia e grasso sfuso
Dotata di cannuccia rigida e tubo flessibile



CODICE	Capacità cc	L/mm tubo	Ø/mm	€/PZ
FG 490/C500	500	320	53	52,00
FG 490/C800	800	500	53	65,00
FG 490/C1000	1.000	500	53	65,00

TESTINA DI RICAMBIO A 4 GRIFFE



CODICE	€/PZ
FG 490/TE	3,00

OLIATORE IN PLASTICA A CANNUCCIA FLESSIBILE

Lunghezza cannuccia 190 mm



CODICE	Capacità cc	L/mm tubo	€/PZ
FG 496/FP1	200	190	10,50
FG 496/FP2	350	190	11,00
FG 496/FP3	500	190	11,50

OLIATORE IN PLASTICA A CANNUCCIA RIGIDA



CODICE	Capacità cc	L/mm tubo	€/PZ
FG 495/FA1	200	145	10,00
FG 495/FA2	350	145	10,50
FG 495/FA3	500	145	11,50

PISTOLA PER GRASSO A PRESSIONE

Utilizzabile con grasso in cartuccia e grasso sfuso
Dotata di testina a punta e testina a 4 griffe



CODICE	L/mm	€/PZ
FG 490/PT	210	15,00

SIRINGA PER OLIO



CODICE	Capacità cc	L/mm cannuccia	€/PZ
FG 491	500	260	21,50

OLIATORE A PRESSIONE CON CANNUCCIA RIENTRANTE IN OTTONE



CODICE	Capacità cc	L/mm cannuccia	€/PZ
FG 497/OP1	30	10-165	6,30
FG 497/OP2	80	110-175	7,40
FG 497/OP3	150	150-240	7,60

OLIATORE A PRESSIONE CON CANNUCCIA IN POLIETILENE



CODICE	Capacità cc	L/mm cannuccia	€/PZ
FG 497/SP1	125	150	8,20
FG 497/SP2	250	180	9,00

OLIATORE A STILO



CODICE	Capacità cc	L/mm	€/PZ
FG 497	5	140	11,60

PISTOLA PER SIGILLANTE CON TUBO IN ALLUMINIO

Dotata di sistema anti-goccia



CODICE	Capacità cc	L/mm	€/PZ
FG 493/N	300	240	38,50

PISTOLA PER SIGILLANTE CON TUBO IN ACCIAIO

Corpo principale e meccanismo interno interamente in acciaio



CODICE	Capacità cc	L/mm	L/mm tubo	€/PZ
FG 493/AL	300	440	240	45,00
FG 493/AL2	400	480	280	46,00
FG 493/AL3	600	580	380	55,00

SET 4 SPATOLE IN ACCIAIO INOX



CODICE	€/PZ
FG 47/S4	21,50

PISTOLA PER COLLA A CALDO

Potenza nominale di riscaldamento 80W

Temperatura di esercizio: 193°C

Tempo di riscaldamento: 3/5 minuti

Fornita in box di ABS con 12 stick colla inclusi



CE

CODICE	L/mm stick colla	Ø stick colla	€/PZ
FG 494/S12	200	11,5	55,00

PISTOLA PER COLLA A CALDO

Potenza nominale di riscaldamento 180W

Temperatura di esercizio 193°C

Tempo di riscaldamento 3/5 minuti

Dotata di piede d'appoggio per evitare che la punta riscaldata tocchi la superficie del piano di lavoro

Fornita con 1 beccuccio di ricambio



CE

CODICE	L/mm stick colla	Ø stick colla	€/PZ
FG 494/A180	100/250/350	11/11,5	175,00



RASCHIETTO A BATTERE CON LAMA DRITTA IN ACCIAIO INOX

Lama in acciaio Inox
Impugnatura dotata di testa in acciaio per utilizzo a battere
Impugnatura in polipropilene con rivestimento in gomma anti-scivolo
Dotato di foro per appendimento



CODICE	€/PZ
FG 47/P1	18,50

RASCHIETTO A BATTERE CON LAMA PIEGATA IN ACCIAIO INOX

Lama in acciaio Inox
Impugnatura dotata di testa in acciaio per utilizzo a battere
Impugnatura in polipropilene con rivestimento in gomma anti-scivolo
Dotato di foro per appendimento



CODICE	€/PZ
FG 47/P2	18,50

RASCHIETTO A BATTERE CON LAMA PIATTA IN ACCIAIO INOX

Lama in acciaio Inox
Impugnatura dotata di testa in acciaio per utilizzo a battere
Impugnatura in polipropilene con rivestimento in gomma anti-scivolo
Dotato di foro per appendimento



CODICE	€/PZ
FG 47/P3	18,50

SET 3 RASCHIETTI A BATTERE CON LAMA IN ACCIAIO INOX

Lama in acciaio Inox
Impugnatura dotata di testa in acciaio per utilizzo a battere
Impugnatura in polipropilene con rivestimento in gomma anti-scivolo
Dotato di foro per appendimento



CODICE	€/PZ
FG 47/S3	58,00

MORSA PARALLELA DA BANCO IN ACCIAIO FORGIATA

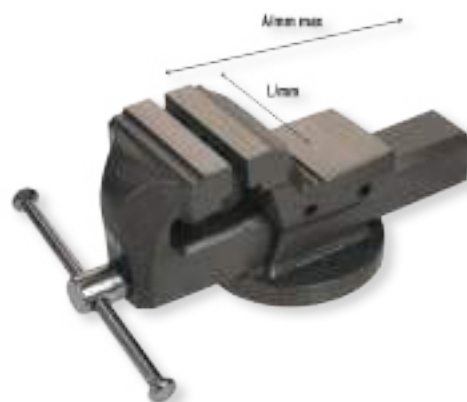

CODICE	L/mm	A/mm	€/PZ
FG 121/B100	100	125	275,00
FG 121/B125	125	150	380,00
FG 121/B150	150	200	480,00
FG 121/B175	175	220	700,00

LEVA CON LAMA CURVA PIATTA ED ESTREMITÀ A BATTERE

Impugnatura in polipropilene rigido dotata di testa in acciaio per utilizzo a battere



CODICE	L/mm	€/PZ
FG 125/A1	300	15,00
FG 125/A2	450	21,00
FG 125/A3	600	25,50

SET



SET 3 LEVE

CODICE	€/PZ
FG 125/S3	68,00

SPAZZOLA CON FILI IN OTTONE



CODICE	L/mm	€/PZ
FG 79/SP	180	4,00

SPAZZOLA CON FILI IN OTTONE



CODICE	L/mm	€/PZ
FG 79/SP2	225	9,50

SPAZZOLA CON FILI IN ACCIAIO ONDULATO OTTONATO



CODICE	L/mm	€/PZ
FG 79/SP4	270	5,30

SPAZZOLA CON FILI RIGIDI IN ACCIAIO



CODICE	L/mm	€/PZ
FG 79/SP3	275	5,50

LEVA DA CARPENTIERE



CODICE	L/mm	€/PZ
FG 125/L500	500	21,00
FG 125/L700	700	27,00

RIVETTATRICE MANUALE CON 4 TESTINE INTERCAMBIABILI

Adatta per:

Rivetti in alluminio: 2.4 (3/32"), 3.0/3.2 (1/8"), 4.0 (5/32"), 4.8/5.0 (3/16"), 5.0
 Rivetti in acciaio: 2.4 (3/32"), 3.0/3.2 (1/8"), 4.0 (5/32"), 4.8/5.0 (3/16"), 5.0
 Rivetti in INOX: 2.4 (3/32"), 3.0/3.2 (1/8"), 4.0 (5/32"), 4.8/5.0 (3/16"), 5.0



CODICE	€/PZ
FG 260	80,00

RIVETTATRICE DI POTENZA CON 5 TESTINE INTERCAMBIABILI

Adatta per:

Rivetti in alluminio: 2.4 (3/32"), 3.0/3.2 (1/8"), 4.0 (5/32"), 4.8/5.0 (3/16"), 6.4
 Rivetti in acciaio: 2.4 (3/32"), 3.0/3.2 (1/8"), 4.0 (5/32"), 4.8/5.0 (3/16"), 6.4
 Rivetti in INOX: 2.4 (3/32"), 3.0/3.2 (1/8"), 4.0 (5/32"), 4.8/5.0 (3/16")



CODICE	€/PZ
FG 260/GP	195,00

RIVETTATRICE PER INSERTI FILETTATI CON 4 TESTINE INTERCAMBIABILI

Adatta per:

Rivetti in alluminio: M3x0.5, M4X0.7, M5X0.8, M6X1.0
 Rivetti in acciaio: M3x0.5, M4X0.7, M5X0.8, M6X1.0
 Rivetti in INOX: M3x0.5, M4X0.7, M5X0.8



CODICE	€/PZ
FG 261	135,00



RIVETTATRICE MANUALE PER RIVETTI IN PLASTICA



CODICE	€/PZ
FG 260/RP	62,50

SET



SET 10 RIVETTI IN PLASTICA

CODICE	Capacità mm	€/PZ
FG 260PR/S1	5x15.8	23,00
FG 260PR/S2	5x17.2	7,50
FG 260PR/S3	6.3x17.2	7,50
FG 260PR/S4	6.3x25.2	9,00

PROLUNGA MAGNETICA ARTICOLATA



CODICE	Capacità kg	L/mm	Ø/mm	€/PZ
FG 92/PF	3,5	400	1,5	27,50

PROLUNGA MAGNETICA TELESCOPICA



CODICE	Capacità kg	L/mm	€/PZ
FG 92/PM1	0,6	127-635	10,50

PROLUNGA MAGNETICA TELESCOPICA Impugnatura in PVC antiscivolo



CODICE	Capacità kg	L/mm	€/PZ
FG 92/PM4	2,3	165-622	27,50

PROLUNGA MAGNETICA FLESSIBILE

Impugnatura in gomma antiscivolo



CODICE	Ø/mm	L/mm asta	€/PZ
FG 92/PM	3,9	1	19,00

PROLUNGA MAGNETICA FLESSIBILE

Dotata di griffe prensili



CODICE	Capacità kg	L/mm asta	€/PZ
FG 92/GR	1	700	27,00

SPECCHIETTO TELESCOPICO E ARTICOLATO IN ACCIAIO



CODICE	Ø/mm	L/mm	€/PZ
FG 93/M50	50	240-698	30,00

SPECCHIETTO TELESCOPICO E ARTICOLATO IN ACCIAIO



CODICE	Dimensioni specchio mm	L/mm asta	€/PZ
FG 93/M95	50x95	370-775	30,00

SALDATORE ISTANTANEO A PISTOLA 100W

Classe di protezione II

Fornito con 1 punta di ricambio e stagno per saldare

PUNTA DI RICAMBIO (FG 95/TIP1) 6,00 €



CE

CODICE	Volt	Max temp.	€/PZ
FG 95/SP100	230	570°	65,00

SALDATORI A STILO

Classe di protezione I



CE

CODICE	Watt	Volt	Ø/mm	°C	€/PZ
FG 96/SS30	30	230	4	430	48,00
FG 96/SS60	60	230	6	500	60,00

PUNTA DI RICAMBIO PER SALDATURA

CODICE	Adatto per	€/PZ
FG 96/TIP1	FG 96/SS30	7,00
FG 96/TIP2	FG 96/SS60	7,00

SALDATORE A STILO A DOPPIA POTENZA

Classe di protezione I

PUNTA DI RICAMBIO (FG 96/TIP2) 6,00 €



CE

CODICE	Watt	Volt	Ø/mm	€/PZ
FG 96/SS36	30/60	230	5.8	65,00

SALDATORE PORTATILE A GAS

Autonomia 120 minuti

Dotato di 4 beccucci per saldatura, taglio, fiamma, soffio

Fornito in box di ABS



CODICE	Watt	°C	Capacità	€/PZ
FG 98/GAS	25-80	210-400	21 ml	125,00

PUNTA DI RICAMBIO



CODICE	Funzione	€/PZ
FG 98/TIP1	Saldatura	16,50
FG 98/TIP2	Taglio	16,50
FG 98/TIP3	Fiamma	16,50
FG 98/TIP4	Soffio	16,50

STAGNO A FILO PER SALDATURA

Confezione da 3 stick



CODICE	Ø/mm	€/PZ
FG 98/STA	1.0	12,00

MINI SALDATORE CON ATTACCO USB

CE



CODICE	Watt	Volt	Max temp.	€/PZ
FG 98/ST8	8	5	480°	16,50

MINI CUTTER CON ATTACCO USB

CE



CODICE	Watt	Volt	Max temp.	€/PZ
FG 98/PC8	8	5	400°	16,50



DISSALDATORE CON PUNTA ANTI-STATICA



CODICE	€/PZ
FG 98/SS	12,00

PUNTA ANTI-STATICA DI RICAMBIO PER DISSALDATORE

CODICE	€/PZ
FG 98/AS	3,00

SALDATORE PORTATILE CON BATTERIA AL LITIO

Autonomia 40 minuti continuativi
Fornito in box di ABS con punte per saldare, tagliare e soffiare
Corpo in polipropilene con inserti in gomma anti-scivolo



CE

CODICE	Temp. max\Ricarica	€/PZ
FG 98/LT	600°C	170,00

CONTENITORE PORTA MINUTERIE A SCOMPARTI GIREVOLI

4 scomparti porta minuterie girevoli
Vaschetta superiore porta minuterie
Scomparti dotati di divisori amovibili
3 piedi d'appoggio in ABS



CODICE	Altezza mm	Ø scomparti mm	€/PZ
FG 712/L4	540	3x440 - 1x300	120,00

PORTA MINUTERIE/UTENSILI DOTATO DI RUOTE GIREVOLI

2 scomparti magnetici porta minuterie
2 ampi scomparti porta utensili
Dotato di piastra centrale magnetica
3 ruote girevoli da 500mm
Materiale: in ABS resistente agli urti



CODICE	€/PZ
FG 712/A	50,00

AVVOLGICAVO AUTOMATICO 15M CON PRESA SCHUKO

Staffa a muro orientabile a 360°
Limitatore di rientro per arrestare la corsa
Sistema di bloccaggio a qualsiasi lunghezza



CE

Limitatore di rientro per arrestare la corsa

Sistema di bloccaggio a qualsiasi lunghezza

CODICE	Cavo m x mm ²	Preso	W cavo avvolto	W cavo sciolto	€/PZ
FG 225/SK1.5	15 x 3G1.5	SHUCKO - 230V AC	1000	2000	300,00
FG 225/SK2.5	15 x 3G2.5	SHUCKO - 230V AC	1600	3200	370,00

MINI FARETTO PORTATILE A LED

Corpo in alluminio anodizzato
Regolazione della luminosità
Funzione dimmer
Magneti posteriori
Doppia porta di ricarica tipo C e Micro USB
Cavo USB tipo C in dotazione



CE



Doppia porta di ricarica tipo C e micro USB

Base magnetica

CODICE	Lumen	Autonomia	Ricarica	LxH mm	€/PZ
FG 203	max 100 lm	0,2 - 3 h	0,5 h	32x28,4	25,00

MINI LAMPADA PORTATILE A LED

Design compatto
Gancio per cintura
Base magnetica
Cavo USB tipo C in dotazione



CE



Dotato di base magnetica

CODICE	Lumen	Autonomia	Ricarica	LxH mm	€/PZ
FG 204	300/100 lm	1,5 - 3 h	2,5 h	21x89	31,50

LAMPADA PORTATILE A LED

Led di puntamento superiore
Gancio estraibile
Base orientabile a 180° con magneti integrati
4 livelli di indicazione dell'autonomia residua
Cavo USB tipo C in dotazione



CE



Led superiore

Gancio estraibile

Rotazione base fino a 180°

CODICE	Lumen	Autonomia	Ricarica	LxH mm	€/PZ
FG 205	Max 420 lm (45lm top)	3- 10	4 h	60x190	85,00

LAMPADA RICARICABILE A LED CON TSC SYSTEM

NEW

Led di puntamento superiore
TSC SYSTEM, tecnologia di spegnimento automatico al contatto con superfici
Corpo in alluminio anodizzato
Doppio magnete, sulla base e sul retro
Gancio per cintura
Cavo USB tipo C in dotazione



CE



Gancio posteriore per cintura

Led di puntamento superiore

Tecnologia di spegnimento per contatto

CODICE	Lumen	Autonomia	Ricarica	LxH mm	€/PZ
FG 202	1200/600/80	1,5 - 10 h	3 h	46x115	55,00



LAMPADA RICARICABILE A LED CON CASSE WIRELESS

Led di puntamento superiore
Doppia cassa wireless da 5W
Gancio con magneti integrati, estraibile ed orientabile a 180°, per appendere o appoggiare la lampada
Grado di resistenza ad acqua e polveri IP54
Cavo USB tipo C in dotazione

NEW



CE



Doppia cassa wireless 5W

Led di puntamento superiore a 160 lumen

Gancio estraibile ed orientabile fino a 180°

CODICE	Lumen	Autonomia	Ricarica	LxH mm	€/PZ
FG 222/A	500/150 lm	3 - 14 h	4,5 h	65x164	120,00

LAMPADA DA TESTA A DOPPIO LED

Con sensore on/off contactless
4 livelli di inclinazione
Indicatore stato di carica
4 magneti posteriori per utilizzo senza banda elastica
Cavo USB tipo C in dotazione



CE



Dotata di 4 magneti posteriori per l'utilizzo senza banda elastica

4 livelli di inclinazione

Sensore on/off contactless

CODICE	Lumen	Autonomia	Ricarica	LxH mm	€/PZ
FG 213/L480	480/300/250/90 lm	1,4 - 10h	2,5 h	67x34	65,00

TORCIA RICARICABILE A LED

Cono luminoso regolabile
Indicatore stato di carica
In dotazione base di ricarica con supporto a parete e cavo USB



Piastra di supporto a parete



Cono luminoso regolabile

CE

CODICE	Lumen	Autonomia	Ricarica	LxH mm	€/PZ
FG 214/L600	600/250/60 lm	1,5 - 15 h	4 h	135x31	85,00

LAMPADA RICARICABILE A LED

Design slim
Magneti sul retro
Gancio per appendere la lampada
Grado di protezione IPX4
Cavo micro USB in dotazione



Gancio superiore



Extra piatta

CE

CODICE	Lumen	Autonomia	Ricarica	LxH mm	€/PZ
FG 206	360/180 lm	1,5 - 3h	5 h	10x249	55,00

LAMPADA RICARICABILE A LED

Led di puntamento superiore
Pivotante a 180°
Base magnetica
Indicatore stato di carica
Grado di resistenza ad acqua e polveri IP54
Cavo USB tipo C in dotazione



Ruotabile a 180°



Top led di puntamento



Ruotabile a 180°



CODICE	Lumen	Autonomia	Ricarica	H/mm	€/PZ
FG 207	300/200/100 lm (80 lm top)	3 - 6 h	6 h	300	65,00

LAMPADA RICARICABILE A LED

Led di puntamento superiore
Pivotante e girevole a 180°
3 livelli di indicazione dell'autonomia residua
Base magnetica
Gancio estraibile integrato nella base
Grado di resistenza ad acqua e polveri IP54
Grado di resistenza agli urti IK07
Cavo USB tipo C in dotazione

NEW



Selettore luminosità 60-700 lumen



Pivotante fino a 180°



Girevole fino a 180°



CODICE	Lumen	Autonomia	Ricarica	LxH mm	€/PZ
FG 207/B	700 - 60 lm	2 - 16 h	4 h	66x400	98,00

LAMPADA SOTTO COFANO RICARICABILE A LED

Lunghezza regolabile 1.300-2.060mm
Lampada portatile integrata e removibile
Dotata di sistema magnetico
Grado di protezione IPX4
4 livelli di indicazione dell'autonomia residua
Caricabatteria in dotazione



Due prodotti in uno



Lampada portatile integrata e removibile



Lampada cordless 200 Lumen

CODICE	Lumen	Autonomia	Ricarica	L/mm	€/PZ
FG 208	1200 lm (200)	3 h (2,5)	5 h	1300-2060	230,00

LAMPADA SOTTOCOFANO RICARICABILE A LED CON LENTE TRASPARENTE E SEMITRASPARENTE

Lunghezza regolabile fino a 2150mm
Ruotabile a 360°
Funzione dimmer
3 tipologie di lente disponibili
4 livelli di indicazione dell'autonomia residua
Caricabatteria in dotazione



Bright mode (1200 lm)



Comfortable mode (1100 lm)



Soft mode (600 lm)

CODICE	Lumen	Autonomia	Ricarica	L/mm	€/PZ
FG 209	1200/480 lm	3 - 10 h	4,5 h	2150	265,00



FARETTO RICARICABILE A LED

Orientabile a 360°
Dotato di base magnetica
3 livelli di indicazione dell'autonomia residua
Cavo USB in dotazione



CE



Impugnatura ergonomica

Dotata di base magnetica

Ruotabile a 360°

CODICE	Lumen	Autonomia	Ricarica	LxH mm	€/PZ
FG 210/A	700/350/100 lm	2 - 10 h	4 h	208x140	90,00

LAMPADA A TUBO PORTATILE A LED

Luce led superiore
Luce frontale bianca e frontale rossa d'emergenza
Funzione dimmer
Presse USB con funzione Power Bank
Base magnetica
Cavo USB tipo C in dotazione



CE



Luce spot 400 lumen

Ricarica USB di tipo c

Sistema di aggancio magnetico

CODICE	Lumen	Autonomia	Ricarica	L/mm	€/PZ
FG 210/B	1200/400/50 lm	3,5 - 15 h	6 h	486	85,00

LAMPADA RICARICABILE A LED

Led di puntamento superiore
Orientabile a 360°
Base magnetica
Grado di protezione IP20
Cavo USB tipo C in dotazione



Orientabilità a 360°

CE

CODICE	Lumen	Autonomia	Ricarica	H/mm	€/PZ
FG 212	200/60 lm	2 - 5 h	2,5 h	174	78,00

LAMPADA RICARICABILE A LED

Led di puntamento superiore
Regolatore di luminosità
Orientabile a 360°
Design sottile del corpo in polipropilene con inserti in gomma antiscivolo
5 livelli di indicazione dell'autonomia residua
Base magnetica con gancio estraibile e regolabile
in 9 posizioni
Grado di resistenza ad acqua e polveri IP54
Caricabatterie in dotazione



Top led puntamento



Orientabilità a 360°



Base magnetica e gancio estraibile

CE

CODICE	Lumen	Autonomia	Ricarica	H/mm	€/PZ
FG 211	da 600 a 60 lm	1,5 - 16 h	4 h	385	110,00

LAMPADA RICARICABILE A 3 FARI LED

2 modalità di temperatura colore (fredda 6500K/calda 4000K)
3 fari led pivotanti (180°) e rotanti (270°)
Indicatore stato di carica
Base magnetica e gancio estraibile
In dotazione treppiedi telescopico regolabile in altezza da 665 mm fino a 1420 mm
Caricabatterie in dotazione



CE



Magnete Gancio estraibile Pannello di controllo

CODICE	Lumen	Autonomia	Ricarica	H/mm	€/PZ
FG 217	2000/1200/700 lm	2 - 8 h	5 h	1420-665	250,00

FARETTO DA LAVORO RICARICABILE A LED

Funzione Power Bank (Output max USB 5V 2A)
Supporto orientabile a 180°
5 livelli di indicazione dell'autonomia residua
Grado di resistenza ad acqua e polveri IP65
Grado di resistenza agli urti IK07
Indice di resa cromatica CRI 70+
Cavo USB tipo C in dotazione

NEW



CE



Supporto orientabile 180° Funzione power bank Grado di resistenza IP65

CODICE	Lumen	Autonomia	Ricarica	LxH mm	€/PZ
FG 210/C	3000/2250/1500/750/300	3 - 25 h	5,5 h	208x140	165,00

FARO DA LAVORO RICARICABILE A LED CON CASSE WIRELESS

NEW

Doppia cassa wireless da 10W
Funzione Power Bank (Output max USB 5V 1A)
Corpo orientabile a 140°
5 livelli di indicazione dell'autonomia residua
Gancio estraibile e girevole integrato nella base
Grado di resistenza ad acqua e polveri IP65
Caricabatterie in dotazione



CE



Casse wireless 10W Corpo orientabile a 140° Gancio estraibile e girevole integrato

CODICE	Lumen	Autonomia	Ricarica	LxH mm	€/PZ
FG 222/B	4000/2000/1000/400	3,5 - 18 h	3,5 h	210x210	350,00

FARO DA LAVORO A DOPPIO CORPO ILLUMINANTE

NEW

Rotazione orizzontale di 180° per faro: illumina efficacemente diverse aree dell'ambiente di lavoro
Corpo orientabile a 90°
Batteria al litio estraibile da 14,8V con funzione Power Bank (Output max USB 5V 2A)
5 livelli di indicazione dell'autonomia residua
Caricabatteria in dotazione



CE



Batteria estraibile Corpi illuminanti orientabili fino a 180° Batteria a litio con funzione power bank

CODICE	Lumen	Autonomia	Ricarica	LxH mm	€/PZ
FG 221	4500/3000/1500/750	2 - 12 h	4,5 h	190x295	340,00



FARO DA CANTIERE RICARICABILE A LED CON LENTE ANTIABBAGLIAMENTO

Speciale lente opaca che riduce l'effetto abbagliamento ed aumenta la diffusione della luce
 Supporto orientabile a 180° ed agganciabile al treppiedi
 3 livelli di indicazione dell'autonomia residua
 Grado di resistenza ad acqua e polveri IP65
 Grado di resistenza agli urti IK07
 Caricabatterie in dotazione

NEW



CE



Orientabile fino a 180°

Grado di resistenza IP65

CODICE	Lumen	Autonomia	Ricarica	LxH mm	€/PZ
FG 224/L5200	5200/2000/1000/400	2 - 16 h	3,5 h	273x205	250,00

TREPPIEDI PER FARO DA CANTIERE FG 224/L5200

Altezza massima 1,60 m

NEW



CODICE	€/PZ
FG 224/SU	100,00



LAMPADE PER CONTROLLO COLORE

LAMPADA DA TESTA LED AD ELEVATO INDICE DI RESA CROMATICA PER CONTROLLO COLORE

Alto indice di resa cromatica CRI 96+
3 opzioni di temperatura colore 2700K/4500K/ 6500K
Sensore ON/OFF contactless
Indicatore stato di carica
4 livelli di inclinazione
Cavo USB in dotazione

**COB LED - cri 96+
3 COLORI**

2700K 4500K 6500K



CE



Sensore on/off contactless 4 livelli di inclinazione

CODICE	Lumen	Autonomia	Ricarica	LxH mm	€/PZ
FG 234	160 lm	3 h	3 h	50x50	105,00

LAMPADA RICARICABILE A LED AD ELEVATO INDICE DI RESA CROMATICA PER CONTROLLO COLORE

Alto indice di resa cromatica CRI 96+
3 opzioni di temperatura colore 2700K/4500K/ 6500K
Lente sostituibile
Magnete sul retro e sulla base pivotante
Gancio estraibile rotante a 360°
Grado di resistenza ad acqua e polveri IP65
Grado di resistenza agli urti IK07
Base di ricarica da tavolo con presa USB + cavo USB in dotazione

**COB LED - cri 96+
3 COLORI**

2700K 4500K 6500K

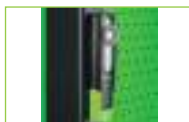

Base magnetica + super magnete sul retro



Lente sostituibile



Gancio estraibile

CE

CODICE	Lumen	Autonomia	Ricarica	LxH mm	€/PZ
FG 235	500/250 lm	2,5 - 4 h	4 h	50x190	135,00

FARO RICARICABILE A LED AD ELEVATO INDICE DI RESA CROMATICA PER CONTROLLO COLORE

Alto indice di resa cromatica CRI 96+
5 opzioni di temperatura colore 2700K/3500K/4500K/5500K/6500K
Base pivotante a 180°
Pannello comandi sul retro con doppio led per indicazione di intensità e temperatura colore
Funzione memoria sui parametri dell'ultimo utilizzo
Grado di resistenza ad acqua e polveri IP65
Grado di resistenza agli urti IK07
Caricabatterie con cavo lungo 5 m in dotazione

**LED - cri 96+
5 COLORI**

2700K 3500K 4500K 5500K 6500K



CE



Pannello di controllo



Caricabatterie a sgancio rapido con cavo da 5 m



CODICE	Lumen	Autonomia	Ricarica	LxH mm	€/PZ
FG 236	2000/1000/500 lm	2 - 8 h	3,5 h	115x190	335,00

TREPIEDI PER FARO LED FG 236

Altezza 476 mm (chiuso) - 1440 mm (aperto)
Numero di estensioni dei piedi 3



CODICE	Peso	Portata max	€/PZ
FG 236/SU	1,1 kg	2 kg	100,00



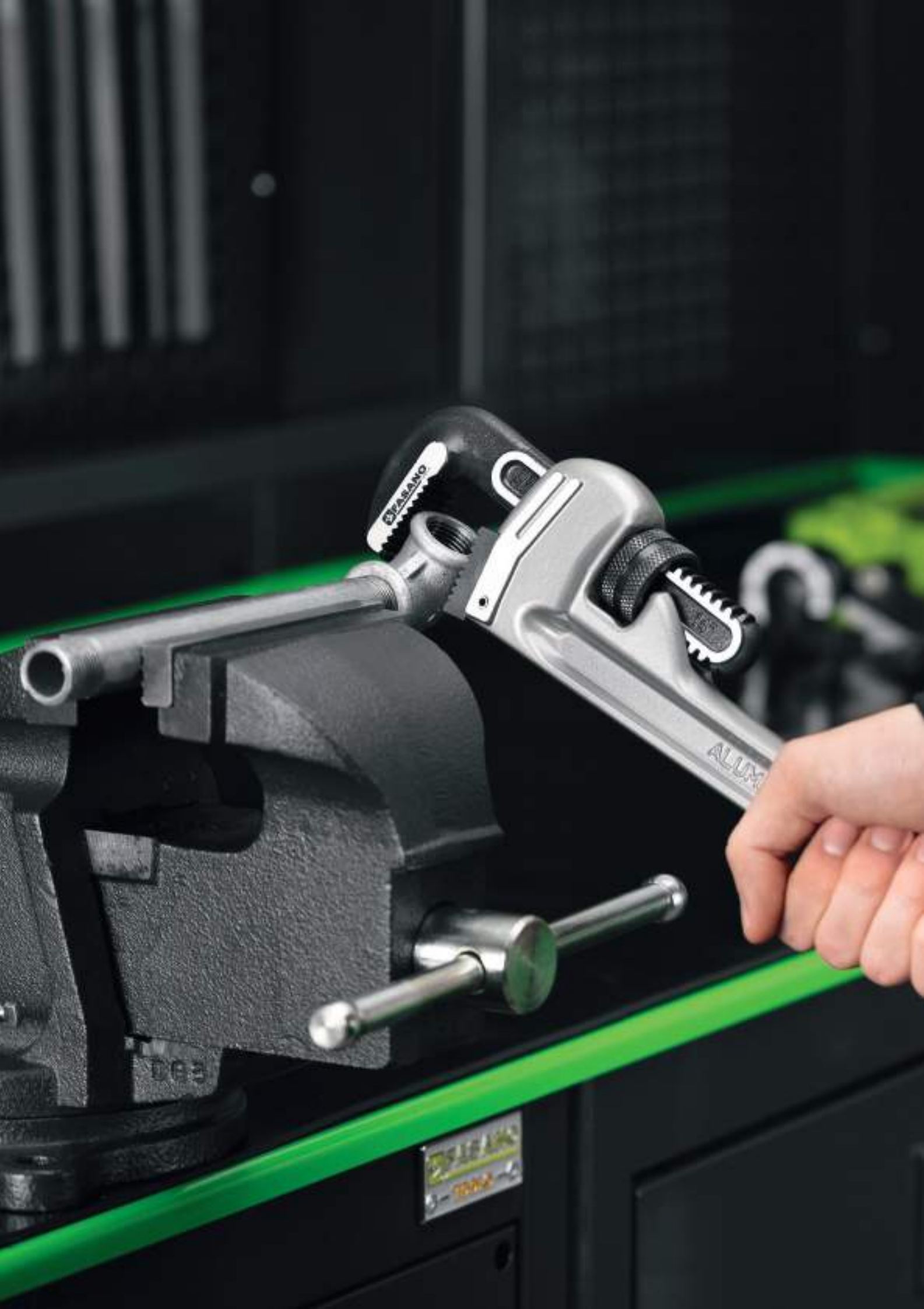

13

UTENSILI PER IDRAULICA



GIRATUBI MODELLO AMERICANO



CODICE	Ø Gas max	Ø mm max	L/mm	€/PZ
FG 30/GA1	1"	34	200	30,00
FG 30/GA1.5	1"1/2	49	250	40,00
FG 30/GA2	2"	60	300	48,00
FG 30/GA2B	2"	60	350	56,00
FG 30/GA2.5	2"1/2	76	450	82,00
FG 30/GA3	3"	90	600	125,00

GIRATUBI MODELLO AMERICANO IN LEGA LEGGERA



CODICE	Ø Gas max	Ø mm max	L/mm	€/PZ
FG 33/GA2	2"	60	350	70,00
FG 33/GA2.5	2"1/2	76	450	98,00
FG 33/GA3	3"	90	600	148,00
FG 33/GA5	5"	140	900	298,00

GIRATUBI MODELLO SVEDESE CON GANASCE PARALLELE A 45°



CODICE	Ø Gas max	Ø mm max	L/mm	€/PZ
FG 32/GP1	1"	34	320	32,00
FG 32/GP1.5	1"1/2	49	410	45,00
FG 32/GP2	2"	60	550	70,00

GIRATUBI MODELLO SVEDESE CON GANASCE SOTTILI A 45°



CODICE	Ø Gas max	Ø mm max	L/mm	€/PZ
FG 32/GS1	1"	34	320	32,00
FG 32/GS1.5	1"1/2	49	410	45,00
FG 32/GS2	2"	60	550	70,00

GIRATUBI MODELLO LEGGERO



CODICE	Ø Gas max	Ø mm max	L/mm	€/PZ
FG 34/GL1	1"	34	175	20,00
FG 34/GL1.5	1"1/2	49	225	25,00

ATTREZZO BORDATUBI PER RAME E LEGHE LEGGERE



CODICE	Ø mm	€/PZ
FG 20/A2	4, 4.75, 6, 8, 10, 12, 14	56,00

BORCHIE PER BORDA TUBI



CODICE	mm	€/PZ
FG 20/AD4	4	5,00
FG 20/AD4.75	4.75	5,00
FG 20/AD6	6	5,00
FG 20/AD8	8	5,00
FG 20/AD10	10	5,00
FG 20/AD12	12	5,00
FG 20/AD14	14	5,00

SET UTENSILI PER IDRAULICA



CODICE	Contenuto	€/PZ
FG 21/S10	FG 20/A2 FG 20/AD4 - FG 20/AD14 FG 76/R2	145,00

CURVATUBI PER RAME E LEGHE LEGGERE



CODICE	Capacità	€/PZ
FG 24/CU1	6, 8, 10 mm	40,00
FG 24/CU2	1/4", 5/16", 3/8"	40,00

CHIAVE PER DADI RUBINETTI STANDARD



CODICE	Ø mm	€/PZ
FG 21/CD	10-32, 8"-1.1/4"	31,00

CHIAVE A CROCE PER SANITARI



CODICE	€/PZ
FG 21/CS	55,00

CHIAVE PER RACCORDI RADIATORE



CODICE	€/PZ
FG 21/CR	38,00

CHIAVE REGOLABILE A RULLINO, CON SCALA GRADUATA



CODICE	Ø mm max	L/mm	€/PZ
FG 35/B1	15	100/4"	20,00
FG 35/B2	24	150/6"	20,50
FG 35/B3	28	200/8"	25,50
FG 35/B4	34	250/10"	32,00
FG 35/B5	35	300/12"	41,00

CHIAVE REGOLABILE A RULLINO, SERIE SPECIAL SUPER LEGGERA



CODICE	Ø mm max	L/mm	€/PZ
FG 35/1	24	150/6"	19,00

SBAVATORE A RASCHIETTO CON LAMA INTERCAMBIABILE GIREVOLE



CODICE	L/mm	€/PZ
FG 79/SR	148	16,50

LAMA DI RICAMBIO SBAVATORE A RASCHIETTO

CODICE	€/PZ
FG 79/SR1R	6,00

SBAVATORE PER INTERNI ED ESTERNI IN METALLO



CODICE	Capacità mm	L/mm	€/PZ
FG 79/SB	8-38 1/8" - 1.5/8"	58	23,00







14

BORSE DA LAVORO



CASSETTA PORTA-UTENSILI A 3 SCOMPARTI

Predisposizione per lucchetto di chiusura
Struttura in lamiera d'acciaio 0.6mm
Divisorio scomparto superiore
Cerniere di chiusura doppie



CODICE	Dimensioni mm	€/PZ
FG 111/A	430x160x200	60,00

CASSETTA PORTA-UTENSILI A 5 SCOMPARTI

Predisposizione per lucchetto di chiusura
Struttura in lamiera d'acciaio 0.6mm
Divisorio scomparto superiore
Cerniere di chiusura doppie



CODICE	Dimensioni mm	€/PZ
FG 111/B	430x200x200	72,00
FG 111/C	530x200x200	88,00



BAULE PORTA UTENSILI IN LAMIERA

Dotato di maniglioni laterali richiudibili
Predisposizione per lucchetto di chiusura
Struttura in lamiera d'acciaio 0.8mm

NEW



CODICE	Dimensioni mm	Spessore lamiera mm	€/PZ
FG 113/A	520x290x290	1	175,00
FG 113/B	650x350x350	1	210,00
FG 113/C	850x350x350	1	250,00
FG 113/D	1000x400x450	1.5	300,00

SCOMPARTO PER BAULE PORTAUTENSILI

NEW



CODICE	Dimensioni mm	Per	€/PZ
FG 113/A-VA	390x244x50	FG 113/A	32,00
FG 113/B-VA	500x306x50	FG 113/B - FG 113/C	42,00
FG 113/D-VA	500x400x50	FG 113/D	50,00

CASSETTA PORTA-UTENSILI A 5 SCOMPARTI CON ASSORTIMENTO 55 UTENSILI



CODICE	Contenuto	€/PZ
FG 111/AS55	55 pz	642,50

- FG 625/A: chiavi a bussola esagonali 1/2" 8-32mm
- FG 625/CR12: cricchetto reversibile con attacco quadro 1/2"
- FG 625/PR125: prolunga con attacco quadro 1/2" - 125mm
- FG 625/PR250: prolunga con attacco quadro 1/2" - 250mm
- FG 625/SN12: snodo universale con attacco quadro 1/2"
- FG 625/ES12: maschio scorrevole con attacco quadro 1/2"
- FG 22/...: giraviti a taglio 3x75, 4x100, 5.5x100, 6.5x100
- FG 22/PH: giraviti a croce ph1x80, ph2x100
- FG 69/CJ250: pinza autobloccante 250mm
- FG 35/B4: chiave a rullino mm250
- FG 59PV/180: pinza universale -180mm
- FG 61PV/160: pinza becchi mezzotondi -160mm
- FG 63PV/160: tronchese taglienti diagonali -160mm
- FG 139/B: set 10 chiavi maschio a L esagonale corto
- FG 600/SP11: set 11 chiavi combinate in rotolo di nylon 8-19mm

CASSETTA PORTA-UTENSILI A 5 SCOMPARTI CON ASSORTIMENTO 104 UTENSILI



CODICE	Contenuto	€/PZ
FG 111/AS104	104 pz	863,50

- FG 625/A: chiavi a bussola esagonali 1/2" 8-19mm
- FG 625/CR12: cricchetto reversibile con attacco quadro 1/2"
- FG 625/PR250: prolunga con attacco quadro 1/2" - 250mm
- FG 625/SN12: snodo universale con attacco quadro 1/2"
- FG 625/ES12: maschio scorrevole con attacco quadro 1/2"
- FG 624/S25: set chiavi a bussola 1/4" + cricchetto e accessori
- FG 22/...: giraviti a taglio 3x100, 4x125, 5.5x150, 6.5x150
- FG 22/PH: giraviti a croce ph1x80, ph2x100
- FG 58/B240: pinza regolabile a cerniera 240mm
- FG 69/cj250: pinza autobloccante 250mm
- FG 85/S31: set 30 inserti da 1/4" + porta inserti
- FG 43/MT3: flessometro 3mt
- FG 132/500: pinza universale -180mm
- FG 59PV/180: martello con manico in resina - 500gr
- FG 63PV/160: tronchese taglienti diagonali -160mm
- FG 139/B: set 10 chiavi maschio a L esagonale corto
- FG 48/LG: cutter a lama lunga
- FG 49: forbice per elettricista
- FG 600/SP9: set 9 chiavi combinate in rotolo di nylon 18-19mm



VALIGIA PORTAUTENSILI IN ABS

Maniglione a scomparsa per facilitarne il trasporto
 Sistema di chiusura rinforzato
 Porta etichette
 Predisposizione per lucchetto di chiusura



CODICE	Dimensioni mm	Peso kg	€/PZ
FG 1425	456x372x115	2.1	102,00

VALIGIA PORTAUTENSILI IN ABS

Maniglione a scomparsa per facilitarne il trasporto
 Sistema di chiusura rinforzato
 Porta etichette
 Predisposizione per lucchetto di chiusura



CODICE	Dimensioni mm	Peso kg	€/PZ
FG 1426	456x372x155	2.4	120,00

VALIGIA PORTAUTENSILI IN ABS

Maniglione a scomparsa per facilitarne il trasporto
 Sistema di chiusura rinforzato
 Porta etichette
 Predisposizione per lucchetto di chiusura



CODICE	Dimensioni mm	Peso kg	€/PZ
FG 1427	456x372x262	3	170,00

VALIGIA PORTAUTENSILI DOTATA DI BOX INTERNI IN ABS

Maniglione a scomparsa per facilitarne il trasporto
 Sistema di chiusura rinforzato
 Porta etichette
 Predisposizione per lucchetto di chiusura



CODICE	Dimensioni mm	Peso kg	€/PZ
FG 1434	456x372x115	3.2	145,00

BOX INTERNI IN ABS

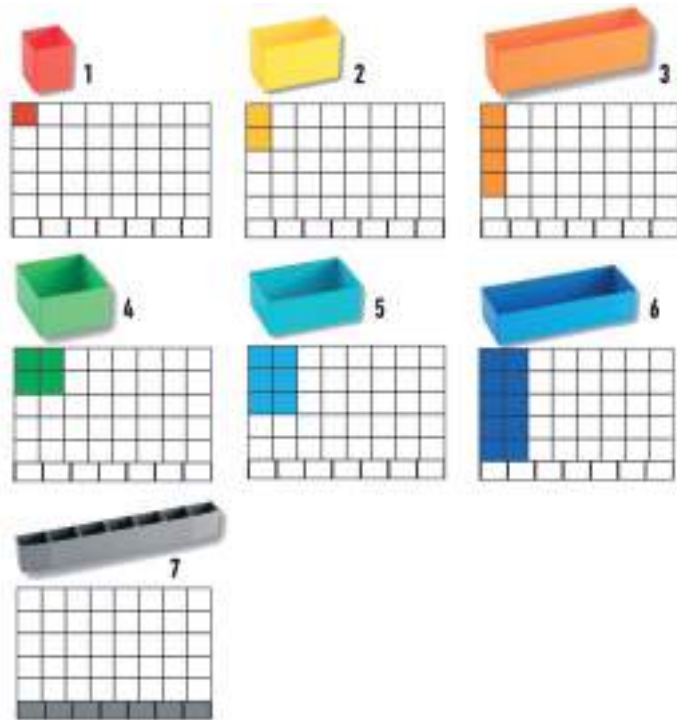

CODICE	N°	€/PZ
FG 1434/V1	1	1,50
FG 1434/V2	2	2,00
FG 1434/V3	3	4,00
FG 1434/V4	4	3,50
FG 1434/V5	5	4,00
FG 1434/V6	6	6,50
FG 1434/V7	7	9,00

TERMOFORMATO IN SPUGNA



CODICE	€/PZ
FG 1434/EF	15,00

BASE D'APPOGGIO CON RUOTE PER VALIGIE IMPILABILI

Ruote Ø 90 mm, di cui 2 frenanti
Sistema di bloccaggio



CODICE	Dimensioni mm	Peso kg	Portata kg	€/PZ
FG 1432	655x490x170	2,4	100	130,00

CARRELLO PIEGHEVOLE RICHIUDIBILE

Ruote Ø 180 mm
Struttura in ferro - base in alluminio



CODICE	Aperto mm	Chiuso mm	Base mm	Peso kg	Portata	€/PZ
FG 1433	1080x490x525	835x485x70	480x350	6	100	190,00



CARRELLO PORTA OGGETTI PIEGHEVOLE

Sistema di bloccaggio



CODICE	Dimensioni mm	Peso kg	Portata kg	€/PZ
FG 109/L3	945x485x810	11	300	280,00

VALIGIA PORTA-UTENSILI IN ABS

Due scomparti sovrapponibili e separabili
Finestre anteriori trasparenti
Maniglia ergonomica orientabile e regolabile



CODICE	Dimensioni mm	€/PZ
FG 114/L2	420x300x250	65,00

KIT 4 VALIGIE IN ABS IMPILABILI CON BASE D'APPOGGIO

Contiene: FG 1434; FG 1425, FG 1426, FG 1427, FG 1432

Una valigia dotata di box interni



CODICE	Peso kg	Portata kg	€/PZ
FG 1438/S4B	13.1	100	680,00

CASSETTA PORTA-UTENSILI A 3 RIPIANI



CODICE	Dimensioni mm	€/PZ
FG 114/L3	370x250x250	110,00

KIT 4 VALIGIE IN ABS IMPILABILI CON CARRELLO PIEGHEVOLE

Contiene: FG 1434; FG 1425, FG 1426, FG 1427, FG 1432

Una valigia dotata di box interni



CODICE	€/PZ
FG 1438/S4C	730,00

BOX PORTAMINUTERIE DOTATO DI 8 CONTENITORI ASPORTABILI E DIVISORI REGOLABILI



CODICE	Dimensioni mm	€/PZ
FG 1445	385x320x60	45,00

CONTENITORE ASPORTABILE PER BOX PORTAMINUTERIE



CODICE	Dimensioni mm	€/PZ
FG 1445/V1	90x60x50	3,00

SET 10 DIVISORI PER BOX PORTAMINUTERIE



CODICE	€/PZ
FG 1445/D	5,50

BOX PORTAMINUTERIE DOTATO DI 12 CONTENITORI ASPORTABILI



CODICE	Dimensioni mm	€/PZ
FG 1440	400x400x70	60,00

CONTENITORE ASPORTABILE PER BOX PORTAMINUTERIE



CODICE	Dimensioni mm	€/PZ
FG 1440/V1	95x75x65	3,00

CONTENITORE ASPORTABILE PER BOX PORTAMINUTERIE



CODICE	Dimensioni mm	€/PZ
FG 1440/V2	145x75x65	4,00

BORSA PORTA-UTENSILI CON SISTEMA DI SEDUTA

Borsa in tessuto tecnico
Comodo sistema di seduta
Struttura in acciaio rinforzata e richiudibile
Facilmente richiudibile e trasportabile
Gommini di appoggio anti-graffio



CODICE	Dimensioni mm	€/PZ
FG/XTV	400x340x290	120,00

BORSA PORTA-UTENSILI CON SISTEMA DI SEDUTA

Borsa in tessuto tecnico
Comodo sistema di seduta
Struttura in acciaio rinforzata e richiudibile
Facilmente richiudibile e trasportabile
Gommini di appoggio anti-graffio



CODICE	Dimensioni mm	€/PZ
FG/XT V2	400x340x290	120,00



VALIGIA PORTA UTENSILI IN CUOIO PER ELETTRICISTI

Due tasche porta-utensili
Tracolla in pelle



CODICE	Dimensioni mm	€/PZ
FG/XTP1	230x90x290	140,00

BORSA PORTA-UTENSILI IN TESSUTO TECNICO

Pannelli interni removibili
2 tasche frontali porta-documenti
Cinta regolabile
Borsa in tessuto tecnico impermeabile



CODICE	Dimensioni mm	€/PZ
FG/EBV	368x244x200	40,00

TROLLEY PORTAUTENSILI IN TESSUTO

Tessuto tecnico ad elevata resistenza
Manico telescopico e 2 ruote resistenti per il facile trasporto
Struttura rigida con ampio scomparto interno per l'alloggiamento di utensili elettrici, utensili manuali ed accessori
Tasche interne ed esterne per un'ottimale organizzazione dello spazio
2 tasche esterne frontali chiuse

NEW



CODICE	Dimensioni	€/PZ
FG 1456	470x330x270	230,00

BORSA PORTA UTENSILI IN TESSUTO

Struttura rigida in tessuto tecnico ad elevata resistenza
Base in plastica rigida per la protezione del contenuto
Due ampi scomparti separati
Tasche multiple e passanti interni ed esterni
Tasche chiuse sul retro e sul fronte
Comoda maniglia e tracolla imbottita regolabile

NEW



CODICE	Dimensioni	€/PZ
FG 1454	450x250x330	180,00

CESTELLO PORTA UTENSILI IN TESSUTO CON COVER

Struttura rigida in tessuto tecnico ad elevata resistenza
 Base in plastica rigida per la protezione del contenuto
 Ampio scomparto aperto per facile accesso al contenuto
 Cover di chiusura con velcro a scomparsa
 Maniglione in metallo con impugnatura in gomma morbida
 Tasche multiple e passanti interni ed esterni
 Tasca chiusa laterale e tasca porta seghetto frontale
 Tracolla imbottita regolabile

NEW



CODICE	Dimensioni	€/PZ
FG 1452	500x260x360	140,00

BORSA PORTA UTENSILI IN TESSUTO

Tessuto tecnico ad elevata resistenza
 Base semi rigida con rialzi in plastica
 Ampio vano centrale
 Tasche multiple interne ed esterne
 Tasca chiusa sul retro e doppia tasca chiusa frontale con passanti
 Tracolla imbottita regolabile

NEW



CODICE	Dimensioni	€/PZ
FG 1450	460x290x320	132,00

ZAINO PORTAUTENSILI IN TESSUTO

Tessuto tecnico ad elevata resistenza
 Base in plastica rigida per la protezione del contenuto
 Doppio vano interno, porta utensili e porta pc e documenti
 Tasche multiple laterali e frontali, interne ed esterne
 Schienale ergonomico imbottito
 Spallacci imbottiti e cinturino pettorale regolabile

NEW



CODICE	Dimensioni	€/PZ
FG 1460	310x220x460	150,00

ZAINO PORTAUTENSILI IN TESSUTO CON RUOTE

Dimensioni bagaglio a mano
 Tessuto tecnico ad elevata resistenza
 Manico telescopico a scomparsa
 Ruote integrate con cover richiudibile
 Doppio vano interno, porta utensili e porta pc e documenti
 Tasche multiple laterali e frontali, interne ed esterne
 Schienale ergonomico imbottito
 Spallacci imbottiti e cinturino pettorale regolabile richiudibile in apposita tasca

NEW



CODICE	Dimensioni	€/PZ
FG 1465	350x200x520	200,00



VALIGIA PORTA-UTENSILI IN POLIPROPILENE - MODELLO BASIC

Serratura centrale con chiave
Sistema porta utensili ad elastico
Dotata di piedi di appoggio
Fondo termoformato porta oggetti
2 box in plastica per minuteria



CODICE	Dimensioni mm	€/PZ
FG 115/A	430x156x340	250,00

VALIGIA PORTA-UTENSILI IN POLIPROPILENE AD ALTA RESISTENZA

Due serrature laterali con chiave
Sistema porta utensili ad elastico
Dotata di piedini d'appoggio
3 cerniere posteriori in metallo
Fondo con divisori amovibili
Dotata di vano targhetta porta nome



CODICE	Dimensioni mm	€/PZ
FG 116/A	465x215x352	390,00

VALIGIA PORTA-UTENSILI IN ABS TERMOFORMATATO

Due serrature laterali con chiave
Sistema porta utensili a tasche
Dotata di piedini d'appoggio
Fondo termoformato porta oggetti



CODICE	Dimensioni mm	€/PZ
FG 115/B	453x190x332	290,00

VALIGIA PORTA-UTENSILI IN ABS TERMOFORMATATO

Due serrature laterali con chiave
Sistema porta utensili a tasche
Dotata di piedini d'appoggio
Fondo termoformato porta oggetti
Sistema trolley integrato



CODICE	Dimensioni mm	€/PZ
FG 117/A	453x197x332	450,00

ASSORTIMENTO 76 UTENSILI PER ELETTROTECNICA



CODICE	Contenuto	€/PZ
FG 118/AS76	76 pz	870,40

- FG 22E/2.5x75:** giravite isolato a taglio 2.5x75 mm
- FG 22E/3x100:** giravite isolato a taglio 3x100 mm
- FG 22E/4x100:** giravite isolato a taglio 4x100 mm
- FG 22E/5.5x125:** giravite isolato a taglio 5.5x125 mm
- FG 22E/6.5x150:** giravite isolato a taglio 6.5x150 mm
- FG 22E/PH0x60:** giravite isolato a croce PH0x60
- FG 22E/PH1x80:** giravite isolato a croce ph1x80
- FG 22E/PH2x100:** giravite isolato a croce ph2x100
- FG 128/BU2:** bullino a percussione
- FG 126/SL1:** scalpello lungo per elettricisti
- FG 126/SL2:** scalpello lungo per elettricisti
- FG 127/P1:** scalpello piatto mm26x240l
- FG 93/M24:** specchietto telescopico articolato
- FG 602/SP9:** set 9 chiavi a doppia forchetta 6x7-21x23mm
- FG 139/C:** set 10 chiavi maschio a l esagonale lungo
- FG 138/C:** set 10 chiavi maschio a l torx lungo
- FG 96/SS36:** saldatore a stilo 30/60w
- FG 22/FX5:** giravite a bussola 5mm
- FG 22/FX6:** giravite a bussola 6mm
- FG 22/FX7:** giravite a bussola 7mm
- FG 22/FX8:** giravite a bussola 8mm
- FG 22/FX10:** giravite a bussola 10mm
- FG 22/FX13:** giravite a bussola 13mm
- FG 58/IS250:** pinza isolata regolabile a cerniera
- FG 59/IS180:** pinza universale isolata - 180mm
- FG 61/IS200:** pinza isolata becchi mezzotondi -200mm
- FG 63/IS160:** tronchese diagonale isolata -160mm
- FG 68IS/160:** pinza spellafilati isolata -160mm
- FG 49:** forbice per elettricista
- FG 48/IS:** cutter isolato per elettricisti
- FG 68/S1:** pinza x capicorda non-isolati
- FG 22/CF250:** giravite cercafase 110-250v
- FG 68/CS2:** spellafilati 8-28mm
- FG 48/L:** cutter professionale a lama lunga

ASSORTIMENTO 40 UTENSILI PER ELETTROTECNICA



CODICE	Contenuto	€/PZ
FG 118/AS40	40 pz	1.083,40

- FG 22E/2.5x75:** giravite isolato a taglio 2.5x75 mm
- FG 22E/3x100:** giravite isolato a taglio 3x100 mm
- FG 22E/4x100:** giravite isolato a taglio 4x100 mm
- FG 22E/5.5x125:** giravite isolato a taglio 5.5x125 mm
- FG 22E/6.5x150:** giravite isolato a taglio 6.5x150 mm
- FG 22E/8x175:** giravite isolato a taglio 8x175 mm
- FG 22E/PH0x60:** giravite isolato a croce PH0x60
- FG 22E/PH1x80:** giravite isolato a croce PH1x80
- FG 22E/PH2x100:** giravite isolato a croce PH2x100
- FG 22E/PH3x150:** giravite isolato a croce PH 3x150
- FG 22E/PZ0x60:** giravite isolato a croce PZ 0x60
- FG 22E/PZ1x80:** giravite isolato a croce PZ 1x80
- FG 22E/PZ2x100:** giravite isolato a croce PZ 2x100
- FG 22E/PZ3x150:** giravite isolato a croce PZ 3x150
- FG 96/SS36:** saldatore a stilo 30/60w
- FG 98/SS:** pompetta succhia stagno
- FG 22/FX5:** giravite a bussola 5mm
- FG 22/FX6:** giravite a bussola 6mm
- FG 22/FX7:** giravite a bussola 7mm
- FG 22/FX8:** giravite a bussola 8mm
- FG 22/FX10:** giravite a bussola 10mm
- FG 22/FX13:** giravite a bussola 13mm
- FG 58/IS250:** pinza isolata regolabile a cerniera
- FG 59/IS180:** pinza universale isolata - 180mm
- FG 61/IS200:** pinza isolata becchi mezzotondi -200mm
- FG 63/IS160:** tronchese diagonale isolata -160mm
- FG 68IS/160:** pinza spellafilati isolata -160mm
- FG 49/E:** forbice isolata per elettricista
- FG 48/IS:** cutter isolato per elettricisti
- FG 603/SP6:** set chiavi a forchetta semplice isolata 8-19mm
- FG 22/CF250:** giravite cercafase 110-250v
- FG 35/E250:** chiave regolabile a rullino isolata
- FG 136/L35:** mazzuola anti-rimbalzo -35gr
- FG 93/P:** specchietto rigido in plastica



ASSORTIMENTO 56 UTENSILI PER ELETTROTECNICA



CODICE	Contenuto	€/PZ
FG 118/AS56	56 pz	780,90

- FG 22E/2.5x75: giravite isolato a taglio 2.5x75 mm
- FG 22E/3x100: giravite isolato a taglio 3x100 mm
- FG 22E/4x100: giravite isolato a taglio 4x100 mm
- FG 22E/5.5x125: giravite isolato a taglio 5.5x125 mm
- FG 22E/6.5x150: giravite isolato a taglio 6.5x150 mm
- FG 22E/PH0x60: giravite isolato a croce PH0x60
- FG 22E/PH1x80: giravite isolato a croce PH1x80
- FG 22E/PH2x100: giravite isolato a croce PH2x100
- FG 129/C4: cacciaspine 4mm
- FG 129/C5: cacciaspine 5mm
- FG 126/SL1: scalpello lungo per elettricisti
- FG 126/SL2: scalpello lungo per elettricisti
- FG 127/P1: scalpello piatto mm26x240l
- FG 602/SP9: set 9 chiavi a doppia forchetta 6x7-21x23mm
- FG 139/C: set 10 chiavi maschio a L esagonale lungo
- FG 96/SS36: saldatore a stilo 30/60w
- FG 22/FX5: giravite a bussola 5mm
- FG 22/FX6: giravite a bussola 6mm
- FG 22/FX7: giravite a bussola 7mm
- FG 22/FX8: giravite a bussola 8mm
- FG 22/FX10: giravite a bussola 10mm
- FG 22/FX13: giravite a bussola 13mm
- FG 58/IS250: pinza isolata regolabile a cerniera
- FG 59/IS180: pinza universale isolata - 180mm
- FG 61/IS200: pinza isolata becchi mezzotondi -200mm
- FG 63/IS160: tronchese diagonale isolata -160mm
- FG 68IS/160: pinza spellafili isolata -160mm
- FG 49: forbice per elettricista
- FG 48/IS: cutter isolato per elettricisti
- FG 68/S1: pinza x capicorda non-isolati
- FG 22/CF250: giravite cercafase 110-250v
- FG 68/CS2: spellafili 8-28mm
- FG 48/L: cutter professionale a lama lunga
- FG 136/L35: mazzuola anti-rimbalzo -35gr

ASSORTIMENTO 44 UTENSILI PER IDRAULICA



CODICE	Contenuto	€/PZ
FG 118/AS44	44 pz	589,60

- FG 602/SP9: set 9 chiavi a doppia forchetta 6x7-21x23mm
- FG 126/SN3: scalpello nervato
- FG 58/B240: pinza regolabile cerniera 240mm
- FG 32/GP1: giratubi con ganasce parallele 45°-1"
- FG 34/GL1.5: giratubi modello leggero 1"1/2
- FG 76/R3: tagliatubi telescopico 3-35mm
- FG 69/CJ250: pinza autobloccante 250mm
- FG 35/B4: chiave a rullino mm250
- FG 22/3x75: giravite a taglio 3x75mm
- FG 22/4x100: giravite a taglio 4x100mm
- FG 22/5.5x150: giravite a taglio 5.5x150mm
- FG 22/8x200: giravite a taglio 8x200mm
- FG 22/PH1x80: giravite a croce PH 1x80
- FG 22/PH2x100: giravite a croce PH 2x100
- FG 132/300: martello tedesco con manico in resina
- FG 46/FR2: metro 2 m in fibra di vetro
- FG 59SR/180: pinza universale -180mm
- FG 49: forbice per elettricista
- FG 49/HE300: forbice multiuso mod. pesante 300mm
- FG 94/300: livella magnetica 300mm
- FG 44/MT5: flessometro in nylon 5mx25mm
- FG 80/8AP: lima piatta taglio mezzodolce 200mm
- FG 80/8AQ: lima quadra taglio mezzodolce 200mm
- FG 81/MS: matita x falegname
- FG 79/SP3: spazzola fili rigidi in acciaio
- FG 79/SR: sbavatore a cricchetto
- FG 139/C: set 10 chiavi maschio a L esagonale lungo

ASSORTIMENTO 75 UTENSILI PER MANUTENZIONE GENERALE



CODICE	Contenuto	€/PZ
FG 118/AS75	75 pz	592,30

FG 602/SP9: set 9 chiavi a doppia forchetta 6x7-21x23mm
FG 22/2.5x75: giravite a taglio 2.5x75mm
FG 22/3.5x100: giravite a taglio 3.5x100mm
FG 22/4x150: giravite a taglio 4x150mm
FG 22/6.5x150: giravite a taglio 6.5x150mm
FG 22/8x150: giravite a taglio 8x150mm
FG 22/PH0x60: giravite a croce PH0x60
FG 22/PH1x80: giravite a croce PH1x80
FG 22/PH2x150: giravite a croce PH2x150
FG 58/B240: pinza regolabile cerniera 240mm
FG 59SR/180: pinza universale -180mm
FG 61SR/160: pinza becchi mezzotondi -160mm
FG 63SR/160: tronchese taglienti diagonali -160mm
FG 49/HE250: forbice multiuso mod. pesante 250mm
FG 69/CJ250: pinza autobloccante 250mm
FG 35/B4: chiave a rullino mm250
FG 132/500: martello tedesco con manico in resina -500gr
FG 49: forbice per elettricista
FG 44/MT5: flessometro in nylon 5mx25mm
FG 80/8AP: lima piatta taglio mezzodolce 200mm
FG 80/8AQ: lima quadra taglio mezzodolce 200mm
FG 81/MS: matita x falegname
FG 48/L: cutter professionale a lama lunga
FG 79/SP3: spazzola fili rigidi in acciaio
FG 139/C: set 10 chiavi maschio a L esagonale lungo
FG 85/S31: set 31 inserti + adattatore porta inserti
FG 94/300: livella magnetica 300mm
FG 88/P14: giravite porta inserti 1/4"

ASSORTIMENTO 47 UTENSILI PER MANUTENZIONE GENERALE



CODICE	Contenuto	€/PZ
FG 118/AS47	47 pz	488,00

FG 602/SP9: set 9 chiavi a doppia forchetta 6x7-21x23mm
FG 22/3x75: giravite a taglio 3x75mm
FG 22/4x100: giravite a taglio 4x100mm
FG 22/5.5x100: giravite a taglio 5.5x100mm
FG 22/6.5x150: giravite a taglio 6.5x150mm
FG 22/PH0x60: giravite a croce PH0x60
FG 22/PH1x80: giravite a croce PH1x80
FG 22/PH2x100: giravite a croce PH2x100
FG 58/B240: pinza regolabile cerniera 240mm
FG 59SR/180: pinza universale -180mm
FG 61SR/160: pinza becchi mezzotondi -160mm
FG 63SR/160: tronchese taglienti diagonali -160mm
FG 49/HE300: forbice multiuso mod. pesante 300mm
FG 132/500: martello tedesco con manico in resina -500gr
FG 49: forbice per elettricista
FG 35/B4: chiave a rullino mm250
FG 44/MT5: flessometro in nylon 5mx25mm
FG 80/8AM: lima mezzotonda mezzodolce 200mm
FG 48/L: cutter professionale a lama lunga
FG 79/SP3: spazzola fili rigidi in acciaio
FG 139/C: set 10 chiavi maschio a L esagonale lungo
FG 85/S31: set 31 inserti + adattatore porta inserti





 **FASANO**
TOOLS

15

CARRELLI E BANCHI DA LAVORO



FG 100



RAL 7021

RAL 5002

RAL 6018

RAL 9016

RAL 3001

MADE IN ITALY



DISPONIBILE IN
5 VARIANTI COLORE

Gamma FG 100



MADE IN ITALY

CARATTERISTICHE TECNICHE:

- Guide telescopiche con sistema di aggancio automatico
- 4 ruote in gomma vulcanizzata Ø125mm (2 fisse e 2 girevoli)
- Chiusura laterale centralizzata
- Ripiano superiore in ABS e griglie porta utensili laterali
- Porta flapconi laterale di serie
- Pannelli laterali con fori per appendimento ganci porta utensili
- 5 cassetti 580x398x75mm e 2 cassetti 580x398x135mm

CASSETTI CON SISTEMA DI APERTURA TOTALE

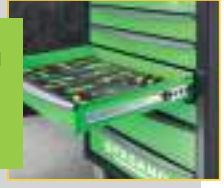

RIPIANO SUPERIORE IN ABS RIGIDO



SISTEMA DI CHIUSURA LATERALE

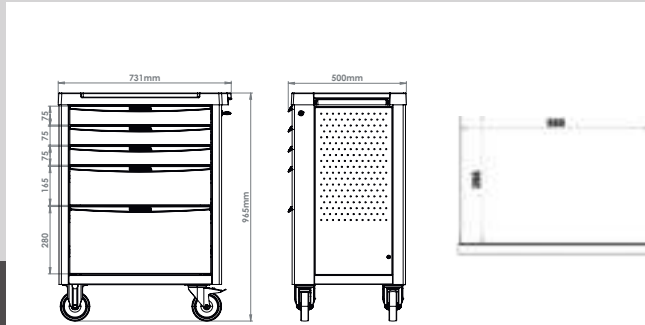

CARRELLO PORTA UTENSILI A 5 CASSETTI MOD. FG 100

CODICE	RAL	Portata kg	N. cassetti	€/PZ
FG 100V/5T	6018	800	5	1.000,00
FG 100B/5T	5002	800	5	1.000,00
FG 100R/5T	3001	800	5	1.000,00
FG 100D/5T	7021	800	5	1.000,00
FG 100W/5T	9016	800	5	1.000,00



CARRELLO PORTA UTENSILI A 6 CASSETTI MOD. FG 100

CODICE	RAL	Portata kg	N. cassetti	€/PZ
FG 100V/6T	6018	800	6	1.050,00
FG 100B/6T	5002	800	6	1.050,00
FG 100R/6T	3001	800	6	1.050,00
FG 100D/6T	7021	800	6	1.050,00
FG 100W/6T	9016	800	6	1.050,00



CARRELLO PORTA UTENSILI A 7 CASSETTI MOD. FG 100

CODICE	RAL	Portata kg	N. cassetti	€/PZ
FG 100V/7T	6018	800	7	1.100,00
FG 100B/7T	5002	800	7	1.100,00
FG 100R/7T	3001	800	7	1.100,00
FG 100D/7T	7021	800	7	1.100,00
FG 100W/7T	9016	800	7	1.100,00

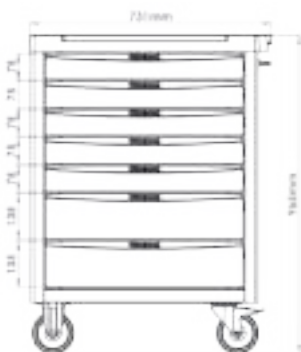

NEW

**DUE COLORI,
ANCORA PIÙ CARATTERE
PER IL TUO CARRELLO
PORTA UTENSILI
CHE ORA PUOI
PERSONALIZZARE IN BASE
AL TUO STILE.**



TOP IN ABS
CON MANIGLIONE
INTEGRATO



DOPPIA LAMIERA
DUE ABBINAMENTI
DI COLORE



GUIDE TELESCOPICHE
CON APERTURA TOTALE
DEL CASSETTO

MADE IN ITALY

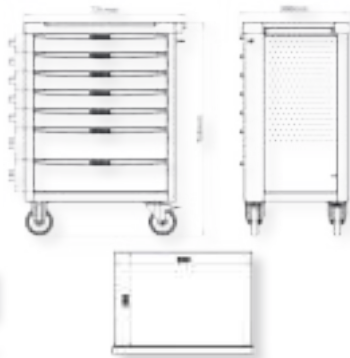

CARRELLO PORTA UTENSILI BICOLOR A 7 CASSETTI MOD. FG 100

NEW

CODICE	RAL	Portata kg	N. cassetti	€/PZ
FG 100VD/7T	6018+7021	800	7	1.350,00
FG 100VW/7T	6018+9016	800	7	1.350,00
FG 100BW/7T	5002+9016	800	7	1.350,00
FG 100BD/7T	5002+7021	800	7	1.350,00
FG 100RD/7T	3001+7021	800	7	1.350,00
FG 100RY/7T	3001+1018	800	7	1.350,00
FG 100CW/7T	5012+9016	800	7	1.350,00
FG 100MA/7T	3004+9016	800	7	1.350,00
FG 100RW/7T	3001+9016	800	7	1.350,00
FG 100RB/7T	3001+5002	800	7	1.350,00
FG 100DP/7T	7021+3015	800	7	1.350,00
FG 100DW/7T	7021+9016	800	7	1.350,00
FG 100BY/7T	5002+1018	800	7	1.350,00
FG 100GW/7T	3004+9016	800	7	1.350,00

DISPONIBILE IN

14
VARIANTI
COLORE

**COLORA IL TUO
SPAZIO DI LAVORO
CON IL CARRELLO
FG 100 NELLA SUA
NUOVA VESTE**



FG 100VW/7T



FG 100VD/7T



FG 100BW/7T



FG 100BD/7T



FG 100RD/7T



FG 100RY/7T



FG 100CW/7T



FG 100MA/7T



FG 100RW/7T



FG 100RB/7T



FG 100DP/7T



FG 100DW/7T



FG 100BY/7T



FG 100GW/7T

I nostri carrelli sono frutto di un intenso lavoro di ricerca, sviluppo, progettazione e produzione interna.

MADE IN ITALY



Gamma FG 102



MADE IN ITALY

CARATTERISTICHE TECNICHE:

- Guide telescopiche con sistema di aggancio automatico
- 4 ruote in gomma vulcanizzata Ø125mm (2 fisse e 2 girevoli)
- Maniglione in acciaio INOX
- Chiusura centralizzata
- Cassetti dotati di tappetino interno in gomma
- Portata cassetti modello FG 102: 45Kg

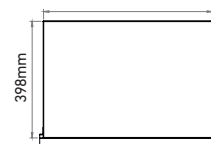
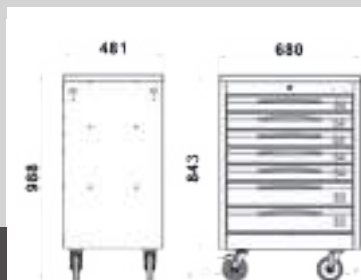

DIMENSIONI CASSETTO FG 102

FG 102/AR:
Sistema anti-ribaltamento
(su richiesta): 120,00€

TOP
IN GOMMA

MANIGLIONE
IN ACCIAIO
INOX

CHIUSURA
CENTRALIZZATA

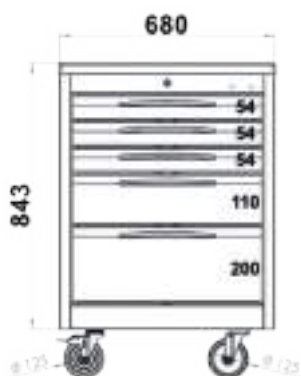

CARRELLO PORTA UTENSILI A 5 CASSETTI MOD. FG 102

CODICE	RAL	Portata kg	N. cassetti	€/PZ
FG 102D/5G	7021	800	5	960,00
FG 102B/5G	5002	800	5	960,00
FG 102R/5G	3001	800	5	960,00
FG 102V/5G	6018	800	5	960,00



FG 102D/5G



FG 102B/5G



FG 102R/5G



FG 102V/5G

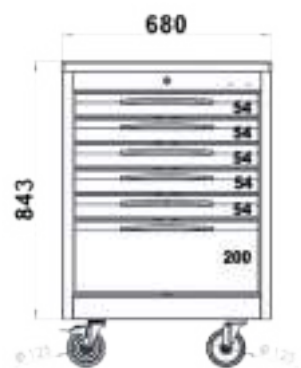

CARRELLO PORTA UTENSILI A 6 CASSETTI MOD. FG 102

CODICE	RAL	Portata kg	N. cassetti	€/PZ
FG 102D/6G	7021	800	6	1.030,00
FG 102B/6G	5002	800	6	1.030,00
FG 102R/6G	3001	800	6	1.030,00
FG 102V/6G	6018	800	6	1.030,00



FG 102D/6G



FG 102B/6G



FG 102R/6G



FG 102V/6G

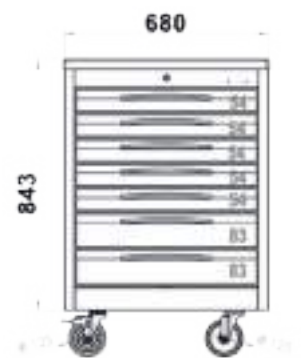

CARRELLO PORTA UTENSILI A 7 CASSETTI MOD. FG 102

CODICE	RAL	Portata kg	N. cassetti	€/PZ
FG 102D/7G	7021	800	7	1.100,00
FG 102B/7G	5002	800	7	1.100,00
FG 102R/7G	3001	800	7	1.100,00
FG 102V/7G	6018	800	7	1.100,00



FG 102D/7G



FG 102B/7G



FG 102R/7G



FG 102V/7G



CARRELLO PORTA UTENSILI A 8 CASSETTI MOD. FG 102

CODICE	RAL	Portata kg	N. cassetti	€/PZ
FG 102D/8G	7021	800	8	1.150,00
FG 102B/8G	5002	800	8	1.150,00
FG 102R/8G	3001	800	8	1.150,00
FG 102V/8G	6018	800	8	1.150,00



FG 102D/8G



FG 102B/8G



FG 102R/8G



FG 102V/8G



Gamma FG 104

CARATTERISTICHE TECNICHE:

- Guide telescopiche con sistema di aggancio automatico
- 4 ruote in gomma vulcanizzata Ø125mm (2 fisse e 2 girevoli)
- Maniglione in acciaio INOX
- Chiusura centralizzata
- Cassetti dotati di tappetino interno in gomma
- Portata cassetti modello FG 104: 60Kg



MADE IN ITALY

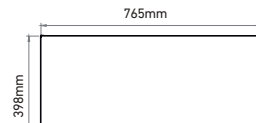
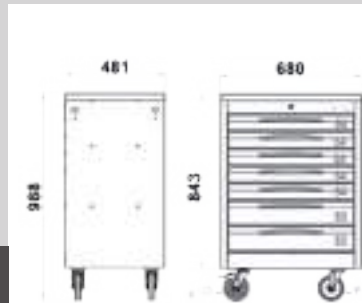

DIMENSIONI CASSETTO FG 104

FG 104/AR:
Sistema anti-ribaltamento
(su richiesta): 120,00€

TOP
IN GOMMA

MANIGLIONE
IN ACCIAIO
INOX

CHIUSURA
CENTRALIZZATA

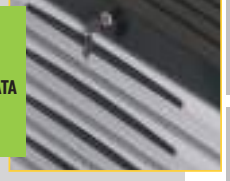

CARRELLO PORTA UTENSILI A 6 CASSETTI MOD. FG 104

CODICE	RAL	Portata kg	N. cassetti	€/PZ
FG 104D/6G	7021	800	6	1.250,00
FG 104B/6G	5002	800	6	1.250,00
FG 104R/6G	3001	800	6	1.250,00
FG 104V/6G	6018	800	6	1.250,00



FG 104D/6G



FG 104B/6G



FG 104R/6G



FG 104V/6G

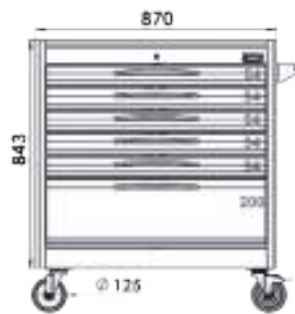

CARRELLO PORTA UTENSILI A 7 CASSETTI MOD. FG 104

CODICE	RAL	Portata kg	N. cassetti	€/PZ
FG 104D/7G	7021	800	7	1.350,00
FG 104B/7G	5002	800	7	1.350,00
FG 104R/7G	3001	800	7	1.350,00
FG 104V/7G	6018	800	7	1.350,00



FG 104D/7G



FG 104B/7G



FG 104R/7G



FG 104V/7G

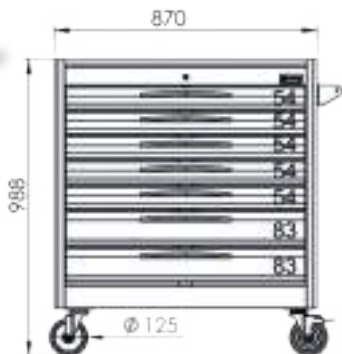

Gamma FG 101



CARATTERISTICHE TECNICHE:

- Guide telescopiche con sistema di aggancio automatico
- 4 ruote in gomma vulcanizzata Ø125mm (2 fisse e 2 girevoli)
- Maniglione laterale in acciaio
- Chiusura centralizzata
- Cassetti dotati di tappetino interno in gomma
- Portata cassetti modello FG 101: 35Kg

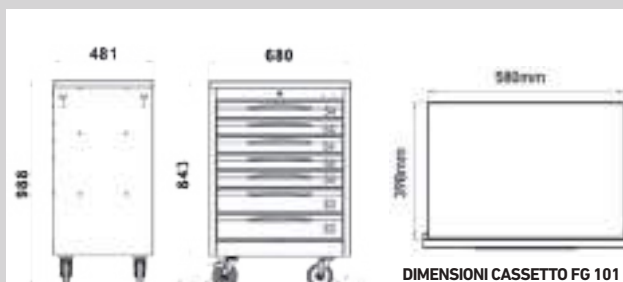

TOP
IN GOMMA



MANIGLIONE
IN ACCIAIO



SISTEMA
DI APERTURA
A BAIONETTA

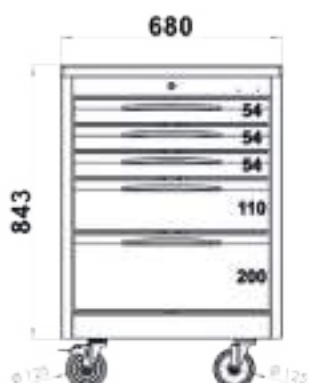
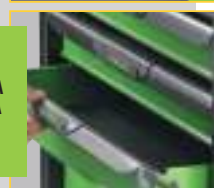

CARRELLO PORTA UTENSILI A 5 CASSETTI MOD. FG 101

CODICE	RAL	Portata kg	N. cassetti	€/PZ
FG 101V/5G	6018	500	5	680,00

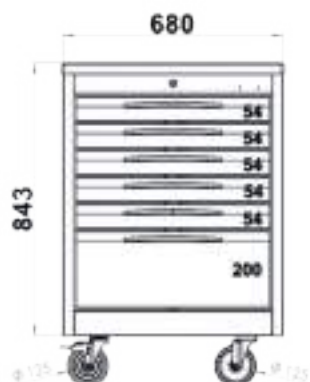

CARRELLO PORTA UTENSILI A 6 CASSETTI MOD. FG 101

CODICE	RAL	Portata kg	N. cassetti	€/PZ
FG 101V/6G	6018	500	6	710,00

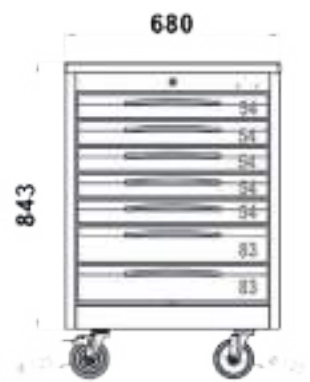

CARRELLO PORTA UTENSILI A 7 CASSETTI MOD. FG 101

CODICE	RAL	Portata kg	N. cassetti	€/PZ
FG 101V/7G	6018	500	7	750,00

CARRELLO PORTA UTENSILI A 3 CASSETTI MOD. FG 101

Ripiano superiore/inferiore porta oggetti (680x440 mm)
 Struttura in lamiera d'acciaio verniciata
 Portata cassette modello: 20Kg
 Portata ripiano superiore/inferiore: 35Kg
 Sistema di apertura a baionetta
 Maniglione in acciaio
 Possibilità di inserimento moduli utensileria



CODICE	Dimensioni mm (LxPxH)	Peso kg	N. cassette	€/PZ
FG 101V/3G	770x450x940	26,5	3	500,00



CARRELLO MULTI-SERVIZIO UNIVERSALE PER MINUTERIE E ATTREZZI DA LAVORO

Struttura laterale in alluminio e ripiani e accessori in ABS
 3 ripiani in ABS dotati di divisori amovibili
 Portata ripiano superiore: 10Kg uniformemente distribuiti
 Portata ripiano inferiore: 20Kg uniformemente distribuiti
 4 Ruote Ø 76mm (2 girevoli con freno e 2 girevoli senza)
 Dotato di 16 vaschette amovibili porta minuterie
 Divisori amovibili su ognuno dei 3 ripiani



CODICE	Dimensioni mm (LxPxH)	Peso kg	€/PZ
FG 108/B	650x465x885	3,94	180,00



CASSETTIERA PORTATILE CON 6 CASSETTI

Ripiano superiore ad apertura con pistoni a gas (650x300x65mm)
 3 cassette 268x165x35mm
 3 cassette 560x270x35mm
 Serratura frontale centralizzata
 Maniglie laterali per il trasporto

CODICE	Dimensioni mm (LxPxH)	€/PZ
FG 110	660x305x380	380,00



Gamma FG 105



MADE IN ITALY

CARATTERISTICHE TECNICHE:

- Guide telescopiche con sistema di aggancio automatico
- 4 ruote in gomma vulcanizzata Ø125mm (2 fisse e 2 girevoli)
- Maniglione laterale in acciaio
- Chiusura centralizzata
- Cassetti dotati di tappetino interno in gomma
- Appendice laterale



DIMENSIONI CASSETTO FG 105

ANTINA
APRIBILE A 90°
+ SERRATURA
CON CHIAVE



DOBPIO TOP
IN GOMMA



RIPIANI INTERNI
AMOVIBILI E
REGOLABILI

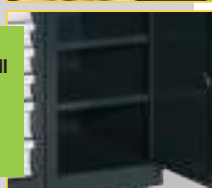

CARRELLO PORTA UTENSILI CON APPENDICE LATERALE

CODICE	RAL	Portata kg	N. cassetti	€/PZ
FG 105D/5G	7021	800	5	1.300,00
FG 105B/5G	5002	800	5	1.300,00
FG 105R/5G	3001	800	5	1.300,00
FG 105V/5G	6018	800	5	1.300,00



FG 105D/5G



FG 105B/5G



FG 105R/5G



FG 105V/5G



CARRELLO PORTA UTENSILI CON APPENDICE LATERALE

CODICE	RAL	Portata kg	N. cassetti	€/PZ
FG 105D/6G	7021	800	6	1.400,00
FG 105B/6G	5002	800	6	1.400,00
FG 105R/6G	3001	800	6	1.400,00
FG 105V/6G	6018	800	6	1.400,00



FG 105D/6G



FG 105B/6G



FG 105R/6G



FG 105V/6G



CARRELLO PORTA UTENSILI CON APPENDICE LATERALE

CODICE	RAL	Portata kg	N. cassetti	€/PZ
FG 105D/7G	7021	800	7	1.450,00
FG 105B/7G	5002	800	7	1.450,00
FG 105R/7G	3001	800	7	1.450,00
FG 105V/7G	6018	800	7	1.450,00



FG 105D/7G



FG 105B/7G



FG 105R/7G



FG 105V/7G

Gamma FG 109

CARATTERISTICHE TECNICHE:

- Guide telescopiche con sistema di aggancio automatico
- 4 ruote in gomma vulcanizzata Ø125mm (2 fisse e 2 girevoli)
- Maniglione laterale in acciaio
- Chiusura centralizzata
- Cassetti dotati di tappetino interno in gomma
- Appendice laterale

ANTINA
APRIBILE A 90°
+ SERRATURA
CON CHIAVE

DOPPIO TOP
IN GOMMA

RIPIANI INTERNI
AMOVIBILI E
REGOLABILI

MADE IN ITALY

CARRELLO PORTA UTENSILI CON APPENDICE LATERALE

CODICE	RAL	Portata kg	N. cassetti	€/PZ
FG 109D/6G	7021	800	6	1.600,00
FG 109B/6G	5002	800	6	1.600,00
FG 109R/6G	3001	800	6	1.600,00



FG 109D/6G



FG 109B/6G



FG 109R/6G



CARRELLO PORTA UTENSILI CON APPENDICE LATERALE

CODICE	RAL	Portata kg	N. cassetti	€/PZ
FG 109D/7G	7021	800	7	1.650,00
FG 109B/7G	5002	800	7	1.650,00
FG 109R/7G	3001	800	7	1.650,00



FG 109D/7G



FG 109B/7G



FG 109R/7G



Gamma FG 150



MADE IN ITALY

CARATTERISTICHE TECNICHE:

- Guide telescopiche con sistema di aggancio automatico
- 4 ruote in gomma vulcanizzata Ø125mm (2 fisse e 2 girevoli)
- Maniglione laterale in acciaio INOX
- Chiusura centralizzata
- Cassetti dotati di tappetino interno in gomma
- Portata cassetti modello FG 150: 30 Kg

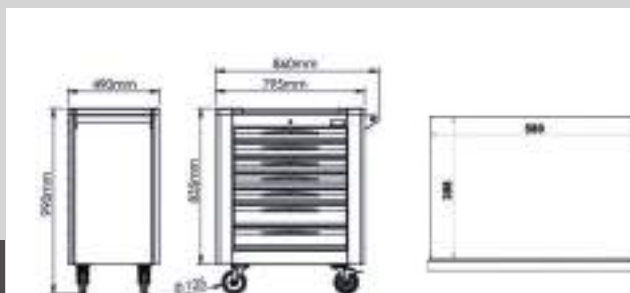

TOP
IN GOMMA

MANIGLIONE
IN ACCIAIO
INOX

CHIUSURA
CENTRALIZZATA



CARRELLO PORTA UTENSILI A 5 CASSETTI MOD. FG 150

CODICE	RAL	Portata kg	N. cassetti	€/PZ
FG 150D/5G	7021	800	5	1.000,00
FG 150R/5G	3001	800	5	1.000,00



CARRELLO PORTA UTENSILI A 6 CASSETTI MOD. FG 150

CODICE	RAL	Portata kg	N. cassetti	€/PZ
FG 150D/6G	7021	800	6	1.050,00
FG 150R/6G	3001	800	6	1.050,00

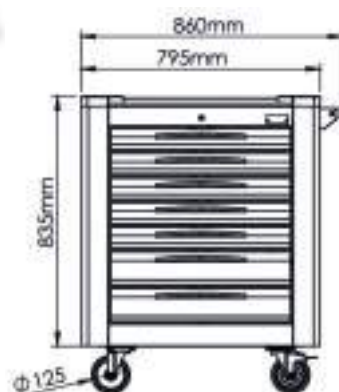

CARRELLO PORTA UTENSILI A 7 CASSETTI MOD. FG 150

CODICE	RAL	Portata kg	N. cassetti	€/PZ
FG 150D/7G	7021	800	7	1.100,00
FG 150R/7G	3001	800	7	1.100,00



Gamma FG 160



MADE IN ITALY

CARATTERISTICHE TECNICHE:

- Guide telescopiche con sistema di aggancio automatico
- 4 ruote in gomma vulcanizzata Ø160mm (2 fisse e 2 girevoli)
- Maniglione laterale in acciaio INOX
- Chiusura centralizzata
- Cassetti dotati di tappetino interno in gomma

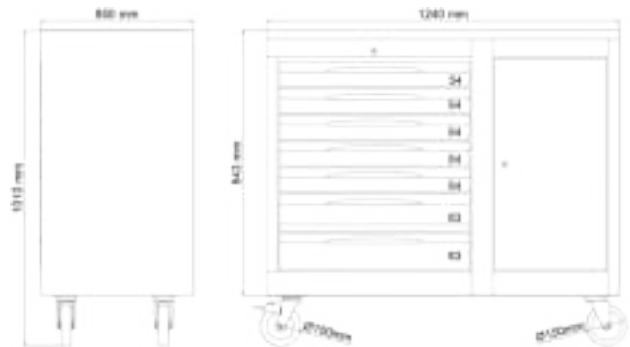

ANTINA APRIBILE A 90°, DOTATA DI SERRATURA CON CHIAVE

2 RIPIANI INTERNI AMOVIBILI



POSSIBILITÀ DI APPLICARE DIVERSI ACCESSORI LATERALI



**LARGA GRIGLIA LATERALE PORTA UTENSILI
DIMENSIONI:
665X595mm**



**7 CASSETTI PORTA MINUTERIA
PROFONDITÀ:
580X235mm**



CARRELLO PORTA UTENSILI A 14 CASSETTI MOD. FG 160

CODICE	RAL	Portata kg	N. cassetti	€/PZ
FG 160V/14L	6018	2400	14	3.550,00
FG 160B/14L	5002	2400	14	3.550,00
FG 160R/14L	3001	2400	14	3.550,00
FG 160D/14L	7021	2400	14	3.550,00



FG 160V/14L

FG 160B/14L

FG 160R/14L

FG 160D/14L



MODULO 14 CHIAVI COMBinate IN MM

FG 600/B6,7,8,9,10,11,12,13,14,15,16,17,18,19mm



1/3

CODICE	Dimensioni mm	€/PZ
FG 100/03G	398x189	160,00
FG TER 100/03G		24,00

MODULO 18 CHIAVI COMBinate IN MM

FG 600/B6,7,8,10,11,12,13,14,16,17,18,19,21,22,24,27,30,32mm



2/3

CODICE	Dimensioni mm	€/PZ
FG 100/03H	398x377	295,00
FG TER 100/03H		48,00

MODULO 6 CHIAVI COMBinate IN MM

FG 600/B21,22,24,27,30,32mm



1/3

CODICE	Dimensioni mm	€/PZ
FG 100/03L	398x189	158,00
FG TER 100/03L		24,00

MODULO 8 CHIAVI DOPPIA FORCHETTA

FG 602/B6x7,8x9,10x11,12x13,14x15,16x17,18x19,20x22 mm + FG 139C/FS



1/3

CODICE	Dimensioni mm	€/PZ
FG 100/03E	398x189	95,00
FG TER 100/03E		24,00

MODULO 5 CHIAVI DOPPIA FORCHETTA

FG 602/B21x23,24x26,25x28,27x29,30x32 mm



1/3

CODICE	Dimensioni mm	€/PZ
FG 100/03F	398x189	105,00
FG TER 100/03F		24,00

MODULO 4 CHIAVI DOPPIE POLIGONALI

FG 600/E6xE8,E10xE12,E14xE18,E20xE24



1/6

CODICE	Dimensioni mm	€/PZ
FG 100/03TX	189x199	60,00
FG TER 100/03TX		15,00

MODULO 7 CHIAVI DOPPIE POLIGONALI

FG 615/B6x7,8x9,10x11,12x13,14x15,16x17,18x19mm

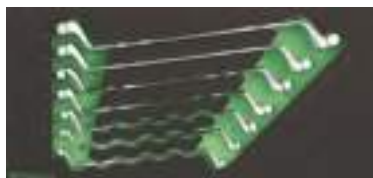

1/3

CODICE	Dimensioni mm	€/PZ
FG 100/07C	398x189	109,60
FG TER 100/07C		24,00

MODULO 5 CHIAVI DOPPIE POLIGONALI

FG 615/B20x22,21x23,24x27,25x28,30x32mm



1/3

CODICE	Dimensioni mm	€/PZ
FG 100/07D	398x189	155,00
FG TER 100/07D		24,00

MODULO 8 CHIAVI A CRICCHETTO

FG 605/B8,10,11,12,13,14,15,16,17,18,19mm



1/3

CODICE	Dimensioni mm	€/PZ
FG 100/08C	398x189	245,00
FG TER 100/08C		24,00

MODULO 8 CHIAVI A T SNODATE

FG 618/A7,8,10,11,13,14,17,19 mm

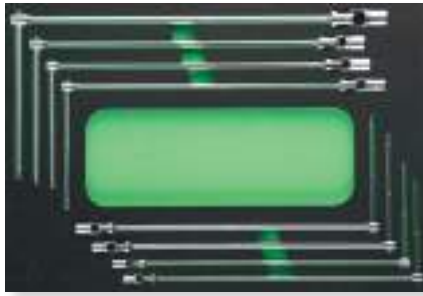

1/1

CODICE	Dimensioni mm	€/PZ
FG 100/10C	398x566	377,50
FG TER 100/10C		70,00

MODULO 12 CHIAVI A T SNODATE

FG 618/A7, 8,10,11,12,13,14,15,16,17,18,19 mm

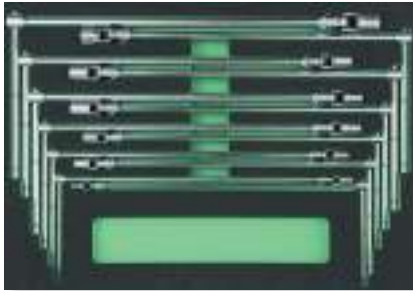

1/1

CODICE	Dimensioni mm	€/PZ
FG 100/10D	398x566	549,00
FG TER 100/10D		70,00

MODULO 6 CHIAVI A T MASCHIO ESAGONALI

FG 619/H3, 4,5,6,8,10 mm

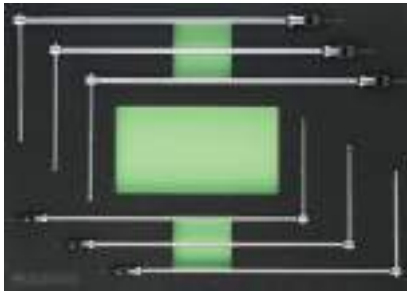

1/1

CODICE	Dimensioni mm	€/PZ
FG 100/10H	398x566	307,50
FG TER 100/10H		70,00

MODULO 8 CHIAVI A T MASCHIO TORX

FG 619/TX20,25,27,30,40,45,50,55

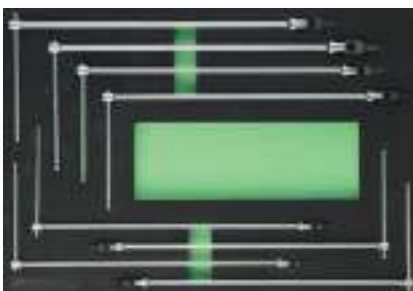

1/1

CODICE	Dimensioni mm	€/PZ
FG 100/10TX	398x566	418,50
FG TER 100/10TX		70,00

MODULO 10 CHIAVI A PIPA 6X12PT

FG 613/A6,7,8,10,11,12,13,14,17,19mm



1/3

CODICE	Dimensioni mm	€/PZ
FG 100/13C	398x189	202,90
FG TER 100/13C		24,00

MODULO 8 CHIAVI A TUBO MOD. PESANTE

FG 614/A6x7,8x9,10x11,12x13,14x15,16x17,18x19,20x22

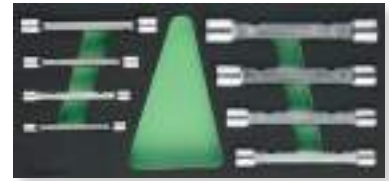

1/3

CODICE	Dimensioni mm	€/PZ
FG 100/12B	398x189	178,60
FG TER 100/12B		24,00

MODULO CHIAVI A BUSSOLA ESAGONALI



1/3

1/4"

CODICE	Dimensioni mm	€/PZ
FG 100/17	398x189	142,00
FG TER 100/17		24,00

CONTENUTO

	FG 624/E	4,5,6,7,8,9,10,11,12,13,14mm
	FG 624/CR14	
	FG 624/ES14	
	FG 624/PA	50, 100
	FG 624/PRF150	
	FG 624/GR14C	
	FG 624/SN14	

MODULO 9 CHIAVI COMBINATE - POLLICI

FG 600/IN1/4", 5/16", 3/8", 7/16", 1/2", 9/16", 5/8", 11/16", 3/4"



1/3

CODICE	Dimensioni mm	€/PZ
FG 100/03IN	398x189	122,50
FG TER 100/03IN		24,00



MODULO CHIAVI A BUSSOLA ESAGONALI



1/3

1/4"

CODICE	Dimensioni mm	€/PZ
FG 100/17E	398x189	285,00
FG TER 100/17E		24,00

CONTENUTO

	FG 624/E	4,5,6,7,8,9,10,11,12,13,14mm
	FG 624/CR14	
	FG 624/ES14	
	FG 624/PA	50, 100
	FG 624/PRF150	
	FG 624/GR14C	
	FG 624/SN14	
	FG 147	
	FG 139/L	H1.5-10, PH1-4, TX8-40, SL1-5

MODULO CHIAVI A BUSSOLA ESAGONALI



1/3

3/8"

CODICE	Dimensioni mm	€/PZ
FG 100/18	398x189	295,00
FG TER 100/18		24,00

CONTENUTO

	FG 624B/L	8,9,10,11,12,13,14,15,16,17,18,19, 21,22,23mm
	FG 624/CR38	
	FG 624B/PA	75,125,150,250mm
	FG 624/ES38	
	FG 624/SN38	

MODULO CHIAVI A BUSSOLA ESAGONALI



1/3

1/4"

CODICE	Dimensioni mm	€/PZ
FG 100/17IN	398x189	167,20
FG TER 100/17IN		24,00

CONTENUTO

	FG 624/E	5/32, 3/16, 7/32, 1/4, 9/32, 5/16, 11/32, 3/8, 7/16, 15/32, 1/2, 9/16
	FG 624/CR14	
	FG 624/ES14	
	FG 624/PA	50, 100
	FG 624/PRF150	
	FG 624/GR14C	
	FG 624/SN14	

MODULO CHIAVI A BUSSOLA ESAGONALI



1/3

3/8"

CODICE	Dimensioni mm	€/PZ
FG 100/19	398x189	230,00
FG TER 100/19		24,00

CONTENUTO

	FG 624/B	8,9,10,11,12,13,14,15,16,17,18,19, 21,22,23mm
	FG 624/CR38	
	FG 624B/PA	75,125,150,250mm
	FG 624/ES38	
	FG 624/SN38	

MODULO CHIAVI A BUSSOLA ESAGONALI



1/3

3/8"

CODICE	Dimensioni mm	€/PZ
FG 100/19IN	398x189	230,00
FG TER 100/19IN		24,00

CONTENUTO

	FG 624/B	1/4", 5/16", 11/32", 3/8", 7/16", 15/32", 1/2", 9/16", 19/32", 5/8", 11/16", 3/4", 25/3", 13/16", 7/8", 15/16"
	FG 624/CR38	
	FG 624B/PA	75,125,150,250mm
	FG 624/ES38	
	FG 624/SN38	

MODULO CHIAVI A BUSSOLA POLIGONALI



1/3

3/8"

CODICE	Dimensioni mm	€/PZ
FG 100/18B	398x189	260,00
FG TER 100/18B		24,00

CONTENUTO

	FG 624/L	8,9,10,11,12,13,14,15,16,17,18, 19mm
	FG 624/CR38	
	FG 624B/PA	75,125,150,250
	FG 624/ES38	
	FG 624/SN38	

MODULO CHIAVI A BUSSOLA POLIGONALI



1/3

3/8"

CODICE	Dimensioni mm	€/PZ
FG 100/19B	398x189	210,00
FG TER 100/19B		24,00

CONTENUTO

	FG 624/C	8,9,10,11,12,13,14,15,16,17,18,1 9, 21mm
	FG 624/CR38	
	FG 624B/PA	75,125,150,250
	FG 624/ES38	
	FG 624/SN38	

MODULO CHIAVI A BUSSOLA ESAGONALI



1/3

1/2"

CODICE	Dimensioni mm	€/PZ
FG 100/21B	398x189	245,00
FG TER 100/21B		24,00

CONTENUTO

	FG 625/A	10,11,12,13,14,15,16,17,18,19,20,2 1,22,23,24,25,26,27,30,32
	FG 625/CR12	
	FG 625/SN12	
	FG 625/ES12	
	FG 625/PA	125,250



MODULO CHIAVI A BUSSOLA POLIGONALI



CODICE	Dimensioni mm	€/PZ
FG 100/21C	398x189	245,00
FG TER 100/21C		24,00

CONTENUTO

	FG 625/C	10,11,12,13,14,15,16,17,18,19,20,21,22,23,24,25,26,27,30,32
	FG 625/CR12	
	FG 625/SN12	
	FG 625/ES12	
	FG 625/PA	125,250

MODULO CHIAVI A BUSSOLA POLIGONALI



CODICE	Dimensioni mm	€/PZ
FG 100/21D	398x189	165,00
FG TER 100/21D		24,00

CONTENUTO

	FG 625/C	8,10,12,13,15,17,19,21,24,27,30,32
	FG 625/CR12	
	FG 625/SN12	
	FG 625/ES12	
	FG 625/PA	125,250



MODULO CHIAVI A BUSSOLA ESAGONALI



CODICE	Dimensioni mm	€/PZ
FG 100/21M	398x189	165,00
FG TER 100/21M		24,00

CONTENUTO

	FG 625/A	8,10,12,13,15,17,19,21,24,27,30,32
	FG 625/CR12	
	FG 625/SN12	
	FG 625/ES12	
	FG 625/PA	125,250

MODULO CHIAVI A BUSSOLA ESAGONALI



CODICE	Dimensioni mm	€/PZ
FG 100/21E	398x283	420,00
FG TER 100/21E		35,00

MODULO CHIAVI A BUSSOLA ESAGONALI



CODICE	Dimensioni mm	€/PZ
FG 100/21IN	398x189	260,00
FG TER 100/21IN		24,00

CONTENUTO

	FG 625/A	5/16", 3/8", 7/16", 15/32", 1/2", 9/16", 19/32", 5/8", 11/16", 3/4", 25/32", 13/16", 7/8", 15/16", 1", 1.1/16", 1.3/16", 1.1/4"
	FG 625/CR12	
	FG 625/SN12	
	FG 625/ES12	
	FG 625/PA	125,250

MODULO CHIAVI A BUSSOLA ESAGONALI



1/3 1/4" 1/2"

CODICE	Dimensioni mm	€/PZ
FG 100/21G	398x189	330,00
FG TER 100/21G		24,00

MODULO CHIAVI A BUSSOLA ESAGONALI

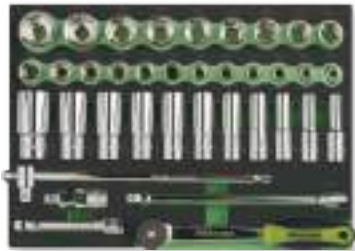

2/3 1/2"

CODICE	Dimensioni mm	€/PZ
FG 100/21H	398x283	430,00
FG TER 100/21H		35,00

CONTENUTO

	FG 625/A	8,9,10,11,12,13,14,15,16,17,18,19,20,21,22,23,24,26,27,30,32mm
	FG 625L/A	10,12,13,14,17,19,21,22,24,27,30mm
	FG 625/CR12	
	FG 625/PA	125,250
	FG 625/ES12	
	FG 625/SN12	

MODULO UTENSILI CON IMPRONTA TORX



1/3 1/4" 1/2"

CODICE	Dimensioni mm	€/PZ
FG 100/21TX	398x189	260,00
FG TER 100/21TX		24,00

CONTENUTO

	FG 624/TX	4-10
	FG 625/TX	8-24
	FG 147/TX	9-40
	FG 150/TX	10-60
	FG 138/C	

MODULO 19 CHIAVI A BUSSOLA RINFORZATE

FG 628/L10, 11, 12, 13, 14, 15, 16, 17, 18, 19, 21, 22, 23, 24, 25, 27, 29, 30, 32mm



1/3 1/2"

CODICE	Dimensioni mm	€/PZ
FG 100/23B	398x189	360,00
FG TER 100/23B		35,00

MODULO 20 CHIAVI A BUSSOLA RINFORZATE

FG 628/C10, 11, 12, 13, 14, 15, 16, 17, 18, 19, 21, 22, 23, 24, 25, 26, 27, 30, 32mm



1/3 1/2"

CODICE	Dimensioni mm	€/PZ
FG 100/23C	398x189	220,00
FG TER 100/23C		24,00

MODULO CHIAVI A BUSSOLA ESAGONALI



2/3 3/4"

CODICE	Dimensioni mm	€/PZ
FG 100/25	398x377	420,00
FG TER 100/25		35,00

CONTENUTO

	FG 629/A	34,36,41,46,50mm
	FG 629/CR34	
	FG 629/SN34	
	FG 629/ES34	
	FG 629/PR200	



MODULO CHIAVI A BUSSOLA POLIGONALI



2/3 **3/4"**

CODICE	Dimensioni mm	€/PZ
FG 100/25B	398x377	420,00
FG TER 100/25B		35,00

CONTENUTO

	FG 629/B	34,36,41,46,50mm
	FG 629/CR34	
	FG 629/SN34	
	FG 629/ES34	
	FG 629/PR200	

MODULO 3 PINZE ASSORTITE - SERIE INDUSTRIAL



1/3

CODICE	Dimensioni mm	€/PZ
FG 100/39XT	398x189	104,00
FG TER 100/39XT		24,00

MODULO 3 PINZE

FG 59SR/180, FG 60SR/160, FG 63SR/160



1/3

CODICE	Dimensioni mm	€/PZ
FG 100/39C	398x189	95,00
FG TER 100/39C		24,00

MODULO 4 PINZE PER ANELLI ELASTICI

FG 51/140, FG 52/140, FG 53/140, FG 54/140



1/3

CODICE	Dimensioni mm	€/PZ
FG 100/41C	398x189	110,00
FG TER 100/41C		24,00

MODULO 4 PINZE PER ANELLI ELASTICI

FG 51/180, FG 52/180, FG 53/180, FG 54/180



1/3

CODICE	Dimensioni mm	€/PZ
FG 100/42C	398x189	115,00
FG TER 100/42C		24,00

MODULO 40 INSERTI CON ATTACCO 1/4"



1/6

CODICE	Dimensioni mm	€/PZ
FG 100/48D	189x199	110,00
FG TER 100/48D		14,00

MODULO 52 INSERTI - ATTACCO 10MM

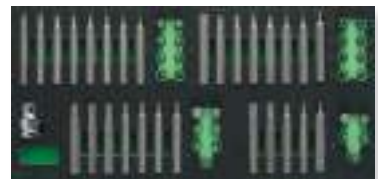

1/3    

CODICE	Dimensioni mm	€/PZ
FG 100/48G	398x189	130,00
FG TER 100/48G		24,00

MODULO 6 GIRAVITI TAGLIO E CROCE

FG 22/3x100, 4x125, 5.5x200, 6.5x150, FG 22/PH1x80, PH2x150



1/3  

CODICE	Dimensioni mm	€/PZ
FG 100/45D	398x189	65,00
FG TER 100/45D		24,00

MODULO 8 GIRAVITI TAGLIO E CROCE

3x100, 4x125, 5.5x150, 6.5x150, 6.5x38, PH1x80, PH2x150, PH2x38

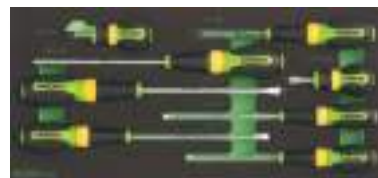

1/3  

CODICE	Dimensioni mm	€/PZ
FG 100/45E	398x189	80,00
FG TER 100/45E		24,00

MODULO 6 GIRAVITI A CROCE PHILLIPS

PH0x60, PH1x150, PH2x100, PH2x150, PH3x150, PH2x38



CODICE	Dimensioni mm	€/PZ
FG 100/45F	398x189	68,00
FG TER 100/45F		23,00

MODULO 7 GIRAVITI A TAGLIO

2.5x60, 3x100, 3.5x100, 4x125, 5.5x150, 5.5x100, 6.5x150

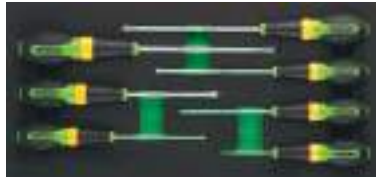

CODICE	Dimensioni mm	€/PZ
FG 100/45G	398x189	68,00
FG TER 100/45G		24,00

MODULO 6 GIRAVITI CON IMPRONTA TORX

TX10, TX15, TX20, TX25, TX27, TX30



CODICE	Dimensioni mm	€/PZ
FG 100/45I	398x189	82,00
FG TER 100/45I		24,00

MODULO 5 GIRAVITI EXTRA LUNGH

FG 22/2.5x300, 4x400, 5.5x400, FG 22/PH1x400, PH2x400

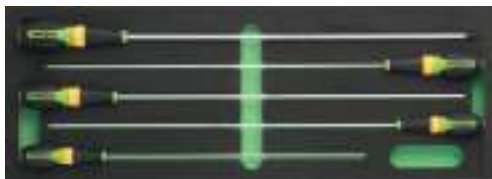

CODICE	Dimensioni mm	€/PZ
FG 100/45H	398x283	80,00
FG TER 100/45H		48,00

MODULO 6 GIRAVITI CON IMPRONTA TORX FORATA

RTX10, RTX15, RTX20, RTX25, RTX27, RTX30



CODICE	Dimensioni mm	€/PZ
FG 100/45L	398x189	84,00
FG TER 100/45L		24,00

MODULO 6 GIRAVITI A TESTA ESAGONALE

FG 22/H2.5, 3, 4, 5, 6, 8 mm



CODICE	Dimensioni mm	€/PZ
FG 100/45M	398x189	73,50
FG TER 100/45M		23,00

MODULO 5 GIRAVITI A TESTA ESAGONALE

FG 22/FL 5, 6, 7, 8, 10 mm



CODICE	Dimensioni mm	€/PZ
FG 100/45Q	398x189	132,50
FG TER 100/45Q		24,00

MODULO 5 GIRAVITI A BUSSOLA ESAGONALE

FG 22/FX6,FX7,FX8,FX10,FX13

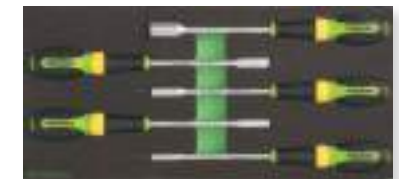

CODICE	Dimensioni mm	€/PZ
FG 100/45T	398x189	85,00
FG TER 100/45T		24,00

MODULO CHIAVI MASCHIO ESAGONALI

FG 142/2-10, FG 138

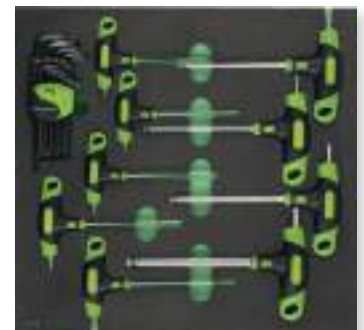

CODICE	Dimensioni mm	€/PZ
FG 100/50E	398x377	200,00
FG TER 100/50E		48,00



MODULO 6 CHIAVI MASCHIO ESAGONALI

FG 142/2, 2.5, 3, 4, 5, 6



CODICE	Dimensioni mm	€/PZ
FG 100/50F	398x189	90,00
FG TER 100/50F		24,00

MODULO 6 CHIAVI MASCHIO TORX

FG 143/TX10, TX15, TX20, TX25, TX27, TX30

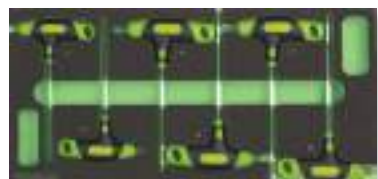

CODICE	Dimensioni mm	€/PZ
FG 100/50G	398x189	90,00
FG TER 100/50G		24,00

MODULO UTENSILI PER CARROZZERIA

FG 130/TP, FG 130/TQ, FG 130/TZQ, FG 130/TPP, FG 131/TR, FG 131/TV, FG 131/TTB



CODICE	Dimensioni mm	€/PZ
FG 100/53	398x283	310,00
FG TER 100/53		35,00

MODULO UTENSILI PER CARROZZERIA

FG 130/TP, FG 130/TQ, FG 131/TB, FG 131/TC, FG 131/TV, FG 131/SC, FG 131/SCZ, FG 131/PL12, FG 136/30



CODICE	Dimensioni mm	€/PZ
FG 100/53B	398x283	570,00
FG TER 100/53B		35,00

MODULO 7 CHIAVI MASCHIO ESAGONALI

FG 621/H2, 2.5, 3, 4, 5, 6, 8mm



CODICE	Dimensioni mm	€/PZ
FG 100/51H	398x189	145,00
FG TER 100/51H		24,00

MODULO 8 LEVAPIOLI

FG 185/A1, A2, A3, A4, A5, A6, A7, A8



CODICE	Dimensioni mm	€/PZ
FG 100/52A	398x377	184,00
FG TER 100/52A		35,00

MODULO 26 UTENSILI DA TAGLIO PER CARROZZERIA

FG 183/CM - FG 183CM/S3, FG 183/CK250 - FG 183/CK-R, FG 183/RA1 - FG 183RA/S10



CODICE	Dimensioni mm	€/PZ
FG 100/52B	398x189	166,00
FG TER 100/52B		24,00

MODULO 5 UTENSILI PER CRISTALLI VEICOLI

FG 187/IM - FG 187/W50 - FG 187/GU2 - FG 187/GR



CODICE	Dimensioni mm	€/PZ
FG 100/52C	398x189	151,00
FG TER 100/52C		24,00

MODULO 10 LEVE IN NYLON

FG 185P/S4 - FG 188/P1 - FG 186P/S5



CODICE	Dimensioni mm	€/PZ
FG 100/52D	398x189	103,00
FG TER 100/52D		24,00

MODULO 5 CUNEI IN PLASTICA

FG 188P/S2 - FG 184P/S3



1/3

CODICE	Dimensioni mm	€/PZ
FG 100/52E	398x189	89,00
FG TER 100/52E		24,00

MODULO 5 RASCHIETTI IN ACCIAIO

FG 184R/S3 - FG184/R1 - FG 184/R2



1/3

CODICE	Dimensioni mm	€/PZ
FG 100/52F	398x189	111,00
FG TER 100/52F		24,00

MODULO 5 UTENSILI CARROZZERIA

FG 185/RM - FG 185/CR - FG 189/PO1 - FG 182/RG10 - FG 183/RV1



1/3

CODICE	Dimensioni mm	€/PZ
FG 100/52G	398x189	122,00
FG TER 100/52G		24,00

MODULO UTENSILI MANUTENZIONE PER CARROZZERIA

FG 47/S3 - FG 48/L - FG 48/KL10 - FG 22XL/TX10 - FG 22XL/TX15 - FG 22XL/TX20 - FG 22XL/TX25 - FG 22XL/TX27



1/1

CODICE	Dimensioni mm	€/PZ
FG 100/52H	398x566	232,00
FG TER 100/52H		70,00

MODULO 5 LEVAPOLIPI

G 186/S5

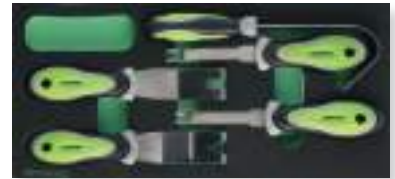

1/3

CODICE	Dimensioni mm	€/PZ
FG 100/68	398x189	122,00
FG TER 100/68		24,00

MODULO UTENSILI DA PERCUSSIONE

FG 135/45 - FG 136-40

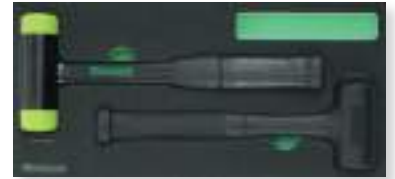

1/3

CODICE	Dimensioni mm	€/PZ
FG 100/55B	398x189	120,00
FG TER 100/55B		24,00

MODULO UTENSILI DA PERCUSSIONE

FG 132/500, FG 136/40 - FG 126/SN1, FG 126/SN3



1/3

CODICE	Dimensioni mm	€/PZ
FG 100/56C	398x189	135,00
FG TER 100/56C		24,00

MODULO 5 UTENSILI DI MISURAZIONE

FG 95/CA, FG 188/2, FG 95/M1, FG 81/PT1, FG 44/MT5



1/3

CODICE	Dimensioni mm	€/PZ
FG 100/54	398x189	170,00
FG TER 100/54		24,00

MODULO PINZE AUTOBLOCCANTI

FG 58/B240, FG 69/CJ250



1/3

CODICE	Dimensioni mm	€/PZ
FG 100/65B	398x189	92,50
FG TER 100/65B		24,00



MODULO PINZE AUTOBLOCCANTI

FG 70/CJ250 - FG 58/A240 - FG 49/HE250



CODICE	Dimensioni mm	€/PZ
FG 100/65C	398x189	131,80
FG TER 100/65C		24,00

MODULO LIME A TAGLIO MEZZODOLCE

FG 80/8AR, FG 80/8AM, FG 80/8AP, FG 80/8AT, FG 80/8AQ



CODICE	Dimensioni mm	€/PZ
FG 100/62B	398x189	98,00
FG TER 100/62B		24,00

MODULI TAPPI E CHIAVI FILTRO OLIO

FG 176/F01 - FG 176/RE - FG 175/S15



CODICE	Dimensioni mm	Contenuto	€/PZ
FG 100/76C	398x189	8,10, 12, 14, 17 mm 13, 14, 17, 18, 19, 21mm TX45	274,00
FG TER 100/76C			24,00

MODULO INSERTI A BUSSOLA

FG 150/H2-H8, FG 150L/H2-H8, FG 150/M5-M16, FG 150L/M5-M14



CODICE	Dimensioni mm	€/PZ
FG 100/81F	398x189	200,00
FG TER 100/81F		24,00

MODULO INSERTI A BUSSOLA RIBE

FG 150/R4-R14, FG 150L/R4-R14, FG 150/R4-R14, FG 150L/R4-R14



CODICE	Dimensioni mm	€/PZ
FG 100/82B	398x189	170,00
FG TER 100/82B		24,00

MODULO VUOTO PORTA MINUTERIE



CODICE	Dimensioni mm	€/PZ
FG 100/VA1	398x189	24,00

MODULO VUOTO PORTA MINUTERIE

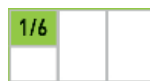

CODICE	Dimensioni mm	€/PZ
FG 100/VA2	189x199	14,00

MODULO VUOTO PORTA MINUTERIE



CODICE	Dimensioni mm	€/PZ
FG 100/VA3	398x189	24,00

MODULO VUOTO PORTA MINUTERIE



CODICE	Dimensioni mm	€/PZ
FG 100/VA4	189x199	21,00

ASSORTIMENTO 161 UTENSILI IN MODULI DI GOMMA

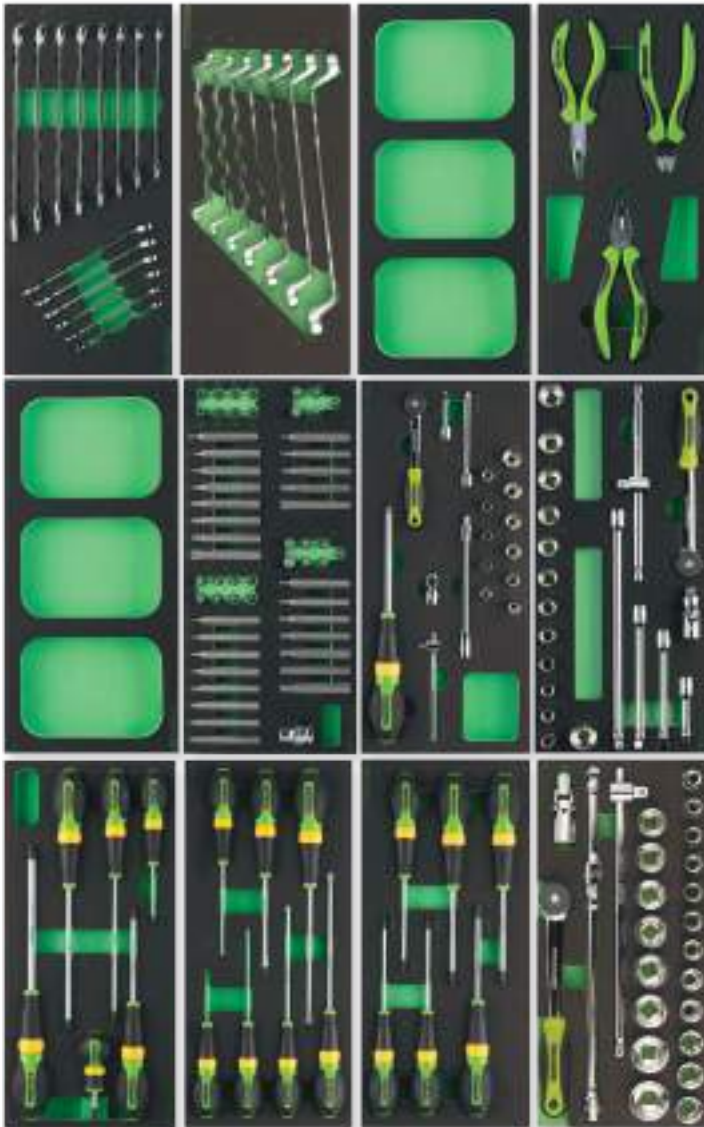

CODICE	€/PZ
FG 100/AS161	1.357,60

- FG 100/03G:** Modulo 14 chiavi combinate 6 - 19mm
- FG 100/VA1:** Modulo porta minuterie
- FG 100/07C:** Modulo 7 chiavi doppie poligonali
- FG 100/39C:** Modulo 3 pinze assortite
- FG 100/VA1:** Modulo porta minuterie
- FG 100/48G:** Modulo 52 inserti da 10mm
- FG 100/17:** Modulo 11 chiavi a bussola 1/4" esagonali + acc.
- FG 100/19:** Modulo chiavi a bussola esagonali
- FG 100/21B:** Modulo 25 utensili da 1/2"
- FG 100/45F:** Modulo 6 giraviti a croce Phillips
- FG 100/45G:** Modulo 7 giraviti a taglio
- FG 100/45I:** Modulo 6 giraviti TORX

ASSORTIMENTO 226 UTENSILI IN MODULI DI GOMMA

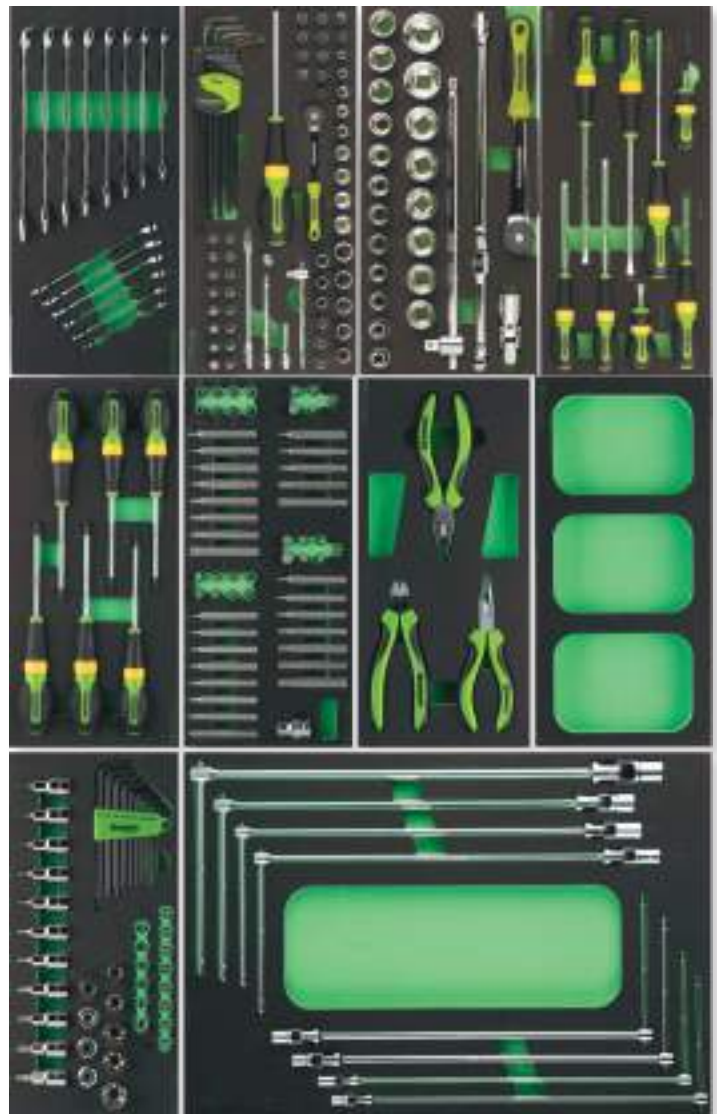

CODICE	€/PZ
FG 100/AS226	1.738,50

- FG 100/03G:** Modulo 14 chiavi combinate 6 - 19mm
- FG 100/17E:** Modulo 11 chiavi a bussola da 1/4" esagonali + accessori
- FG 100/21B:** Modulo chiavi a bussola esagonali 1/2" 8-32mm + acc.
- FG 100/45I:** Modulo 6 giraviti con impronta Torx
- FG 100/45E:** Modulo 8 giraviti a taglio e croce Phillips
- FG 100/48G:** Modulo inserti corti e lunghi con attacco 10mm
- FG 100/39C:** Modulo 3 pinze assortite
- FG 100/VA1:** Modulo porta minuterie
- FG 100/21TX:** Modulo 44 utensili TORX
- FG 100/10C:** Modulo 8 chiavi a T snodate 7-19mm



ASSORTIMENTO 173 UTENSILI IN MODULI DI GOMMA



CODICE	€/PZ
FG 100/AS173	1.953,00

- FG 100/036:** Modulo 14 chiavi combinate 6 - 19mm
- FG 100/VA1:** Modulo di riempimento con vani porta minuteria
- FG 100/03E:** Modulo 8 chiavi a forchetta + set 9 chiavi maschio esagonali
- FG 100/17:** Modulo 11 chiavi a bussola da 1/4" esagonali + acc.
- FG 100/21TX:** Modulo 44 utensili con impronta TORX
- FG 100/21B:** Modulo chiavi a bussola esagonali 1/2" 8-32mm + acc.
- FG 100/81F:** Modulo inserti a bussola da 1/2" esagonali e XZN
- FG 100/42C:** Modulo 4 pinze per anelli elastici 19-60mm
- FG 100/65B:** Modulo pinze autobloccanti e a cerniera
- FG 100/39C:** Modulo 3 pinze assortite
- FG 100/45D:** Modulo 6 giraviti ESTRO a taglio e croce PH
- FG 100/45I:** Modulo 6 giraviti con impronta TORX
- FG 100/10C:** Modulo 8 chiavi a T snodate 7-19mm

ASSORTIMENTO 230 UTENSILI IN MODULI DI GOMMA



CODICE	€/PZ
FG 100/AS230	2.311,50

- FG 100/036:** Modulo 14 chiavi combinate 6 - 19mm
- FG 100/VA1:** Modulo di riempimento con vani porta minuteria
- FG 100/03L:** Modulo 6 chiavi combinate
- FG 100/17E:** Modulo 65 utensili da 1/4"
- FG 100/21TX:** Modulo 44 utensili con impronta Torx
- FG 100/21B:** Modulo chiavi a bussola esagonali 1/2" 8-32mm + acc.
- FG 100/81F:** Modulo inserti a bussola da 1/2" esagonali e XZN
- FG 100/23C:** Modulo 14 utensili a percussione da 1/2"
- FG 100/56C:** Modulo utensili da percussione
- FG 100/39C:** Modulo 3 pinze assortite
- FG 100/45E:** Modulo 8 giraviti ad intaglio e a croce phillips
- FG 100/45I:** Modulo 6 giraviti con impronta TORX
- FG 100/10C:** Modulo 8 chiavi a T snodate esagonali

ASSORTIMENTO 248 UTENSILI IN MODULI DI GOMMA



CODICE	€/PZ
FG 100/AS248	2.747,50

- FG 100/03G:** Modulo 14 chiavi combinate 6 - 19mm
- FG 100/03L:** Modulo 6 chiavi combinate 21 - 32mm
- FG 100/VA4:** Modulo di riempimento con vani porta minuteria
- FG 100/21H:** Modulo 32 chiavi a bussola esagonali da 1/2" 8-32mm + acc
- FG 100/42C:** Modulo 4 pinze per anelli elastici 19-60mm
- FG 100/39C:** Modulo 3 pinze
- FG 100/45E:** Modulo 8 giraviti ad intaglio e a croce Phillips
- FG 100/45I:** Modulo 6 giraviti con impronta Torx
- FG 100/17E:** Modulo 65 utensili da 1/4"
- FG 100/21TX:** Modulo 44 utensili con impronta Torx
- FG 100/81F:** Modulo inserti a bussola da 1/2" esagonali e XZN
- FG 100/23C:** Modulo 20 chiavi a bussola rinforzate da 1/2"
- FG 100/65B:** Modulo pinza autobloccante e pinza regolabile a cerniera
- FG 100/10D:** Modulo 12 chiavi a T snodate esagonali

ASSORTIMENTO 360 UTENSILI IN MODULI DI GOMMA

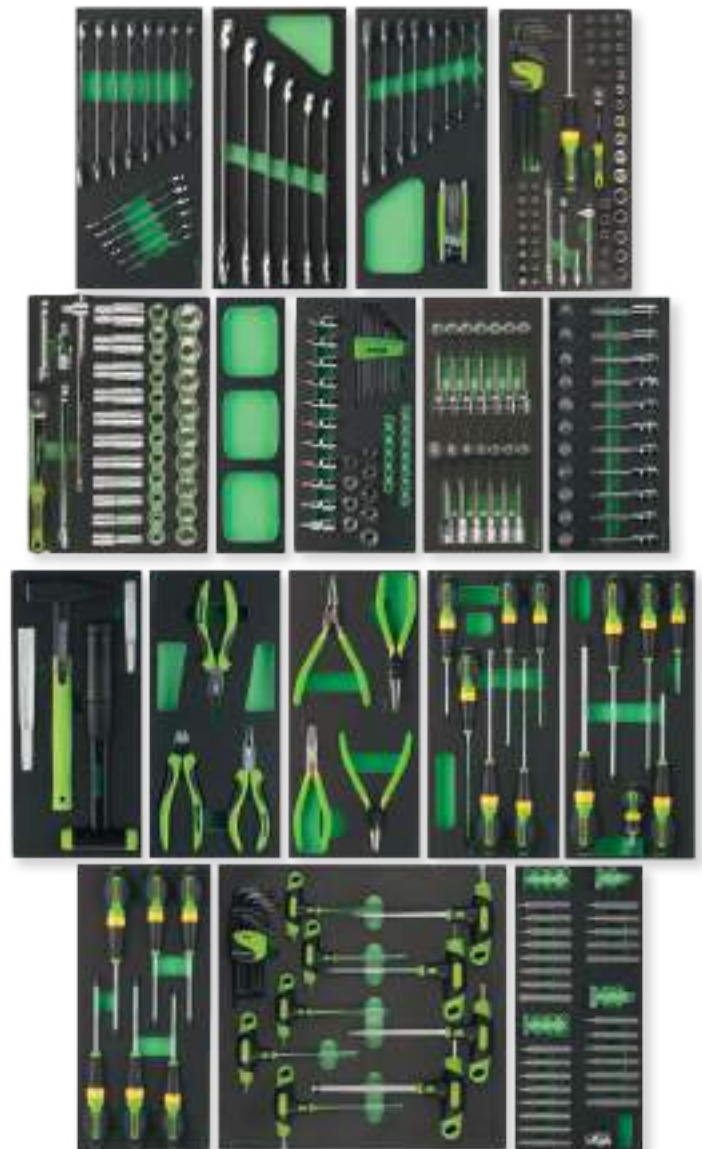

CODICE	€/PZ
FG 100/AS360	2.740,30

- FG 100/03G:** Modulo 14 chiavi combinate 6 - 19mm
- FG 100/03L:** Modulo 6 chiavi combinate 21 - 32mm
- FG 100/03E:** Modulo 8 chiavi doppia forchetta
- FG 100/17E:** Modulo utensili con attacco quadro 1/4"
- FG 100/21H:** Modulo utensili con attacco quadro 1/2"
- FG 100/VA4:** Modulo vuoto porta minuterie
- FG 100/21TX:** Modulo 44 utensili con impronta Torx
- FG 100/81F:** Modulo inserti a bussola da 1/2" esagonali e XZN
- FG 100/82B:** Modulo inserti a bussola RIBE con attacco 1/2"
- FG 100/56C:** Modulo utensili da percussione
- FG 100/39C:** Modulo 3 pinze con manici rivestiti in bi-materiale
- FG 100/42C:** Modulo 4 pinze per anelli elastici
- FG 100/45G:** Modulo 6 giraviti con testa a croce Phillips
- FG 100/45F:** Modulo 6 cacciaviti con testa a croce Phillips
- FG 100/45I:** Modulo 6 giraviti con testa con impronta torx
- FG 100/50E:** Modulo chiavi maschio esagonali e TORX
- FG 100/48G:** Modulo 52 inserti con attacco 10mm + adattatore



ASSORTIMENTO 304 UTENSILI IN MODULI DI GOMMA

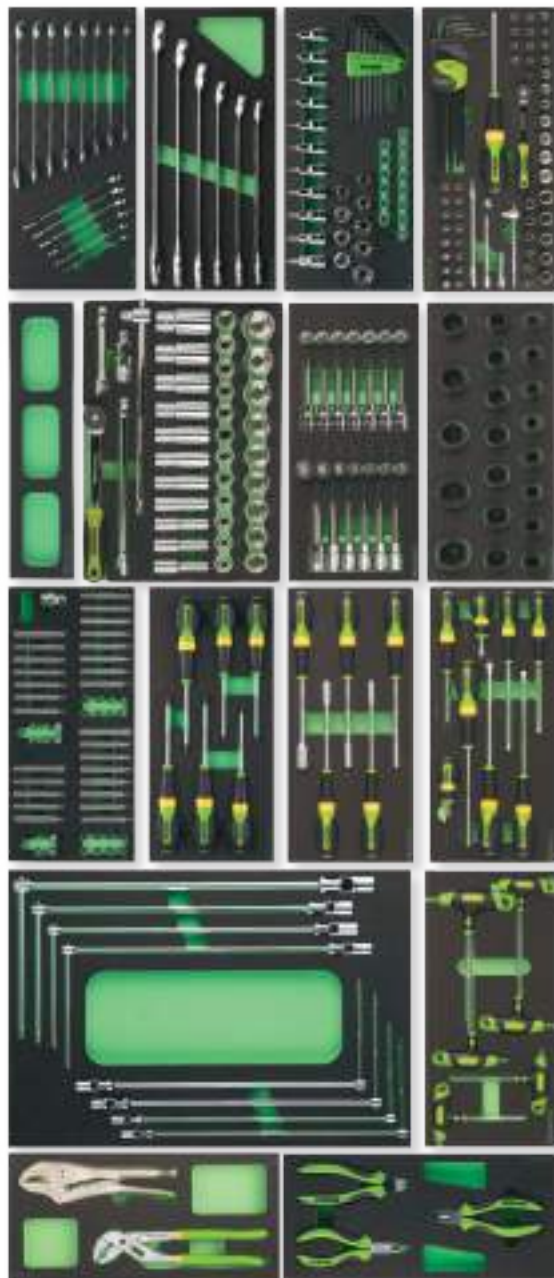

CODICE

FG 100/AS304

€/PZ

2.766,00

- FG 100/03G:** Modulo 14 chiavi combinate 6 - 19mm
- FG 100/03L:** Modulo 6 chiavi combinate 21 - 32mm
- FG 100/21H:** Modulo 32 chiavi a bussola esagonali 1/2" 8-32m + acc.
- FG 100/17E:** Modulo 65 utensili da 1/4"
- FG 100/21TX:** Modulo 44 utensili con impronta Torx
- FG 100/VA4:** Modulo di riempimento con vani porta minuteria
- FG 100/81F:** Modulo inserti a bussola da 1/2" esagonali e XZN
- FG 100/23C:** Modulo 14 utensili a percussione da 1/2"
- FG 100/48G:** Modulo 52 inserti da 10mm
- FG 100/45I:** Modulo 6 giraviti con impronta TORX
- FG 100/45T:** Modulo 6 giraviti a bussola esagonali
- FG 100/45E:** Modulo 8 giraviti ad intaglio e a croce Phillips
- FG 100/65B:** Modulo pinza autobloccante e pinza regolabile a cerniera aperta
- FG 100/39C:** Modulo 3 pinze assortite
- FG 100/50F:** Modulo 6 chiavi maschio esagonali con impugnatura
- FG 100/10C:** Modulo 8 chiavi a T snodate 7-19mm

ASSORTIMENTO 56 UTENSILI ISOLATI IN MODULI DI GOMMA

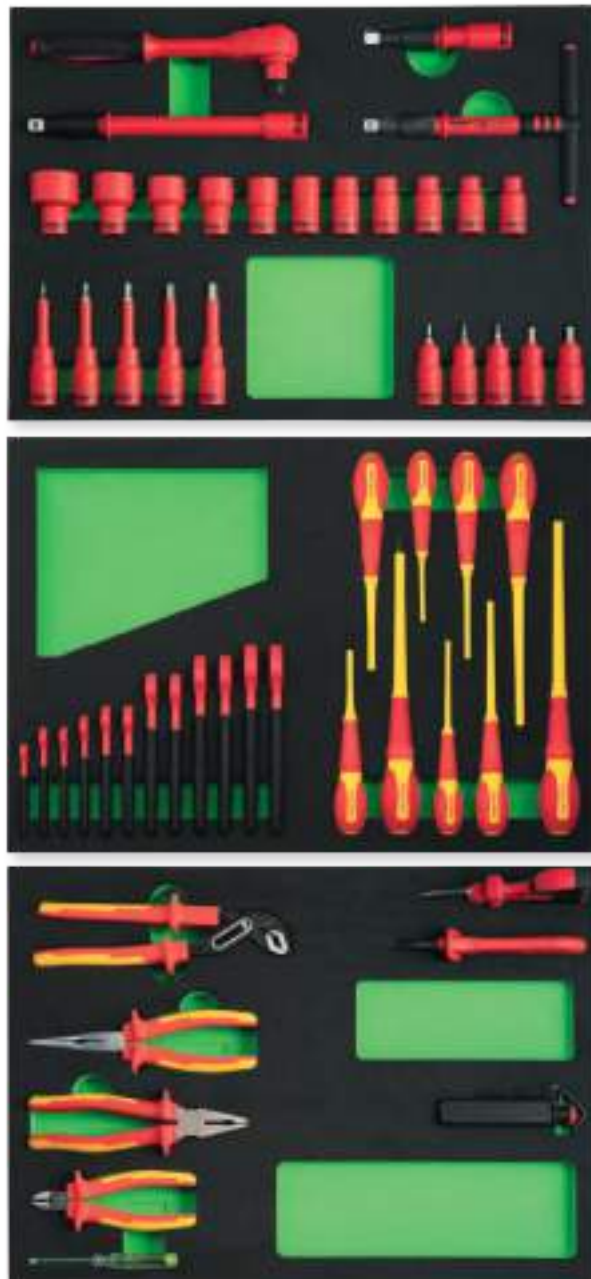

CODICE

FG 100/AS56

€/PZ

1.931,10

- FG 100/21-IS:**
 - Mulo bussole da 1/2 e accessori isolati
 - Chiavi a bussola esagonali da 1/2" 10-32mm
 - Inserti a bussola esagonali corti e lunghi da 1/2" 4-10mm
 - Accessori da 1/2"
- FG 100/03-IS:**
 - Mulo chiavi a forchetta e giraviti isolati
 - Chiavi a forchetta isolate 7-19mm
 - Giraviti isolati a taglio 2.5x75mm, 3x100mm, 5.5x125mm, 6.5x150mm, 8x175mm
 - Giraviti isolati per viti a croce Philips PH0x60, PH1x80, PH2x100, PH3x150
- FG 100/39-IS:**
 - Modulo pinze e utensili da taglio isolati
 - Pinze assortite e tronchese diagonale isolate
 - Forbice con manici isolati
 - Cutter professionale isolato
 - Spellacavi elicoidale

ASSORTIMENTO 171 UTENSILI PER CARROZZERIA IN MODULI DI GOMMA



CODICE	€/PZ
FG 100/AS171	1.801,00

- FG 100/03G:** Modulo 14 chiavi combinate 6 - 19mm
- FG 100/17E:** Modulo 65 utensili da 1/4"
- FG 100/39C:** Modulo 3 pinze assortite
- FG 100/45I:** Modulo 6 giraviti con impronta TORX
- FG 100/52F:** Modulo 5 raschietti in acciaio con manico in ABS
- FG 100/52G:** Modulo 5 utensili carrozzeria
- FG 100/52A:** Modulo 8 levapioli
- FG 100/52B:** Modulo 26 utensili da taglio per carrozzeria
- FG 100/VA4:** Modulo vuoto porta minuterie
- FG 100/52C:** Modulo 5 utensili per cristalli veicoli
- FG 100/52D:** Modulo 10 leve in nylon
- FG 100/52E:** Modulo 5 cunei in plastica
- FG 100/52H:** Modulo utensili manutenzione per carrozzeria

ASSORTIMENTO 284 UTENSILI PER CARROZZERIA IN MODULI DI GOMMA



CODICE	€/PZ
FG 100/AS284	2.950,00

- FG 100/03G:** Modulo 14 chiavi combinate 6 - 19mm
- FG 100/17E:** Modulo 65 utensili da 1/4"
- FG 100/21TX:** Modulo 44 utensili con impronta Torx
- FG 100/45F:** Modulo 6 giraviti con testa a croce phillips
- FG 100/45I:** Modulo 6 giraviti con impronta TORX
- FG 100/45T:** Modulo 5 giraviti a bussola esagonale
- FG 100/56C:** Modulo utensili da percussione
- FG 100/81F:** Modulo inserti a bussola esagonali e XZN
- FG 100/21M:** Modulo chiavi a bussola esagonali
- FG 100/39C:** Modulo 3 pinze con manici rivestiti in bi-materiale
- FG 100/50G:** Modulo 6 chiavi maschio TORX
- FG 100/68:** Modulo 5 levapioli
- FG 100/52A:** Modulo 8 levapioli
- FG 100/52B:** Modulo 26 utensili da taglio per carrozzeria
- FG 100/VA4:** Modulo vuoto porta minuterie
- FG 100/52C:** Modulo 5 utensili per cristalli veicoli
- FG 100/52D:** Modulo 10 leve in nylon
- FG 100/52E:** Modulo 5 cunei in plastica
- FG 100/52F:** Modulo 5 raschietti in acciaio con manico in ABS
- FG 100/52G:** Modulo 5 utensili carrozzeria
- FG 100/52H:** Modulo utensili manutenzione per carrozzeria
- FG 100/VA1:** Modulo vuoto porta minuterie



MODULO 8 CHIAVI DOPPIA FORCHETTA

FG 602/B6x7, 8x9, 10x11, 12x13, 14x15, 16x17, 18x19, 20x22 mm + FG 139C/FS



CODICE	Dimensioni mm	€/PZ
FG 102/03E	398x189	80,00
FG TER 102/03E		15,00

MODULO 5 CHIAVI DOPPIA FORCHETTA

FG 602/B21x23, 24x26, 25x28, 27x29, 30x32 mm

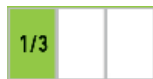

CODICE	Dimensioni mm	€/PZ
FG 102/03F	398x189	96,00
FG TER 102/03F		20,00

MODULO 14 CHIAVI COMBinate IN MM

FG 600/B6,7,8,9,10,11,12,13, 14,15,16,17,18,19mm



CODICE	Dimensioni mm	€/PZ
FG 102/03G	398x189	140,00
FG TER 102/03G		15,00

MODULO 18 CHIAVI COMBinate IN MM

FG 600/B6,7,8,10,11,12,13,14,16,17,18,19, 21, 22, 24, 27, 30, 32mm



CODICE	Dimensioni mm	€/PZ
FG 102/03H	398x377	250,00
FG TER 102/03H		20,00

MODULO 6 CHIAVI COMBinate

FG 600/B21, 22, 24, 27, 30, 32 mm



CODICE	Dimensioni mm	€/PZ
FG 102/03L	398x189	145,00
FG TER 102/03L		15,00

MODULO 7 CHIAVI DOPPIE POLIGONALI

FG 615/B6x7, 8x9, 10x11,12x13, 14x15, 16x17, 18x19mm



CODICE	Dimensioni mm	€/PZ
FG 102/07C	398x189	96,00
FG TER 102/07C		15,00

MODULO 5 CHIAVI DOPPIE POLIGONALI

FG 615/B20x22, 21x23, 24x27, 25x28, 30x32mm



CODICE	Dimensioni mm	€/PZ
FG 102/07D	398x189	135,00
FG TER 102/07D		15,00

MODULO 11 CHIAVI A CRICCO REVERSIBILE

FG 605/B8, 10, 11, 12, 13, 14, 15, 16, 17, 18, 19mm



CODICE	Dimensioni mm	€/PZ
FG 102/08C	398x189	245,00
FG TER 102/08C		15,00

MODULO 8 CHIAVI A T SNODATE

FG 618/A7, 8, 10, 11, 13, 14, 17, 19 mm



CODICE	Dimensioni mm	€/PZ
FG 102/10C	398x566	330,00
FG TER 102/10C		24,00

MODULO CHIAVI A BUSSOLA ESAGONALI

FG 615/B6x7, 8x9, 10x11,12x13, 14x15, 16x17, 18x19mm



1/3

1/4"

CODICE	Dimensioni mm	€/PZ
FG 102/17	398x189	132,00
FG TER 102/17		15,00

CONTENUTO

	FG 624/E	4,5,6,7,8,9,10,11,12,13,14mm
	FG 624/CR14	
	FG 624/ES14	
	FG 624/PA	50, 100
	FG 624/PRF150	
	FG 624/GR14C	
	FG 624/SN14	

MODULO CHIAVI A BUSSOLA ESAGONALI

FG 605/B8, 10, 11, 12, 13, 14, 15, 16, 17, 18, 19mm



1/3

1/4"

CODICE	Dimensioni mm	€/PZ
FG 102/17E	398x189	265,00
FG TER 102/17E		15,00

MODULO CHIAVI A BUSSOLA ESAGONALI



1/3

3/8"

CODICE	Dimensioni mm	€/PZ
FG 102/19	398x189	200,00
FG TER 102/19		15,00

CONTENUTO

	FG 624/B	8,9,10,11,12,13,14,15,16,17,18,19,21,22,23mm
	FG 624/CR38	
	FG 624B/PA	75,125,150,250mm
	FG 624/ES38	
	FG 624/SN38	

MODULO CHIAVI A BUSSOLA ESAGONALI



1/3

1/2"

CODICE	Dimensioni mm	€/PZ
FG 102/21B	398x189	240,00
FG TER 102/21B		15,00

CONTENUTO

	FG 625/A	10,11,12,13,14,15,16,17,18,19,20,21,22,23,24,25,26,27,30,32
	FG 625/CR12	
	FG 625/SN12	
	FG 625/ES12	
	FG 625/PA	125,250

MODULO CHIAVI A BUSSOLA POLIGONALI



1/3

1/2"

CODICE	Dimensioni mm	€/PZ
FG 102/21C	398x189	240,00
FG TER 102/21C		15,00

CONTENUTO

	FG 625/C	10,11,12,13,14,15,16,17,18,19,20,21,22,23,24,25,26,27,30,32
	FG 625/CR12	
	FG 625/SN12	
	FG 625/ES12	
	FG 625/PA	125,250

MODULO CHIAVI A BUSSOLA POLIGONALI



1/3

1/2"

CODICE	Dimensioni mm	€/PZ
FG 102/21D	398x189	165,00
FG TER 102/21D		15,00

CONTENUTO

	FG 625/C	8,10,12,13,15,17,19,21,24,27,30,32
	FG 625/CR12	
	FG 625/SN12	
	FG 625/ES12	
	FG 625/PA	125,250



MODULO CHIAVI A BUSSOLA ESAGONALI



1/3

1/2"

CODICE	Dimensioni mm	€/PZ
FG 102/21E	398x189	165,00
FG TER 102/21E		15,00

CONTENUTO

	FG 625/A	8,10,12,13,15,17,19,21,24,27,30,32
	FG 625/CR12	
	FG 625/SN12	
	FG 625/ES12	
	FG 625/PA	125,250

MODULO UTENSILI CON IMPRONTA TORX



1/3

1/2"

1/4"

CODICE	Dimensioni mm	€/PZ
FG 102/21TX	398x189	235,00
FG TER 102/21TX		15,00

CONTENUTO

	FG 624/TX	4-10
	FG 625/TX	8-24
	FG 147/TX	9-40
	FG 150/TX	10-60
	FG 138/C	

MODULO INSERTI A BUSSOLA

FG 150/H2-H8, FG 150L/H2-H8, FG 150/M5-M16, FG 150L/M5-M16



1/3



CODICE	Dimensioni mm	€/PZ
FG 102/21H	398x189	200,00
FG TER 102/21H		15,00

MODULO INSERTI A BUSSOLA RIBE

FG 150/R4-R14, FG 150L/R4-R14, FG 150/R4-R14, FG 150L/R4-R14



1/3

CODICE	Dimensioni mm	€/PZ
FG 102/21R	398x189	220,00
FG TER 102/21R		15,00

MODULO CHIAVI A BUSSOLA ESAGONALI



2/3

3/4"

CODICE	Dimensioni mm	€/PZ
FG 102/25	398x377	395,00
FG TER 102/25		20,00

CONTENUTO

	FG 629/B	34,36,41,46,50mm
	FG 629/CR34	
	FG 629/SN34	
	FG 629/ES34	
	FG 629/PR200	

MODULO CHIAVI A BUSSOLA POLIGONALI



2/3

3/4"

CODICE	Dimensioni mm	€/PZ
FG 102/25B	398x377	395,00
FG TER 102/25B		20,00

CONTENUTO

	FG 629/B	34,36,41,46,50mm
	FG 629/CR34	
	FG 629/SN34	
	FG 629/ES34	
	FG 629/PR200	

MODULO 13 CHIAVI A BUSSOLA RINFORZATE

FG 628/C10,11,12,13,14,16,17,18,19,21,22,23,24mm + FG 628/PR125



1/3

1/2"

CODICE	Dimensioni mm	€/PZ
FG 102/23C	398x189	145,50
FG TER 102/23C		15,00

MODULO 10 CHIAVI A PIPA 6X12PT

FG 613/A6,7,8,10,11,12,13,14,17,19mm



1/3

CODICE	Dimensioni mm	€/PZ
FG 102/13C	398x189	185,00
FG TER 102/13C		20,00

MODULO 7 CHIAVI MASCHIO ESAGONALI

FG 621/H2, 2.5, 3, 4, 5, 6, 8mm



1/3



CODICE	Dimensioni mm	€/PZ
FG 102/51H	398x189	130,00
FG TER 102/51H		15,00

MODULO 3 PINZE - SERIE INDUSTRIAL

FG 59/XT180 - FG 61/XT160 - FG 63/XT160



1/3

CODICE	Dimensioni mm	€/PZ
FG 102/39XT	398x189	96,00
FG TER 102/39XT		15,00

MODULO 3 PINZE

FG 59SR/180, FG 60SR/160, FG 63SR/160



1/3

CODICE	Dimensioni mm	€/PZ
FG 102/39C	398x189	85,00
FG TER 102/39C		15,00

MODULO 3 PINZE

FG 59PV/180, FG 61PV/160, FG 63PV/160



1/3

CODICE	Dimensioni mm	€/PZ
FG 102/39D	398x189	74,00
FG TER 102/39D		15,00

MODULO 4 PINZE PER ANELLI ELASTICI

FG 51/140, FG 52/140, FG 53/140, FG 54/140



1/3

CODICE	Dimensioni mm	€/PZ
FG 102/41C	398x189	96,00
FG TER 102/41C		15,00

MODULO 4 PINZE PER ANELLI ELASTICI

FG 51/180, FG 52/180, FG 53/180, FG 54/180



1/3

CODICE	Dimensioni mm	€/PZ
FG 102/42C	398x189	106,00
FG TER 102/42C		15,00



MODULO 6 GIRAVITI TAGLIO E CROCE

FG 22/3x100, 4x125, 5.5x150, 6.5x150, FG 22/PH1x80, PH2x150



CODICE	Dimensioni mm	€/PZ
FG 102/45D	398x189	45,00
FG TER 102/45D		15,00

MODULO 8 GIRAVITI TAGLIO E CROCE

3x100, 4x125, 5.5x150, 6.5x150, 6.5x38, PH1x80, PH2x150, PH2x38



CODICE	Dimensioni mm	€/PZ
FG 102/45E	398x189	55,00
FG TER 102/45E		15,00

MODULO 6 GIRAVITI A CROCE PHILLIPS

PH0x60, PH1x150, PH2x100, PH2x150, PH3x150, PH2x38



CODICE	Dimensioni mm	€/PZ
FG 102/45F	398x189	52,00
FG TER 102/45F		15,00

MODULO 7 GIRAVITI A TAGLIO

2.5x60, 3x100, 3.5x100, 4x125, 5.5x150, 5.5x100, 6.5x150



CODICE	Dimensioni mm	€/PZ
FG 102/45G	398x189	52,00
FG TER 102/45G		15,00

MODULO 12 GIRAVITI TAGLIO E CROCE



CODICE	Dimensioni mm	€/PZ
FG 102/45U	398x377	96,00
FG TER 102/45U		20,00

MODULO 6 GIRAVITI CON IMPRONTA TORX

TX10, TX15, TX20, TX25, TX27, TX30



CODICE	Dimensioni mm	€/PZ
FG 102/45I	398x189	64,00
FG TER 102/45I		15,00

MODULO 6 GIRAVITI CON IMPRONTA TORX FORATA

TX10, TX15, TX20, TX25, TX27, TX30



CODICE	Dimensioni mm	€/PZ
FG 102/45L	398x189	65,00
FG TER 102/45L		15,00

MODULO 6 GIRAVITI A BUSSOLA ESAGONALE

FG 22/FX6,FX7,FX8,FX10,FX13



CODICE	Dimensioni mm	€/PZ
FG 102/45T	398x189	75,00
FG TER 102/45T		15,00

MODULO 52 INSERTI - ATTACCO 10MM



1/3



CODICE	Dimensioni mm	€/PZ
FG 102/48G	398x189	120,00
FG TER 102/48G		15,00

MODULO 40 INSERTI CON ATTACCO 1/4"



1/3

CODICE	Dimensioni mm	€/PZ
FG 102/48D	189x199	95,00
FG TER 102/48D		15,00

MODULO 6 CHIAVI MASCHIO ESAGONALI

FG 142/2, 2.5, 3, 4, 5, 6



1/3



CODICE	Dimensioni mm	€/PZ
FG 102/50F	398x189	76,00
FG TER 102/50F		15,00

MODULO 6 CHIAVI MASCHIO TORX

FG 143/TX10, TX15, TX20, TX25, TX27, TX30



1/3



CODICE	Dimensioni mm	€/PZ
FG 102/50G	398x189	76,00
FG TER 102/50G		15,00

MODULO UTENSILI DA PERCUSSIONE

FG 132/500, FG 136/40, FG 126/SN1, FG 126/SN3



1/3

CODICE	Dimensioni mm	€/PZ
FG 102/56C	398x189	125,00
FG TER 102/56C		15,00

MODULO UTENSILI PER MANUTENZIONE

FG 44/MT5, FG 50/AR, FG 48/LG, FG 79/SP4, FG 497/OP1

NEW



CODICE	Dimensioni mm	€/PZ
FG 102/60D	398x189	51,00
FG TER 102/60D		15,00

MODULO LIME A TAGLIO MEZZODOLCE

FG 58/B240, FG 69/CJ250



1/3

CODICE	Dimensioni mm	€/PZ
FG 102/62B	398x189	90,00
FG TER 102/62B		15,00

MODULO PINZE AUTOBLOCCANTI

FG 80/8AR, FG 80/8AM, FG 80/8AP, FG 80/8AT, FG 80/8AQ



1/3

CODICE	Dimensioni mm	€/PZ
FG 102/65B	398x189	65,00
FG TER 102/65B		15,00

MODULO VUOTO PORTA MINUTERIE



1/3

CODICE	Dimensioni mm	€/PZ
FG 102/VA1	398x189	15,00



ASSORTIMENTO 190 UTENSILI IN MODULI RIGIDI



ASSORTIMENTO 356 UTENSILI IN MODULI RIGIDI



CODICE

FG 102/AS190

€/PZ

1.450,50

- FG 102/03G:** Modulo 14 chiavi combinate 6 - 19mm
- FG 102/21B:** Modulo chiavi a bussola esagonali 1/2" 8-32mm+acc
- FG 102/17E:** Modulo 65 utensili da 1/4"
- FG 102/48G:** Modulo 52 inserti con attacco 10mm
- FG 102/65B:** Modulo pinza autobloccante e pinza a cerniera
- FG 102/23C:** Modulo 14 utensili rinforzati da 1/2"
- FG 102/10C:** Modulo 8 chiavi a T snodate esagonali 7-19mm
- FG 102/39D:** Modulo 3 pinze
- FG 102/VA1:** Modulo porta minuterie
- FG 102/45D:** Modulo 6 giraviti a taglio e a croce

CODICE

FG 102/AS356

€/PZ

2.552,30

- FG 102/03G:** Modulo 14 chiavi combinate 6 - 19mm
- FG 102/03L:** Modulo 6 chiavi combinate
- FG 102/03E:** Modulo 8 chiavi doppia forchetta
- FG 102/17E:** Modulo utensili con attacco quadro 1/4"
- FG 102/19:** Modulo utensili con attacco quadro 3/8"
- FG 102/21B:** Modulo utensili con attacco quadro 1/2"
- FG 102/21TX:** Modulo utensili TORX con attacco 1/2" e 1/4"
- FG 102/21H:** Modulo inserti a bussola esagonali e XZN - 1/2"
- FG 85/S31:** Set inserti 1/4" + adattatore portainseriti 1/4" x1/4"
- FG 102/21R:** Modulo inserti a bussola RIBE con attacco 1/2"
- FG 102/56C:** Modulo utensili da percussione
- FG 102/39C:** Modulo 3 pinze con manici rivestiti in bi-materiale
- FG 102/42C:** Modulo 4 pinze per anelli elastici
- FG 102/45G:** Modulo 7 giraviti con testa ad intaglio
- FG 102/45F:** Modulo 6 giraviti con testa a croce Phillips
- FG 102/45L:** Modulo 6 giraviti con testa impronta TORX
- FG 102/48G:** Modulo 52 inserti con attacco 10mm + adatt.
- FG 102/65B:** Modulo pinze autobloccanti
- FG 102/62B:** Modulo 5 lime con taglio mezzodolce

ASSORTIMENTO 149 UTENSILI IN MODULI RIGIDI



CODICE	€/PZ
FG 102/AS149	1.342,00

- FG 102/03G:** Modulo 14 chiavi combinate 6 - 19mm
- FG 102/VA1:** Modulo porta minuterie
- FG 102/03L:** Modulo rigido 6 chiavi combinate
- FG 102/17:** Modulo chiavi a bussola 1/4" 4-14mm + acc.
- FG 102/19:** Modulo 18 utensili da 3/8"
- FG 102/21B:** Modulo 25 utensili da 1/2"
- FG 102/45E:** Modulo 8 giraviti ad intaglio e a croce Phillips
- FG 102/45I:** Modulo 6 giraviti con impronta Torx
- FG 102/48D:** Modulo 40 inserti da 1/4" + porta inserti
- FG 102/39D:** Modulo 3 pinze con manici in pvc
- FG 102/42C:** Modulo 4 pinze per anelli elastici 19-60mm
- FG 102/65B:** Modulo pinza autobloccante e pinza regolabile a cerniera aperta

ASSORTIMENTO 158 UTENSILI IN MODULI RIGIDI



CODICE	€/PZ
FG 102/AS158	1.530,00

- FG 102/03G:** Modulo 14 chiavi combinate 6 - 19mm
- FG 102/21B:** Modulo chiavi a bussola esagonali 1/2" 8-32mm + acc.
- FG 102/17:** Modulo chiavi a bussola da 1/4" 4-14mm + acc.
- FG 102/21TX:** Modulo 44 utensili TORX
- FG 102/21H:** Modulo rigido inserti a bussola 1/2" esagonali e XZN
- FG 102/39D:** Modulo 3 pinze con manici in pvc
- FG 102/45F:** Modulo 6 giraviti a croce phillips
- FG 102/45G:** Modulo 7 giraviti ad intaglio
- FG 102/45I:** Modulo 6 giraviti TORX
- FG 102/10C:** Modulo 8 chiavi a T snodate esagonali 7-19mm



ASSORTIMENTO 193 UTENSILI IN MODULI RIGIDI



CODICE	€/PZ
FG 102/AS193	1.490,00

- FG 102/03G: Modulo 14 chiavi combinate 6 - 19mm
- FG 102/03L: Modulo rigido 6 chiavi combinate
- FG 102/21B: Modulo chiavi a bussola esagonali 1/2" 8-32mm + acc.
- FG 102/17E: Modulo 65 utensili da 1/4"
- FG 102/48G: Modulo inserti corti e lunghi con attacco 10mm
- FG 102/45I: Modulo 6 giraviti con impronta Torx
- FG 102/39D: Modulo 3 pinze
- FG 102/42C: Modulo 4 pinze per anelli elastici 19-60mm
- FG 102/45D: Modulo 6 giraviti a taglio e a croce
- FG 102/56C: Modulo utensili da percussione
- FG 102/65B: Modulo pinza autobloccante e inza regolabile a cerniera aperta
- FG 102/62B: Modulo 5 lime a taglio mezzodolce

PORTA ROTOLO

Per FG 100, FG 102, FG 104, FG 105, FG 109, FG 160



CODICE	€/PZ
FG 100/PR	62,00

PORTA LATTINE

Per FG 102, FG 103, FG 104, FG 105, FG 109, FG 160



CODICE	€/PZ
FG 102/PL	58,00

PORTA PC

Per FG 102, FG 103, FG 104, FG 105, FG 109, FG 160



CODICE	€/PZ
FG 102/PC	80,00

TOP IN GOMMA

Per FG 102



CODICE	€/PZ
FG 102/TG	50,00

TOP IN GOMMA

Per FG 104



CODICE	€/PZ
FG 104/TG	65,00

PORTA ROTOLO

Per FG 150



CODICE	€/PZ
FG 150/PR	40,00

PORTA LATTINE

Per FG 150



CODICE	€/PZ
FG 150/PL	65,00

PORTA LATTINE

Per FG 100



CODICE	€/PZ
FG 100/PL	50,00

PORTA AVVITATORE

Per FG 102 ed FG 104



CODICE	€/PZ
FG 102/PA	30,00

SUPPORTO MAGNETICO PORTA UTENSILI



CODICE	Dimensioni mm (LxPxH)	Portata massima kg	€/PZ
FG 94/MI	120x94x400	9	52,00

SUPPORTO MAGNETICO PORTA UTENSILI

PVC anti-graffio



CODICE	€/PZ
FG 94/MS	34,00

PORTAMINUTERIE MAGNETICO



CODICE	Dimensioni mm	€/PZ
FG 94/R	165x245	20,00

PORTAMINUTERIE MAGNETICO



CODICE	Ø mm	€/PZ
FG 94/T	150	17,00



FG 128

MADE IN ITALY

BANCO DA LAVORO 2.0MT

Ripiano superiore in lamiera d'acciaio zincato da 2mm
 Ripiano inferiore in lamiera d'acciaio fornita di serie
 6 montanti
 Predisposizione per fissaggio a pavimento
 Struttura verniciata con vernice epossidica



CODICE	Dimensioni mm (LxPxH)	Portata kg	Peso kg	€/PZ
FG 128/2	2000x670x880	2000	59,5	700,00

BANCO DA LAVORO 2.0MT DOTATO DI 2 CASSETTI

Ripiano superiore in lamiera d'acciaio zincato da 2mm
 Ripiano inferiore in lamiera d'acciaio fornita di serie
 6 montanti
 Predisposizione per fissaggio a pavimento
 Struttura verniciata con vernice epossidica



CODICE	RAL	Dimensioni mm (LxPxH)	Portata kg	Peso kg	€/PZ
FG 128/D2	7021	2000x670x880	2000	74,5	950,00
FG 128/B2	5002	2000x670x880	2000	74,5	950,00
FG 128/R2	3001	2000x670x880	2000	74,5	950,00

FG 129

MADE IN ITALY

BANCO DA LAVORO 2.0MT

Ripiano superiore in lamiera d'acciaio zincato da 3mm
 Ripiano inferiore in lamiera d'acciaio fornita di serie
 6 montanti
 Predisposizione per fissaggio a pavimento
 Struttura verniciata con vernice epossidica



CODICE	Dimensioni mm (LxPxH)	Portata kg	Peso kg	€/PZ
FG 129/2	2000x745x880	2000	77	850,00

BANCO DA LAVORO 2.0MT DOTATO DI 2 CASSETTI

Ripiano superiore in lamiera d'acciaio zincato da 3mm
 Ripiano inferiore in lamiera d'acciaio fornita di serie
 6 montanti
 Predisposizione per fissaggio a pavimento
 Struttura verniciata con vernice epossidica



CODICE	RAL	Dimensioni mm (LxPxH)	Portata kg	Peso kg	€/PZ
FG 129/D2	7021	2000x745x880	2000	106,5	1.100,00
FG 129/B2	5002	2000x745x880	2000	106,5	1.100,00
FG 129/R2	3001	2000x745x880	2000	106,5	1.100,00

BANCO DA LAVORO 1.0MT

Ripiano superiore in lamiera d'acciaio zincato da 3mm
 Ripiano inferiore in lamiera d'acciaio fornita di serie
 2 montanti
 Predisposizione per fissaggio a pavimento
 Struttura verniciata con vernice epossidica

CODICE	Dimensioni mm (LxPxH)	Portata kg	Peso kg	€/PZ
FG 129/1	1000x745x880	2000	58	550,00



BANCO DA LAVORO 1.0MT DOTATO DI 1 CASSETTO

Ripiano superiore in lamiera d'acciaio zincato da 3mm
 Ripiano inferiore in lamiera d'acciaio fornita di serie
 2 montanti
 Predisposizione per fissaggio a pavimento
 Struttura verniciata con vernice epossidica



CODICE	RAL	Dimensioni mm (LxPxH)	Portata kg	Peso kg	€/PZ
FG 129/D1	7021	1000x745x880	2000	64,5	690,00
FG 129/B1	5002	1000x745x880	2000	64,5	690,00
FG 129/R1	3001	1000x745x880	2000	64,5	690,00



BANCO DA LAVORO 1.5MT

Ripiano superiore in lamiera d'acciaio zincato da 3mm
 Ripiano inferiore in lamiera d'acciaio fornita di serie
 2 montanti
 Predisposizione per fissaggio a pavimento
 Struttura verniciata con vernice epossidica

CODICE	Dimensioni mm (LxPxH)	Portata kg	Peso kg	€/PZ
FG 129/1.5	1500x745x880	2000	77	650,00



BANCO DA LAVORO 1.5MT DOTATO DI 1 CASSETTO

Ripiano superiore in lamiera d'acciaio zincato da 3mm
 Ripiano inferiore in lamiera d'acciaio fornita di serie
 2 montanti
 Predisposizione per fissaggio a pavimento
 Struttura verniciata con vernice epossidica



CODICE	RAL	Dimensioni mm (LxPxH)	Portata kg	Peso kg	€/PZ
FG 129/D1.5	7021	1500x745x880	2000	83,5	790,00
FG 129/B1.5	5002	1500x745x880	2000	83,5	790,00
FG 129/R1.5	3001	1500x745x880	2000	83,5	790,00



BANCO DA LAVORO 2.0MT CON RIPIANO IN ACCIAIO E CASSETTIERA 5 CASSETTI

Ripiano superiore in lamiera d'acciaio zincata 3mm
 Bordatura laterale lungo tutto il perimetro del piano di lavoro
 Cassetteria a 5 cassetti montati su guide telescopiche
 Chiusura centralizzata



CODICE	RAL	Dimensioni mm (LxPxH)	Peso kg	€/PZ
FG 131/D2	7021	2000x745x920	122	1.700,00
FG 131/B2	5002	2000x745x920	122	1.700,00
FG 131/R2	3001	2000x745x920	122	1.700,00

BANCO DA LAVORO 2.0MT CON RIPIANO IN ACCIAIO E 2 CASSETTIERE 5 CASSETTI

Ripiano superiore in lamiera d'acciaio zincata 3mm
 Bordatura laterale lungo tutto il perimetro del piano di lavoro
 2 cassettiere a 5 cassetti montati su guide telescopiche
 Chiusura centralizzata



CODICE	RAL	Dimensioni mm (LxPxH)	Peso kg	€/PZ
FG 132/D2	7021	2000x745x920	163	2.350,00
FG 132/B2	5002	2000x745x920	163	2.350,00
FG 132/R2	3001	2000x745x920	163	2.350,00



BANCO DA LAVORO 2.0MT CON CASSETTI E PARETE PORTAUTENSILI

Ripiano superiore in lamiera d'acciaio 3mm
 Ripiano inferiore in lamiera d'acciaio 3mm fornita di serie
 6 montanti
 2 cassette dotate di sistema di chiusura con chiave
 Predisposizione per fissaggio a pavimento
 Struttura verniciata con vernice epossidica
 Parete portautensili con tapparella in alluminio e serratura



CODICE	RAL	Dimensioni mm (LxPxH)	Peso kg	€/PZ
FG 133/D2	7021	2000x745x1810	156,5	2.300,00
FG 133/B2	5002	2000x745x1810	156,5	2.300,00
FG 133/R2	3001	2000x745x1810	156,5	2.300,00

BANCO DA LAVORO 2.0MT CON RIPIANO IN ACCIAIO, CASSETTIERA A 5 CASSETTI E PARETE PORTAUTENSILI



CODICE	RAL	Dimensioni mm (LxPxH)	€/PZ
FG 134/D2	7021	2000x745x1810	3.000,00
FG 134/B2	5002	2000x745x1810	3.000,00
FG 134/R2	3001	2000x745x1810	3.000,00

BANCO DA LAVORO 2.0MT CON RIPIANO IN ACCIAIO, 2 CASSETTIERE A 5 CASSETTI E PARETE PORTAUTENSILI



CODICE	RAL	Dimensioni mm (LxPxH)	€/PZ
FG 135/D2	7021	2000x745x1810	3.600,00
FG 135/B2	5002	2000x745x1810	3.600,00
FG 135/R2	3001	2000x745x1810	3.600,00



BANCO DA LAVORO 2.0MT DOTATO DI 2 CASSETTI, CON RIPIANO IN LEGNO

Ripiano superiore in legno laminato 25mm
 Ripiano inferiore in lamiera d'acciaio 1,5mm fornita di serie
 6 montanti
 2 cassetti dotati di sistema di chiusura con chiave
 Predisposizione per fissaggio a pavimento
 Struttura verniciata con vernice epossidica



CODICE	RAL	Dimensioni mm (LxPxH)	Peso kg	€/PZ
FG 129/LD2	7021	2000x640x900	106,5	980,00
FG 129/LB2	5002	2000x640x900	106,5	980,00
FG 129/LR2	3001	2000x640x900	106,5	980,00

BANCO DA LAVORO 2.0MT CON RIPIANO IN FAGGIO E CASSETTIERA A 5 CASSETTI

Spessore ripiano 32 mm



CODICE	RAL	Dimensioni mm (LxPxH)	€/PZ
FG 131/FD2	7021	2000x745x910	1.800,00
FG 131/FB2	5002	2000x745x910	1.800,00
FG 131/FR2	3001	2000x745x910	1.800,00

BANCO DA LAVORO 2.0MT CON RIPIANO IN FAGGIO E 2 CASSETTIERE A 5 CASSETTI

Spessore ripiano 32 mm



CODICE	RAL	Dimensioni mm (LxPxH)	€/PZ
FG 132/FD2	7021	2000x745x910	2.400,00
FG 132/FB2	5002	2000x745x910	2.400,00
FG 132/FR2	3001	2000x745x910	2.400,00

PARETE PORTAUTENSILI CON TAPPARELLA IN ALLUMINIO

Tapparella in alluminio
2 maniglie in plastica
Chiusura centralizzata
Appendibile a muro mediante asole



CODICE	RAL	Dimensioni mm (LxPxH)	Peso kg	€/PZ
FG 128/GR2	7021	1700x930x160	50	1.500,00
FG 128/BR2	5002	1700x160x930	50	1.500,00
FG 128/RR2	3001	1700x160x930	50	1.500,00

PANNELLO FORATO DOTATO DI MENSOLA PORTA OGGETTI

PANNELLO FORATO DOTATO DI MENSOLA PORTA OGGETTI



CODICE	RAL	Dimensioni mm (LxPxH)	€/PZ	CODICE	RAL	Dimensioni mm (LxPxH)	€/PZ
FG 129/GR1	7021	945x120x860	160,00	FG 129/GR1.5	7021	1440x120x860	225,00
FG 129/BR1	5002	945x120x860	160,00	FG 129/BR1.5	5002	1440x120x860	225,00
FG 129/RR1	3001	945x120x860	160,00	FG 129/RR1.5	3001	1440x120x860	225,00

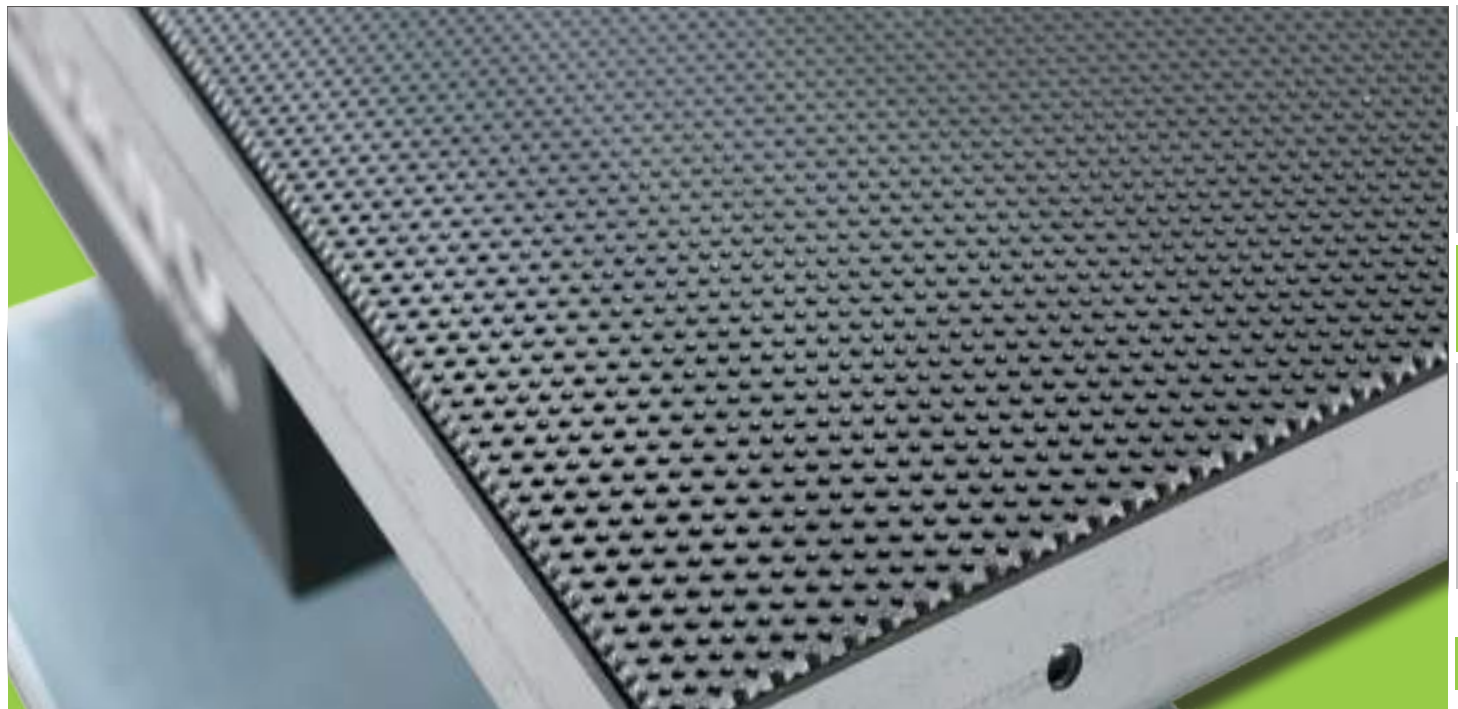

BANCO DA LAVORO 1.5MT CON VASCA DI RACCOLTA

Speciale ripiano dotato di griglia con fori a maglia stretta
 Ripiano a vasca dotato di pendenza e fori centrali
 Ripiano inferiore in lamiera d'acciaio da 1.5mm
 Vasca di raccolta estraibile con portata da 30 litri
 Rubinetto di scarico



CODICE	RAL	Dimensioni mm (LxPxH)	Peso kg	€/PZ
FG 136/D1.5	7021	1500x745x920	85	1.250,00
FG 136/B1.5	5002	1500x745x920	85	1.250,00
FG 136/R1.5	3001	1500x745x920	85	1.250,00

BANCO DA LAVORO 1.5MT CON VASCA DI RACCOLTA DI COLORE E RUOTE GIREVOLI

Speciale ripiano dotato di griglia con fori a maglia stretta
 Ripiano a vasca dotato di pendenza e fori centrali
 Ripiano inferiore in lamiera d'acciaio da 1.5mm
 Vasca di raccolta estraibile con portata da 30 litri
 Rubinetto di scarico
 4 ruote girevoli



CODICE	RAL	Dimensioni mm (LxPxH)	Peso kg	€/PZ
FG 137/D1.5	7021	1500x745x920	90	1.400,00
FG 137/B1.5	5002	1500x745x920	90	1.400,00
FG 137/R1.5	3001	1500x745x920	90	1.400,00

BANCO DA LAVORO 1.0MT CON RIPIANO IN ACCIAIO INOX FIORETTATO

Vasca di raccolta estraibile dotata di rubinetto di spurgo con portata da 30 litri



BANCO DA LAVORO 1.0MT CON RIPIANO IN ACCIAIO INOX FIORETTATO

Vasca di raccolta estraibile dotata di rubinetto di spurgo con portata da 30 litri



CODICE	Dimensione mm	€/PZ	CODICE	Dimensione mm	€/PZ
FG 130/A1	1000x750x915	1.220,00	FG 131/A1	1000x750x915	1.350,00

BANCO DA LAVORO 1.0MT CON RIPIANO IN LAMIERA D'ACCIAIO

Vasca di raccolta estraibile dotata di rubinetto di spurgo con portata da 30 litri



CODICE	Dimensione mm	€/PZ
FG 130/D1	1000x750x915	850,00

BANCO DA LAVORO 1.0MT CON RIPIANO IN LAMIERA D'ACCIAIO

Vasca di raccolta estraibile dotata di rubinetto di spurgo con portata da 30 litri



CODICE	Dimensione mm	€/PZ
FG 131/D1	1000x750x915	1.000,00

CARRELLO PORTA ATTREZZI IN LAMIERA D'ACCIAIO

Lamiera d'acciaio: 1mm

2 ruote fisse e 2 ruote girevoli con freno (Ø100mm)

Profondità ripiano: 7,8 cm



CODICE	Dimensioni mm (LxPxH)	Peso kg	€/PZ
FG 107/A	730x380x780	16,4	165,00

CARRELLO PORTA ATTREZZI IN LAMIERA D'ACCIAIO

Lamiera d'acciaio 1.5mm

Ruote montate su supporto rotante a piastra con gruppo rotante realizzato con doppia corona di sfere

2 ruote fisse, 1 girevole + 1 girevole con freno (Ø80mm)

Portata statica distribuita sui 3 ripiani 560kg



CODICE	Dimensioni mm (LxPxH)	Peso kg	€/PZ
FG 106/A	750x350x957	19,5	250,00

CARRELLO PORTA ATTREZZI IN LAMIERA D'ACCIAIO

Lamiera d'acciaio 1.5mm

Ruote montate su supporto rotante a piastra con gruppo rotante realizzato con doppia corona di sfere

2 ruote fisse, 1 girevole + 1 girevole con freno (Ø100mm)

Portata statica distribuita sui 3 ripiani 600kg



CODICE	Dimensioni mm (LxPxH)	Peso kg	€/PZ
FG 106/B	930x430x957	22	300,00

CARRELLO PORTA ATTREZZI IN LAMIERA D'ACCIAIO - MOD. GIGANTE

Lamiera d'acciaio da 2.0mm

Ruote montate su supporto rotante a piastra con gruppo rotante realizzato con doppia corona di sfere

2 ruote fisse, 1 girevole + 1 girevole con freno (Ø125mm)

Portata statica distribuita sui 3 ripiani 800kg



CODICE	Dimensioni mm (LxPxH)	Peso kg	€/PZ
FG 106/C	1000x560x987	44	390,00



FASANO
TOOLS



FASANO
TOOLS



16

ARREDAMENTO TECNICO



 **FASANO**



MADE IN ITALY



PRESE IN DOTAZIONE
PRESA 220V A 2 POLI + 1 PRESA
SHUKO A 2 POLI + USB



MODULO DISTRIBUZIONE OLIO,
DOTATO DI 2 PISTOLE DIGITALI
CONTA LITRI



PENSILI DOTATI DI PISTONI A GAS
PER AGEVOLARE L'APERTURA/
CHIUSURA DELLO SPORTELLO



**DISPONIBILE IN 3
VARIANTI COLORE**

**RAL
6018**

**RAL
5002**

**RAL
3001**



VANO PORTA RIFIUTI
MONTATO SU GUIDE TELESCOPICHE



PIANO DI LAVORO IN ACCIAIO E INOX
E VASCA DI RACCOLTA ESTRAIBILE



CASSETTI PREDISPOSTI PER
L'INSERIMENTO DEI MODULI
COMPLETI DI UTENSILI

CONFIGURAZIONE DI ARREDAMENTO TECNICO DA 2050MM

FG 118V/205D: Struttura base per configurazione da 2050mm, dotata di 2 pensili superiori con pistoni a gas e serratura di chiusura
 FG 118V/69E: Modulo porta rifiuti differenziati dotato di due contenitori interni in plastica
 FG 118M/40D: Modulo distribuzione aria compressa
 FG 118/69V7: Cassettiera fissa a 7 cassetti
 2 griglie porta utensili
 4 Prese in dotazione: 2 presa 220V a 2 poli, 2 presa Schuko a 2 poli + USB



CODICE	Dimensioni mm (LxPxH)	€/PZ
FG 118/CO1V	2050x757x2000	6.110,00
FG 118/CO1B	2050x757x2000	6.110,00
FG 118/CO1R	2050x757x2000	6.110,00

CONFIGURAZIONE DI ARREDAMENTO TECNICO DA 2050MM

FG 118V/205A: Struttura base per configurazione da 2050mm, dotata di 2 pensili superiori con pistoni a gas e serratura di chiusura
 FG 118V/69A: Modulo armadietto con 2 antine
 FG 118V/7T: Cassettiera mobile a 7 cassetti
 FG 118M/40F: Modulo porta carta dotato di cassetto porta rifiuti
 2 griglie porta utensili
 2 Prese in dotazione: 1 presa 220V a 2 poli, 1 presa Schuko a 2 poli + USB



CODICE	Dimensioni mm (LxPxH)	€/PZ
FG 118/CO2V	2050x757x2000	5.840,00
FG 118/CO2B	2050x757x2000	5.840,00
FG 118/CO2R	2050x757x2000	5.840,00

CONFIGURAZIONE DI ARREDAMENTO TECNICO DA 2550MM

FG 118V/205A: Struttura base per configurazione da 2050mm, dotata di 2 pensili superiori con pistoni a gas e serratura di chiusura
 FG 118V/AR1V: Armadio porta oggetti in metallo ad 1 antina
 FG 118V/69A: Modulo armadietto con 2 antine
 FG 118V/7T: Cassettiera mobile a 7 cassetti
 FG 118M/40F: Modulo porta carta dotato di cassetto porta rifiuti
 2 griglie porta utensili
 2 Prese in dotazione: 1 presa 220V a 2 poli, 1 presa Schuko a 2 poli + USB



CODICE	Dimensioni mm (LxPxH)	€/PZ
FG 118/CO3V	2550x757x2000	6.620,00
FG 118/CO3B	2550x757x2000	6.620,00
FG 118/CO3R	2550x757x2000	6.620,00

CONFIGURAZIONE DI ARREDAMENTO TECNICO DA 2050MM

FG 118V/205D: Struttura base per configurazione da 2050mm, dotata di 2 pensili superiori con pistoni a gas e serratura di chiusura
 FG 118M/69B: Modulo distribuzione olio
 FG 118M/40D: Modulo distribuzione aria compressa
 FG 118/69V7: Cassettiera fissa a 7 cassetti
 2 griglie porta utensili
 4 Prese in dotazione: 2 presa 220V a 2 poli, 2 presa Schuko a 2 poli + USB



CODICE	Dimensioni mm (LxPxH)	€/PZ
FG 118/CO4V	2050x757x2000	8.560,00
FG 118/CO4B	2050x757x2000	8.560,00
FG 118/CO4R	2050x757x2000	8.560,00

CONFIGURAZIONE DI ARREDAMENTO TECNICO DA 2050MM

FG 118V/205E: Configurazione con parete portautensili con serrandina
 FG 118V/69E: Modulo porta rifiuti differenziati, dotato di 2 contenitori interni in plastica
 FG 118M/40D: Modulo distribuzione aria compressa
 FG 118/69V7: Cassettiera fissa a 7 cassetti
 4 Prese in dotazione: 2 presa 220V a 2 poli, 2 presa Schuko a 2 poli + USB



CODICE	Dimensioni mm (LxPxH)	€/PZ
FG 118/CO5V	2050x757x2000	7.080,00
FG 118/CO5B	2050x757x2000	7.080,00
FG 118/CO5R	2050x757x2000	7.080,00

CONFIGURAZIONE DI ARREDAMENTO TECNICO DA 3050MM

FG 118V/205E: Configurazione con parete portautensili con serrandina
 2 FG 118V/AR1V: Armadio porta oggetti in metallo ad 1 antina
 FG 118V/69E: Modulo porta rifiuti differenziati, dotato di 2 contenitori interni in plastica
 FG 118M/40B: Modulo distribuzione olio
 FG 118/69V7: Cassettiera fissa a 7 cassetti
 4 Prese in dotazione: 2 presa 220V a 2 poli, 2 presa Schuko a 2 poli + USB



CODICE	Dimensioni mm (LxPxH)	€/PZ
FG 118/CO6V	3050x757x2000	8.580,00
FG 118/CO6B	3050x757x2000	8.580,00
FG 118/CO6R	3050x757x2000	8.580,00



CONFIGURAZIONE DI ARREDAMENTO TECNICO DA 1225MM

FG 118V/122C: Configurazione dotata di piano di lavoro in acciaio Inox e modulo armadietto scarico fluidi

FG 118M/40D: Modulo distribuzione aria compressa

Prese in dotazione: 1 presa 220V a 2 poli, 1 presa Schuko a 2 poli + USB



FG 118/C07B

FG 118/C07R

CODICE	Dimensioni mm (LxPxH)	€/PZ
FG 118/C07V	1225x757x2000	4.400,00
FG 118/C07B	1225x757x2000	4.400,00
FG 118/C07R	1225x757x2000	4.400,00

**CONFIGURAZIONE DI ARREDAMENTO TECNICO DA 1225MM**

FG 118V/122A: Struttura base per configurazione da 1225mm, dotata di pensile superiore

FG 118/69V7: Cassettiera fissa a 7 cassetti

FG 118M/40F: Modulo porta carta dotato di cassetto porta rifiuti

1 griglia portautensili

Prese in dotazione: 1 presa 220V a 2 poli, 1 presa Schuko a 2 poli + USB



FG 118/C08B

FG 118/C08R

CODICE	Dimensioni mm (LxPxH)	€/PZ
FG 118/C08V	1225x757x2000	3.770,00
FG 118/C08B	1225x757x2000	3.770,00
FG 118/C08R	1225x757x2000	3.770,00

**CONFIGURAZIONE DI ARREDAMENTO TECNICO DA 2050MM**

FG 118V/205H: Struttura base per configurazione da 2050mm

FG 118V/69E: Modulo portarifiuti differenziati, dotato di 2 contenitori interni in plastica

FG 118M/40D: Modulo distribuzione aria compressa

FG 118/69V7: Cassettiera fissa a 7 cassetti

4 Prese in dotazione: 2 presa 220V a 2 poli, 2 presa Schuko a 2 poli + USB



FG 118/C09B

FG 118/C09R

CODICE	Dimensioni mm (LxPxH)	€/PZ
FG 118/C09V	2050x707x990	5.530,00
FG 118/C09B	2050x707x990	5.530,00
FG 118/C09R	2050x707x990	5.530,00



CONFIGURAZIONE DI ARREDAMENTO TECNICO DA 2050MM

FG 118V/205H: Struttura base per configurazione da 2050mm
 FG 118V/69A: Modulo armadietto con 2 antine
 FG 118V/7T: Cassettiera mobile a 7 cassetti
 FG 118V/40F: Modulo porta carta, dotato di cassetti portarifiuti
 Prese in dotazione: 1 presa 220V a 2 poli, 1 presa Schuko a 2 poli + USB



FG 118/CO10B

FG 118/CO10R



CODICE	Dimensioni mm (LxPxH)	€/PZ
FG 118/CO10V	2050x707x990	5.240,00
FG 118/CO10B	2050x707x990	5.240,00
FG 118/CO10R	2050x707x990	5.240,00

CONFIGURAZIONE DI ARREDAMENTO TECNICO DA 1225MM

FG 118V/122H: Struttura base per configurazione da 1225mm
 FG 118V/69A: Modulo armadietto con 2 antine
 FG 118M/40D: Modulo distribuzione aria compressa
 Prese in dotazione: 1 presa 220V a 2 poli, 1 presa Schuko a 2 poli + USB



FG 118/CO15B

FG 118/CO15R



CODICE	Dimensioni mm (LxPxH)	€/PZ
FG 118/CO15V	1225x707x990	3.850,00
FG 118/CO15B	1225x707x990	3.850,00
FG 118/CO15R	1225x707x990	3.850,00

CONFIGURAZIONE DI ARREDAMENTO TECNICO DA 1225MM

FG 118V/122H: Struttura base per configurazione da 1225mm
 FG 118V/69V7: Cassettiera fissa a 7 cassetti
 FG 118M/40F: Modulo porta carta dotato di cassetti portarifiuti
 Prese in dotazione: 1 presa 220V a 2 poli, 1 presa Schuko a 2 poli + USB



FG 118/CO16B

FG 118/CO16R



CODICE	Dimensioni mm (LxPxH)	€/PZ
FG 118/CO16V	1225x707x990	3.440,00
FG 118/CO16B	1225x707x990	3.440,00
FG 118/CO16R	1225x707x990	3.440,00



CONFIGURAZIONE DI ARREDAMENTO TECNICO DA 5600MM

FG 118V/205A: Struttura base per configurazione da 2050mm, dotata di 2 pensili superiori

FG 118V/205D: Struttura base per configurazione da 2050mm, dotata di 2 pensili superiori

FG 118V/AR1V: Armadio porta oggetti in metallo ad 1 anta

FG 118M/69A: Modulo armadietto 2 antine

FG 118V/7T: Cassettiera mobile a 7 cassetti

FG 118M/40F: Modulo porta carta dotato di cassetto portarifiuti

FG 118V/69E: Modulo portarifiuti differenziati, dotato di 2 contenitori interni in plastica

FG 118M/40D: Modulo distribuzione aria compressa

FG 118V/69V7: Cassettiera fissa a 7 cassetti

FG 118V/AR2V: Armadio porta oggetti in metallo a 2 ante

4 griglie portautensili

3 Prese in dotazione: 3 presa 220V a 2 poli, 3 presa Schuko a 2 poli + USB



FG 118/CO20B



FG 118/CO20R



CODICE	Dimensioni mm (LxPxH)	€/PZ
FG 118/CO20V	5600x757x2000	14.500,00
FG 118/CO20B	5600x757x2000	14.500,00
FG 118/CO20R	5600x757x2000	14.500,00



CONFIGURAZIONE DI ARREDAMENTO TECNICO DA 5600MM

FG 118V/205A: Struttura base per configurazione da 2050mm, dotata di 2 pensili superiori

FG 118V/205M: Struttura base per configurazione da 2050mm, dotata di parete a serrandina

FG 118V/AR1V: Armadio porta oggetti in metallo ad 1 anta

FG 118M/69A: Modulo armadietto 2 antine

FG 118V/7T: Cassettiera mobile a 7 cassetti

FG 118M/40F: Modulo porta carta dotato di cassetto portarifiuti

FG 118V/69B: Modulo distribuzione olio

FG 118M/40D: Modulo distribuzione aria compressa

FG 118V/69V7: Cassettiera fissa a 7 cassetti

FG 118V/AR2V: Armadio porta oggetti in metallo a 2 ante

2 griglie portautensili

3 Prese in dotazione: 3 presa 220V a 2 poli, 3 presa Schuko a 2 poli + USB



FG 118/CO21B



FG 118/CO21R



CODICE	Dimensioni mm (LxPxH)	€/PZ
FG 118/CO21V	5600x757x2000	18.030,00
FG 118/CO21B	5600x757x2000	18.030,00
FG 118/CO21R	5600x757x2000	18.030,00



STRUTTURA BASE PER CONFIGURAZIONE DA 2050MM, DOTATO DI PENSILI SUPERIORI

2 pensili superiori con pistoni a gas e serratura di chiusura
Pannelli di chiusura posteriore
Altezza sottopiano 950mm



CODICE	Dimensioni mm (LxPxH)	€/PZ
FG 118V/205L	2050x757x2000	3.680,00
FG 118B/205L	2050x757x2000	3.680,00
FG 118R/205L	2050x757x2000	3.680,00

STRUTTURA BASE PER CONFIGURAZIONE DA 2050MM, DOTATO DI PARTE A SERRANDINA

Parete a serrandina
Pannelli di chiusura posteriore
Altezza sottopiano 950mm



CODICE	Dimensioni mm (LxPxH)	€/PZ
FG 118V/205M	2050x757x2000	4.650,00
FG 118B/205M	2050x757x2000	4.650,00
FG 118R/205M	2050x757x2000	4.650,00

STRUTTURA BASE PER CONFIGURAZIONE DA 2050MM, DOTATO DI PANNELLI PORTAUTENSILI

2 pannelli porta utensili
Pannelli di chiusura posteriore
Altezza sottopiano 950mm



CODICE	Dimensioni mm (LxPxH)	€/PZ
FG 118V/205P	2050x757x2000	3.250,00
FG 118B/205P	2050x757x2000	3.250,00
FG 118R/205P	2050x757x2000	3.250,00

STRUTTURA BASE PER CONFIGURAZIONE DA 2050MM

Pannelli di chiusura posteriore
Altezza sottopiano 950mm



CODICE	Dimensioni mm (LxPxH)	€/PZ
FG 118V/205Q	2050x707x990	3.150,00
FG 118B/205Q	2050x707x990	3.150,00
FG 118R/205Q	2050x707x990	3.150,00

SISTEMA DI ILLUMINAZIONE A LED

Sistema di fissaggio tramite coppia di magneti
600 lumen



CODICE	L/mm	€/PZ
FG 118/LED	900	96,00

GANCIO PORTA UTENSILI



CODICE	Dimensione mm	€/PZ
FG GA/80	80	1,00
FG GA/120	120	1,20
FG GA/T	19	1,30

TRASFORMATORE DA 30 WATT

In caso di più di 1 striscia led è sufficiente considerare 1 trasformatore ogni 2 strisce



CODICE	€/PZ
FG 118/TR	80,00

RIVESTIMENTO IN NBR

Resistente ad olii e idrocarburi



CODICE	L/mm	€/PZ
FG 118/NBR1	1220	98,00
FG 118/NBR2	2055	120,00
FG 118/NBR3	Per moduli angolari	120,00



LA SOLUZIONE MODULARE PER COMPORRE
L'ARREDAMENTO TECNICO

in 3 facili STEP

1 STEP

PARTE SUPERIORE

SELEZIONARE LA STRUTTURA BASE
PER LA PARTE SUPERIORE:



CON PENSILI



CON TAPPARELLA



SOLO GRIGLIA PORTAUTENSILI

SENZA PARTE SUPERIORE
PASSA ALLO STEP 2



2 STEP

PARTE INFERIORE

SELEZIONARE LA STRUTTURA BASE
PER LA PARTE INFERIORE:



CON PREDISPOSIZIONE PER CARRELLO



SENZA PREDISPOSIZIONE PER CARRELLO

3 STEP

MODULI

SELEZIONARE IL MODULO
PER LA PARTE INFERIORE:



CARRELLO



DA 69



DA 40

STRUTTURA BASE PER CONFIGURAZIONI CON PREDISPOSIZIONE CARRELLO

STRUTTURA BASE PER CONFIGURAZIONE DA 2050MM, DOTATO DI PENSILI SUPERIORI

Adatto per moduli da 69cm, da 40cm e per carrelli a 5, 6, 7 cassetti



CODICE	Dimensioni mm (LxPxH)	€/PZ
FG 118V/205A	2050x757x2000	2.750,00
FG 118B/205A	2050x757x2000	2.750,00
FG 118R/205A	2050x757x2000	2.750,00

CONFIGURAZIONE CON PARETE PORTAUTENSILI

Adatto per moduli da 69cm, da 40cm e per carrelli a 5, 6, 7 cassetti



CODICE	Dimensioni mm (LxPxH)	€/PZ
FG 118V/205B	2050x757x2000	3.700,00
FG 118B/205B	2050x757x2000	3.700,00
FG 118R/205B	2050x757x2000	3.700,00

CONFIGURAZIONE CON PANNELLI PORTAUTENSILI

Adatto per moduli da 69cm, da 40cm e per carrelli a 5, 6, 7 cassetti



CODICE	Dimensioni mm (LxPxH)	€/PZ
FG 118V/205C	2050x757x2000	2.200,00
FG 118B/205C	2050x757x2000	2.200,00
FG 118R/205C	2050x757x2000	2.200,00



STRUTTURA BASE PER CONFIGURAZIONE DA 2050MM, DOTATO DI PENSILI SUPERIORI

Adatto per moduli da 69cm, da 40cm e per cassettiere fisse a 5, 6, 7 cassetti



CODICE	Dimensioni mm (LxPxH)	€/PZ
FG 118V/205D	2050x757x2000	2.980,00
FG 118B/205D	2050x757x2000	2.980,00
FG 118R/205D	2050x757x2000	2.980,00



CONFIGURAZIONE CON PARETE PORTAUTENSILI

Adatto per moduli da 69cm, da 40cm e per cassettiere fisse a 5, 6, 7 cassetti



CODICE	Dimensioni mm (LxPxH)	€/PZ
FG 118V/205E	2050x757x2000	3.950,00
FG 118B/205E	2050x757x2000	3.950,00
FG 118R/205E	2050x757x2000	3.950,00



CONFIGURAZIONE CON PANNELLI PORTAUTENSILI

Adatto per moduli da 69cm, da 40cm e per cassettiere fisse a 5, 6, 7 cassetti



CODICE	Dimensioni mm (LxPxH)	€/PZ
FG 118V/205F	2050x757x2000	2.400,00
FG 118B/205F	2050x757x2000	2.400,00
FG 118R/205F	2050x757x2000	2.400,00



STRUTTURA BASE PER CONFIGURAZIONE DA 1225MM, DOTATO DI PENSILI SUPERIORI

Adatto per moduli da 69cm e da 40cm



FG 118B/122A

FG 118R/122A



CODICE	Dimensioni mm (LxPxH)	€/PZ
FG 118V/122A	1225x757x2000	1.750,00
FG 118B/122A	1225x757x2000	1.750,00
FG 118R/122A	1225x757x2000	1.750,00

CONFIGURAZIONE CON PARETE PORTAUTENSILI

Adatto per moduli da 69cm e da 40cm



FG 118B/122B

FG 118R/122B



CODICE	Dimensioni mm (LxPxH)	€/PZ
FG 118V/122B	1225x757x2000	1.360,00
FG 118B/122B	1225x757x2000	1.360,00
FG 118R/122B	1225x757x2000	1.360,00

CONFIGURAZIONE SPECIALE DOTATO DI VASCA DI RACCOLTA FLUIDI IN ACCIAIO INOX

Adatto per moduli da 40cm + armadietto scarico fluidi da 69

Piano di lavoro in acciaio Inox

Vasca di raccolta estraibile



FG 118B/122C

FG 118R/122C



CODICE	Dimensioni mm (LxPxH)	€/PZ
FG 118V/122C	1225x757x2000	3.500,00
FG 118B/122C	1225x757x2000	3.500,00
FG 118R/122C	1225x757x2000	3.500,00



STRUTTURA BASE PER CONFIGURAZIONE ANGOLARE, DOTATA DI GRIGLIE PORTA UTENSILI SEMPLICI



CODICE	Dimensioni mm (LxPxH)	€/PZ
FG 118V/80AN	776x776x2000	1.380,00
FG 118B/80AN	776x776x2000	1.380,00
FG 118R/80AN	776x776x2000	1.380,00



STRUTTURA BASE PER CONFIGURAZIONE ANGOLARE, DOTATA DI GRIGLIE PORTA UTENSILI E MENSOLE AMOVIBILI

Adatto per un modulo da 40cm



CODICE	Dimensioni mm (LxPxH)	€/PZ
FG 118V/138AN	1028x1028x2000	1.480,00
FG 118B/138AN	1028x1028x2000	1.480,00
FG 118R/138AN	1028x1028x2000	1.480,00



STRUTTRA BASE PER CONFIGURAZIONE ANGOLARE



CODICE	Dimensioni mm (LxPxH)	€/PZ
FG 118V/80ANT	726x726x970	920,00
FG 118B/80ANT	726x726x970	920,00
FG 118R/80ANT	726x726x970	920,00



STRUTTRA BASE PER CONFIGURAZIONE ANGOLARE

Adatto per un modulo da 40cm



CODICE	Dimensioni mm (LxPxH)	€/PZ
FG 118V/138ANT	978x978x990	1.020,00
FG 118B/138ANT	978x978x990	1.020,00
FG 118R/138ANT	978x978x990	1.020,00

STRUTTURA BASE PER CONFIGURAZIONE DA 2050MM

Adatto per moduli da 69cm, da 40cm e per carrelli a 5, 6, 7 cassetti



CODICE	Dimensioni mm (LxPxH)	€/PZ
FG 118V/205G	2050x707x990	2.150,00
FG 118B/205G	2050x707x990	2.150,00
FG 118R/205G	2050x707x990	2.150,00

STRUTTURA BASE PER CONFIGURAZIONE DA 2050MM

Adatto per moduli da 69cm, da 40cm e per cassettiere fisse a 5, 6, 7 cassetti



CODICE	Dimensioni mm (LxPxH)	€/PZ
FG 118V/205H	2050x707x990	2.400,00
FG 118B/205H	2050x707x990	2.400,00
FG 118R/205H	2050x707x990	2.400,00

STRUTTURA BASE PER CONFIGURAZIONE DA 1225MM

Adatto per moduli da 69cm e da 40cm



CODICE	Dimensioni mm (LxPxH)	€/PZ
FG 118V/122H	1225x707x990	1.420,00
FG 118B/122H	1225x707x990	1.420,00
FG 118R/122H	1225x707x990	1.420,00



MODULO ARMADIETTO CON ANTINA SINGOLA

Antina apribile a 120°

Ripiani interni amovibili

Dotato di serratura di chiusura

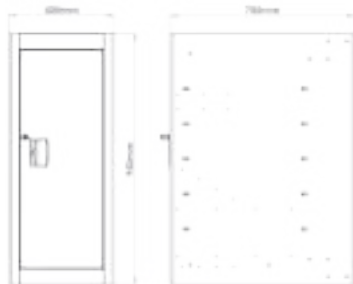

FG 118B/40A

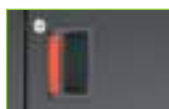

FG 118R/40A

CODICE	Dimensioni mm (LxPxH)	Peso Kg	€/PZ
FG 118V/40A	400x700x950	30	740,00
FG 118B/40A	400x700x950	30	740,00
FG 118R/40A	400x700x950	30	740,00

MODULO DISTRIBUZIONE OLIO

Arrotolatore con tubo flessibile 7,5m-1/2"

Pistola contalitri digitale dotata di sistema salvagoccia (portata max: 40L/min)

Griglia d'appoggio in acciaio Inox

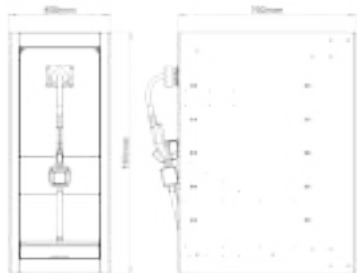

CODICE	Dimensioni mm (LxPxH)	Peso Kg	€/PZ
FG 118M/40B	400x700x950	42	1.960,00

MODULO DISTRIBUZIONE LIQUIDO ANTIREFRIGERANTE

Arrotolatore con tubo flessibile 7,5m-1/2"

Pistola contalitri digitale dotata di sistema salvagoccia (portata max: 35L/min)

Griglia d'appoggio in acciaio Inox

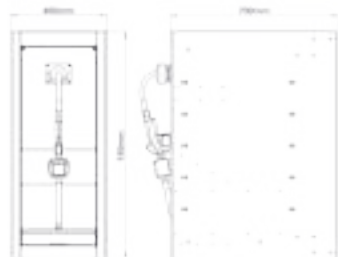

CODICE	Dimensioni mm (LxPxH)	Peso Kg	€/PZ
FG 118M/40C	400x700x950	42	2.100,00

MODULO RECUPERO OLIO

Arrotolatore con tubo flessibile 7,5m-1/2"

Attacco portasonde per tubo flessibile

Kit sonde 10pz

Staffa portasonde

Griglia d'appoggio in acciaio Inox

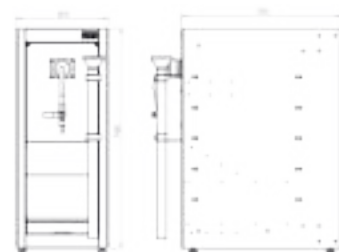

CODICE	Dimensioni mm (LxPxH)	Peso Kg	€/PZ
FG 118M/40G	400x700x950	42	1.960,00

MODULO DISTRIBUZIONE ARIA COMPRESSA + ENERGIA ELETTRICA

Arrotolatore con tubo flessibile da 1/4", 15m

Avvolgitore automatico 15m 3Gx 1,5mm² con presa SHUCKO

CODICE	Dimensioni mm (LxPxH)	Peso Kg	€/PZ
FG 118M/40H	400x700x950	41	1.150,00

MODULO DISTRIBUZIONE ARIA COMPRESSA

Arrotolatore tubo flessibile da 1/4", 15m

Dotato di guida di scorrimento automatico

Sistema di bloccaggio a qualsiasi lunghezza

Riavvolgimento a velocità controllata

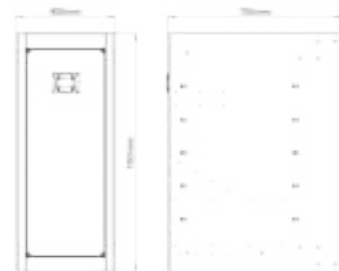

CODICE	Dimensioni mm (LxPxH)	Peso Kg	€/PZ
FG 118M/40D	400x700x950	32,5	900,00

MODULO PORTA RIFIUTI, DOTATO DI CONTENITORE INTERNO IN PLASTICA

Cassetto estraibile montato su guide telescopiche
Portata guide 35kg



CODICE	Dimensioni mm (LxPxH)	Peso Kg	€/PZ
FG 118V/40E	400x700x950	35,5	740,00
FG 118B/40E	400x700x950	35,5	740,00
FG 118R/40E	400x700x950	35,5	740,00

MODULO PORTA CARTA, DOTATO DI CASSETTA PORTA RIFIUTI

Vano portarifiuti montato su guide telescopiche
Portata cassetto 35 kg



CODICE	Dimensioni mm (LxPxH)	Peso Kg	€/PZ
FG 118V/40F	400x700x950	33	740,00
FG 118B/40F	400x700x950	33	740,00
FG 118R/40F	400x700x950	33	740,00

MODULO ARMADIETTO CON 2 ANTINE

Antina apribile a 120°
Ripiani interni amovibili
Dotato di serratura di chiusura



CODICE	Dimensioni mm (LxPxH)	Peso Kg	€/PZ
FG 118V/69A	688x500x948	34	950,00
FG 118B/69A	688x500x948	34	950,00
FG 118R/69A	688x500x948	34	950,00

MODULO DISTRIBUZIONE OLIO

Arrotolatore con tubo flessibile 7,5m-1/2"
2 Pistole contalitri digitale dotata di sistema salvagoccia (portata max: 40L/min)
Griglia d'appoggio in acciaio Inox



CODICE	Dimensioni mm (LxPxH)	Peso Kg	€/PZ
FG 118M/69B	688x500x948	60	3.400,00



MODULO DISTRIBUZIONE E RECUPERO OLIO

Arrotolatore con tubo flessibile 7,5m-1/2"
 Pistola contalitri digitale dotata di sistema salvagoccia (portata max: 40L/min)
 Attacco portasonde per tubo flessibile
 Kit sonde 10 pz
 Staffa porta sonde
 Griglia d'appoggio in acciaio Inox



CODICE	Dimensioni mm (LxPxH)	Peso Kg	€/PZ
FG 118M/69G	688x500x948	60	3.400,00

MODULO PORTA RIFIUTI, DOTATO DI 2 CONTENITORI INTERNI IN PLASTICA

Cassetto estraibile montato su guide telescopiche
 Portata guide 35kg



FG 118B/69E



FG 118R/69E



Cassetto estraibile

CODICE	Dimensioni mm (LxPxH)	Peso Kg	€/PZ
FG 118V/69E	688x500x948	40	950,00
FG 118B/69E	688x500x948	40	950,00
FG 118R/69E	688x500x948	40	950,00

MODULO DISTRIBUZIONE ARIA COMPRESSA + ENERGIA ELETTRICA

Arrotolatore con tubo flessibile da 1/4", 15m
 Avvolgitore automatico 15m 3Gx 1,5mm² con presa SHUCKO



CODICE	Dimensioni mm (LxPxH)	Peso Kg	€/PZ
FG 118M/69H	688x500x948	41	1.350,00

ARMADIO PORTA OGGETTI AD 1 ANTA

Antina apribile a 120°
 4 ripiani interni amovibili e regolabili
 Dotato di sistema di chiusura con serratura



FG 118/AR1B



FG 118/AR1R

CODICE	Dimensioni mm (LxPxH)	Peso Kg	€/PZ
FG 118/AR1V	500x510x2000	53	750,00
FG 118/AR1B	500x510x2000	53	750,00
FG 118/AR1R	500x510x2000	53	750,00

ARMADIO PORTA OGGETTI A 2 ANTE

Antina apribile a 120°

4 ripiani interni amovibili e regolabili

Dotato di sistema di chiusura con serratura



FG 118/AR2B

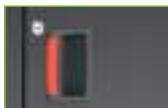

FG 118/AR2R

CODICE	Dimensioni mm (LxPxH)	Peso Kg	€/PZ
FG 118/AR2V	1000x510x2000	86	1.150,00
FG 118/AR2B	1000x510x2000	86	1.150,00
FG 118/AR2R	1000x510x2000	86	1.150,00

ARMADIO PORTA OGGETTI A 3 ANTE, DOTATO DI 3 CASSETTI INTERNI MONTATI SU GUIDE TELESCOPICHE

Antina apribile a 120°

4 ripiani interni amovibili e regolabili

Dotato di sistema di chiusura con serratura

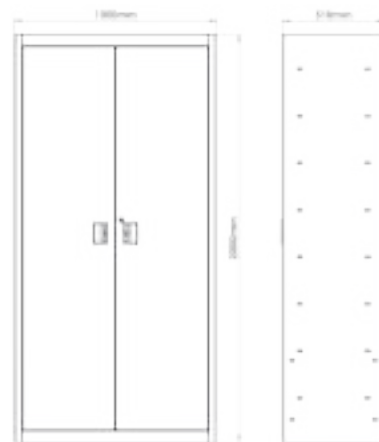

FG 118/AR3B



FG 118/AR3R

CODICE	Dimensioni mm (LxPxH)	Peso Kg	€/PZ
FG 118/AR3V	1000x510x2000	105,5	1.800,00
FG 118/AR3B	1000x510x2000	105,5	1.800,00
FG 118/AR3R	1000x510x2000	105,5	1.800,00





CASSETTIERA FISSA A 5 CASSETTI

CODICE	Dimensioni mm (LxPxH)	Peso Kg	€/PZ
FG 118/69V5	691x500x948	48,5	1.160,00
FG 118/69B5	691x500x948	48,5	1.160,00
FG 118/69R5	691x500x948	48,5	1.160,00



CASSETTIERA FISSA A 6 CASSETTI

CODICE	Dimensioni mm (LxPxH)	Peso Kg	€/PZ
FG 118/69V6	691x500x948	50	1.220,00
FG 118/69B6	691x500x948	50	1.220,00
FG 118/69R6	691x500x948	50	1.220,00



CASSETTIERA FISSA A 7 CASSETTI

CODICE	Dimensioni mm (LxPxH)	Peso Kg	€/PZ
FG 118/69V7	691x500x948	50	1.280,00
FG 118/69B7	691x500x948	50	1.280,00
FG 118/69R7	691x500x948	50	1.280,00





CASSETTIERA MOBILE A 5 CASSETTI

CODICE	Dimensioni mm (LxPxH)	Peso Kg	€/PZ
FG 118V/5T	731x500x916	50	1.280,00
FG 118B/5T	731x500x916	50	1.280,00
FG 118R/5T	731x500x916	50	1.280,00



FG 118V/5T



FG 118B/5T



FG 118R/5T

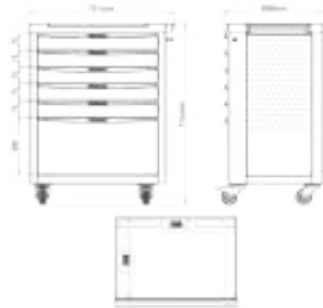

CASSETTIERA MOBILE A 6 CASSETTI

CODICE	Dimensioni mm (LxPxH)	Peso Kg	€/PZ
FG 118V/6T	731x500x916	51	1.340,00
FG 118B/6T	731x500x916	51	1.340,00
FG 118R/6T	731x500x916	51	1.340,00



FG 118V/6T



FG 118B/6T



FG 118R/6T



CASSETTIERA MOBILE A 7 CASSETTI

CODICE	Dimensioni mm (LxPxH)	Peso Kg	€/PZ
FG 118V/7T	731x500x916	52	1.400,00
FG 118B/7T	731x500x916	52	1.400,00
FG 118R/7T	731x500x916	52	1.400,00



FG 118V/7T



FG 118B/7T



FG 118R/7T



MODULAR FORMS

FG 116

NEW



RAL 7021

RAL 6018

13 MODULI SINGOLI
per comporre la configurazione ideale
per il tuo spazio di lavoro

CARRELLI



CASSETTIERE



MODULI MULTIFUNZIONE





POSSIBILITA' DI INSERIRE MODULI DI UTENSILERIA ALL'INTERNO DEI CASSETTI



PIANO DI LAVORO IN ACCIAIO ZINCATO DA 2mm

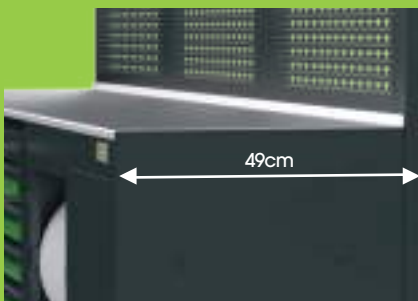

COMPOSIZIONE COMPATTA CON SOLO 49cm DI PROFONDITA'



VANO PORTA RIFIUTI MONTATO SU GUIDE TELESCOPICHE



GRIGLIE PORTA UENSILI

NUOVO SISTEMA DI ARREDAMENTO TECNICO per l'organizzazione e la personalizzazione del tuo spazio di lavoro

COMPATTEZZA:

49 cm di profondità, ideale per arredare anche gli ambienti meno spaziosi

ROBUSTEZZA:

Spessore del piano di lavoro in acciaio zincato: **2mm**
Spessore struttura in lamiera zincata e verniciata: **1mm**

QUALITÀ:

Struttura per griglie e pensili realizzata con colonne montata sugli stessi moduli per un'elevata resistenza nel tempo

FUNZIONALITÀ:

Cassetti predisposti per l'inserimento dei moduli di utensili Fasano Tools

MADE IN ITALY:

Progettato e realizzato in Italia all'interno dei nostri stabilimenti per garantire cura dei dettagli, stile elegante ed attenzione nella scelta dei materiali

VERSATILITÀ:

Sistema flessibile e modulabile, con possibilità di completa personalizzazione oppure scelta di combinazioni predeterminate ampliabili o modificabili nel tempo.



4 TIPOLOGIE DI STRUTTURA BASE

MADE IN ITALY



CONFIGURAZIONI FG 116 DA 2.065mm

CONFIGURAZIONI FG 116 DA 2065MM

FG 116V/68A: Modulo armadietto
 FG 116V/7G: Carrello porta utensili
 FG 116V/68B: Armadietto, porta carta e porta rifiuti



CONFIGURAZIONI FG 116 DA 2065MM

FG 116V/68B: Armadietto, porta carta e porta rifiuti
 FG 116V/7G: Carrello porta utensili
 FG 116M/68E: Modulo aria compressa ed energia



CODICE	Dimensioni mm (LxPxH)	€/PZ
FG 116/CO2V	2065x490x2000	4.305,00

CODICE	Dimensioni mm (LxPxH)	€/PZ
FG 116/CO1V	2065x490x2000	4.770,00

CONFIGURAZIONI FG 116 DA 2065MM

FG 116V/68A: Modulo armadietto
 FG 116/68V7: Cassettiera fissa a 7 cassetti
 FG 116V/68B: Armadietto, porta carta e porta rifiuti



CONFIGURAZIONI FG 116 DA 2065MM

FG 116V/68A: Modulo armadietto
 FG 116/68V6: Cassettiera fissa a 6 cassetti
 FG 116V/68B: Armadietto, porta carta e porta rifiuti



CODICE	Dimensioni mm (LxPxH)	€/PZ
FG 116/CO6V	2065x490x2000	4.355,00

CODICE	Dimensioni mm (LxPxH)	€/PZ
FG 116/CO10V	2065x490x2000	3.535,00

CONFIGURAZIONI FG 116 DA 2.065mm + ARMADI

CONFIGURAZIONI FG 116 DA 2065MM + ARMADI

- FG 116V/68A: Modulo armadietto
- FG 116V/7G: Carrello porta utensili
- FG 116V/68B: Armadietto, porta carta e porta riuti
- FG 118/AR1V: Armadio alto - 2000x500x510mm



CODICE	Dimensioni mm (LxPxH)	€/PZ
FG 116/CO3V	2565x510x2000	5.025,00

CONFIGURAZIONI FG 116 DA 2065MM + ARMADI

- FG 116V/68A: Modulo armadietto
- FG 116V/7G: Carrello porta utensili a 7 cassetti
- FG 116V/68B: Armadietto, porta carta e porta riuti
- FG 118/AR1V: Armadio alto - 2000x500x510mm
- FG 118/AR2V: Armadio alto - 2000x1000x510mm



CODICE	Dimensioni mm (LxPxH)	€/PZ
FG 116/CO4V	3565x510x2000	6.125,00



CONFIGURAZIONI FG 116 DA 1.375mm

CONFIGURAZIONI FG 116 DA 1375MM

FG 116/68V6: Cassettiera fissa a 6 cassetti
 FG 116V/68B: Armadietto, porta carta e porta rifiuti



CONFIGURAZIONI FG 116 DA 1375MM

FG 116/68V6: Cassettiera fissa a 6 cassetti
 FG 116V/68B: Armadietto, porta carta e porta rifiuti



CODICE	Dimensioni mm (LxPxH)	€/PZ
FG 116/CO15V	1375x490x2000	3.060,00

CODICE	Dimensioni mm (LxPxH)	€/PZ
FG 116/CO14V	1375x490x2000	2.540,00

CONFIGURAZIONI FG 116 DA 1.375mm + ARMADIO

CONFIGURAZIONI FG 116 DA 1375MM + ARMADIO

FG 116V/68A: Modulo armadietto
 FG 116/68V5: Cassettiera fissa a 5 cassetti
 FG 118/AR1V: Armadio alto - 2000x500x510mm



CONFIGURAZIONI FG 116 DA 1375MM + ARMADIO

FG 116V/68A: Modulo armadietto
 FG 116/68V5: Cassettiera fissa a 5 cassetti
 FG 118/AR1V: Armadio alto - 2000x500x510mm



CODICE	Dimensioni mm (LxPxH)	€/PZ
FG 116/CO16V	1875x510x2000	3.505,00

CODICE	Dimensioni mm (LxPxH)	€/PZ
FG 116/CO17V	1875x510x2000	2.985,00

CONFIGURAZIONI FG 116 AD ANGOLO

CONFIGURAZIONI FG 116 AD ANGOLO

- FG 116V/68B: Armadietto, porta carta e porta rifiuti
- FG 116V/7G: Carrello porta utensili a 7 cassetti
- FG 116V/68A: Modulo armadietto
- FG 116/68V6: Cassettiera fissa a 6 cassetti
- FG 116V/68A: Modulo armadietto



CODICE	Dimensioni mm (LxPxH)	€/PZ
FG 116/CO30V	2566x490x2000 + 1885x490x2000	8.070,00

CONFIGURAZIONI FG 116 AD ANGOLO

- FG 116V/68B: Armadietto, porta carta e porta rifiuti
- FG 116V/7G: Carrello porta utensili a 7 cassetti
- FG 116V/68A: Modulo armadietto
- FG 116/68V6: Cassettiera fissa a 6 cassetti
- FG 116V/68A: Modulo armadietto
- FG 118/AR1V: Armadio alto - 2000x500x510mm
- FG 118/AR2V: Armadio alto - 2000x1000x510mm



CODICE	Dimensioni mm (LxPxH)	€/PZ
FG 116/CO32V	3066x510x2000 + 2885x510x2000	9.890,00



LA SOLUZIONE MODULARE PER
COMPORRE L'ARREDAMENTO TECNICO

in 2 facili STEP

1 STEP

PARTE SUPERIORE

SELEZIONARE LA STRUTTURA BASE
PER LA PARTE SUPERIORE:



CON PENSILI



SOLO GRIGLIA PORTAUTENSILI

2 STEP

MODULI

SELEZIONARE I MODULI
PER LA PARTE INFERIORE:



CARRELLO



DA 68



CASSETTIERA

FASANO
TOOLS

STRUTTURE BASE PER CONFIGURAZIONE DA 2065MM, DOTATA DI GRIGLIE PORTAUTENSILI E 3 PENSILI SUPERIORI



CODICE	Dimensioni mm (LxPxH)	€/PZ
FG 116V/207A	2065x490x2000	1.830,00

STRUTTURE BASE PER CONFIGURAZIONE DA 1375MM, DOTATA DI GRIGLIE PORTAUTENSILI E 2 PENSILI SUPERIORI



CODICE	Dimensioni mm (LxPxH)	€/PZ
FG 116V/138A	1375x490x2000	1.280,00

MODULO AD ANGOLO DOTATO DI 2 GRIGLIE PORTA UTENSILI

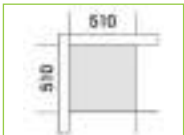

CODICE	Dimensioni mm (LxPxH)	€/PZ
FG 116/50AN	510x510x2000	950,00

STRUTTURE BASE PER CONFIGURAZIONE DA 2065MM, DOTATA DI GRIGLIE PORTAUTENSILI

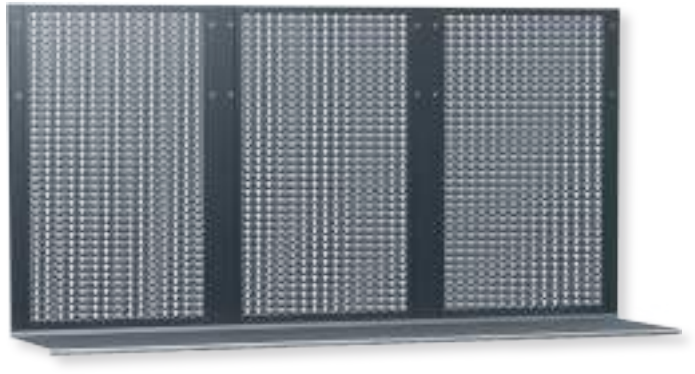

CODICE	Dimensioni mm (LxPxH)	€/PZ
FG 116/207B	2065x490x2000	1.040,00

STRUTTURE BASE PER CONFIGURAZIONE DA 1375MM, DOTATA DI GRIGLIE PORTAUTENSILI



CODICE	Dimensioni mm (LxPxH)	€/PZ
FG 116/138B	1375x490x2000	760,00

MODULO ARMADIETTO CON DOPPIA ANTINA DI APERTURA

Antine apribili a 120°
Ripiano interno amovibile
Dotato di serratura centrale



CODICE	Dimensioni mm (LxPxH)	Peso Kg	€/PZ
FG 116V/68A	680x460x992,5	34	715,00



MODULO ARMADIETTO CON 1 ANTINA + MODULO PORTA CARTA CON CASSETTO PORTA RIFIUTI

Antina apribile a 120°

Ripiano interno amovibile

Dotato di serratura di chiusura

Cassetto portarifiuti montato su guide telescopiche

Portata cassetto 35kg



CODICE	Dimensioni mm (LxPxH)	Peso Kg	€/PZ
FG 116V/68B	680x460x992,5	38	960,00

MODULO DISTRIBUZIONE ARIA COMPRESSA + MODULO PORTA CARTA CON CASSETTO PORTA RIFIUTI

Arrotolatore con tubo flessibile da 1/4", 15m

Cassetto portarifiuti montato su guide telescopiche

Portata cassetto 35 kg



CODICE	Dimensioni mm (LxPxH)	Peso Kg	€/PZ
FG 116V/68C	680x460x992,5	42	1.050,00

MODULO DISTRIBUZIONE ARIA COMPRESSA + ARMADIETTO

Arrotolatore con tubo flessibile da 1/4", 15m

Antina apribile a 120°

Ripiano interno amovibile

Dotato di serratura di chiusura



CODICE	Dimensioni mm (LxPxH)	Peso Kg	€/PZ
FG 116V/68D	680x460x992,5	41	930,00

MODULO DISTRIBUZIONE ARIA COMPRESSA + ENERGIA ELETTRICA

Arrotolatore con tubo flessibile da 1/4", 15m

Avvolgitore automatico 15m 3Gx1.5mm² con presa SHUCKO

CODICE	Dimensioni mm (LxPxH)	Peso Kg	€/PZ
FG 116M/68E	680x460x992,5	47	1.180,00

MODULO DISTRIBUZIONE ENERGIA ELETTRICA + MODULO PORTA CARTA CON CASSETTO PORTA RIFIUTIAvvolgitore automatico 15m 3Gx1.5mm² con presa SHUCKO

Cassetto portarifiuti montato su guide telescopiche

Portata cassetto 35 kg



CODICE	Dimensioni mm (LxPxH)	Peso Kg	€/PZ
FG 116V/68F	680x460x992,5	42	1.160,00

MODULO DISTRIBUZIONE ENERGIA ELETTRICA + MODULO ARMADIETTO 1 ANTINAAvvolgitore automatico 15m 3Gx1.5mm² con presa SHUCKO

Antina apribile a 120°

Ripiano interno amovibile

Dotato di serratura di chiusura



CODICE	Dimensioni mm (LxPxH)	Peso Kg	€/PZ
FG 116V/68G	680x460x992,5	41	1.040,00

CASSETTIERA FISSA A 5 CASSETTI

Guide telescopiche con sistema di aggancio automatico
Sistema di chiusura frontale centralizzata
Cassetti dotati di tappetino interno in gomma
Dimensione cassetti valida per inserimento moduli portautensili



CODICE	Dimensioni mm (LxPxH)	Peso Kg	€/PZ
FG 116/68V5	680x460x992,5	59	790,00

CASSETTIERA FISSA A 6 CASSETTI

Guide telescopiche con sistema di aggancio automatico
Sistema di chiusura frontale centralizzata
Cassetti dotati di tappetino interno in gomma
Dimensione cassetti valida per inserimento moduli portautensili



CODICE	Dimensioni mm (LxPxH)	Peso Kg	€/PZ
FG 116/68V6	680x460x992,5	58	820,00

CASSETTIERA FISSA A 7 CASSETTI

Guide telescopiche con sistema di aggancio automatico
Sistema di chiusura frontale centralizzata
Cassetti dotati di tappetino interno in gomma
Dimensione cassetti valida per inserimento moduli portautensili



CODICE	Dimensioni mm (LxPxH)	Peso Kg	€/PZ
FG 116/68V7	680x460x992,5	57	850,00

CASSETTIERA MOBILE A 5 CASSETTI

Guide telescopiche con sistema di aggancio automatico
Sistema di chiusura frontale centralizzata
Cassetti dotati di tappetino interno in gomma
Dimensione cassetti valida per inserimento moduli portautensili



CODICE	Dimensioni mm (LxPxH)	Peso Kg	€/PZ
FG 116V/5G	680x460x968,5	53	750,00

CASSETTIERA MOBILE A 6 CASSETTI

Guide telescopiche con sistema di aggancio automatico
Sistema di chiusura frontale centralizzata
Cassetti dotati di tappetino interno in gomma
Dimensione cassetti valida per inserimento moduli portautensili



CODICE	Dimensioni mm (LxPxH)	Peso Kg	€/PZ
FG 116V/6G	680x460x968,5	52	780,00

CASSETTIERA MOBILE A 7 CASSETTI

Guide telescopiche con sistema di aggancio automatico
Sistema di chiusura frontale centralizzata
Cassetti dotati di tappetino interno in gomma
Dimensione cassetti valida per inserimento moduli portautensili



CODICE	Dimensioni mm (LxPxH)	Peso Kg	€/PZ
FG 116V/7G	680x460x968,5	51	800,00



NUOVI MODULI ARREDAMENTO FURGONI



PIANO DA LAVORO IN LEGNO



BANCO DI LAVORO ESTRAIBILE
PORTAMORSA



PIANALI ANTISCIVOLO



Il lavoro on the road

Arredamento furgoni!

L'arredo tecnico Fasano Tools dedicato ai veicoli attrezzati
si adegua perfettamente a gusti ed esigenze.
Scegli il colore e la composizione ideale!



PALI FERMACARICO



ACCESSORI INDISPENSABILI



CASSETTI PREDISPOSTI PER
L'INSERIMENTO DEI MODULI
COMPLETI DI UTENSILI



CONFIGURAZIONE ARREDAMENTO TECNICO PER FURGONI

Comprende (dall'alto verso il basso)

FG 119/M30-40: coppie montanti laterali

FG 119/RP30-67: ripiano con divisori amovibili

FG 119/RV30-67: ripiano con vaschette in plastica

FG 119/M40-23: coppie montanti laterali

FG 119RV40-67: ripiano con vaschette in plastica

FG 119V/C73-3: cassetiera a 3 cassetti

FG 119/BA73: base aperta

FG 119/RI73: rialzo per basi aperte o chiuse



CODICE	Dimensioni mm (LxPxH)	Peso kg	€/PZ
FG 119V/CO1	735x400x1592	53,8	2.015,00
FG 119B/CO1	735x400x1592	53,8	2.015,00
FG 119R/CO1	735x400x1592	53,8	2.015,00

**CONFIGURAZIONE ARREDAMENTO TECNICO PER FURGONI**

Comprende (dall'alto verso il basso)

FG 119/M30-40: coppie montanti laterali

FG 119/RV30-67: ripiano con vaschette in plastica

FG 119/RP30-67: ripiano con divisori amovibili

FG 119/M40-23: coppie montanti laterali

FG 119/RP40-67: ripiano con divisori amovibili

FG 119V/C73-3: cassetiera a 3 cassetti

FG 119/BA73: base aperta

FG 119/RI73: rialzo per basi aperte o chiuse



CODICE	Dimensioni mm (LxPxH)	Peso kg	€/PZ
FG 119V/CO2	735x400x1592	53,2	2.020,00
FG 119B/CO2	735x400x1592	53,2	2.020,00
FG 119R/CO2	735x400x1592	53,2	2.020,00

**CONFIGURAZIONE ARREDAMENTO TECNICO PER FURGONI**

Comprende (dall'alto verso il basso)

FG 119/M30-40: coppie montanti laterali

FG 119/RP30-67: ripiano con divisori amovibili

FG 119/RV30-67: ripiano con vaschette in plastica

FG 119V/C73-3: cassetiera a 3 cassetti

FG 119/BA73: base aperta

FG 119/RI73: rialzo per basi aperte o chiuse



CODICE	Dimensioni mm (LxPxH)	Peso kg	€/PZ
FG 119V/CO3	735x400x1360	46,4	1.750,00
FG 119B/CO3	735x400x1360	46,4	1.750,00
FG 119R/CO3	735x400x1360	46,4	1.750,00



CONFIGURAZIONE ARREDAMENTO TECNICO PER FURGONI

Comprende (dall'alto verso il basso)

- FG 119/MRT30-9: coppie di montanti laterali
- FG 119/RV30-67: ripiano con vaschette in plastica
- FG 119V/C73-3: cassettera a 3 cassetti
- FG 119/BA73: base aperta
- FG 119/RI73: rialzo per basi aperte o chiuse



CODICE	Dimensioni mm (LxPxH)	Peso kg	€/PZ
FG 119V/CO4	735x400x1092	40,9	1.530,00
FG 119B/CO4	735x400x1092	40,9	1.530,00
FG 119R/CO4	735x400x1092	40,9	1.530,00



CONFIGURAZIONE ARREDAMENTO TECNICO PER FURGONI

Comprende (dall'alto verso il basso)

- FG 119/MRT40-9: coppie di montanti laterali
- FG 119/RP40-67: ripiano con divisori amovibili
- FG 119V/C73-3: cassettera a 3 cassetti
- FG 119/BA73: base aperta
- FG 119/RI73: rialzo per basi aperte o chiuse



CODICE	Dimensioni mm (LxPxH)	Peso kg	€/PZ
FG 119V/CO5	735x400x1057	42,2	1.570,00
FG 119B/CO5	735x400x1057	42,2	1.570,00
FG 119R/CO5	735x400x1057	42,2	1.570,00



CONFIGURAZIONE ARREDAMENTO TECNICO PER FURGONI

Comprende (dall'alto verso il basso)

- FG 119/MRT20-9 x 2: coppie di montanti laterali
- FG 119/RP20-67 x 2: ripiano con divisori amovibili
- FG 119V/C73-3: cassettera a 3 cassetti
- FG 119/BA73: base aperta
- FG 119/RI73: rialzo per basi aperte o chiuse



CODICE	Dimensioni mm (LxPxH)	Peso kg	€/PZ
FG 119V/CO6	735x400x1057	43,9	1.650,00
FG 119B/CO6	735x400x1057	43,9	1.650,00
FG 119R/CO6	735x400x1057	43,9	1.650,00



CONFIGURAZIONE ARREDAMENTO TECNICO PER FURGONI

Comprende (dall'alto verso il basso)

FG 119/M30-40: coppie montanti laterali

FG 119/RP30-92: ripiano con divisori amovibili

FG 119/RV30-92: ripiano con vaschette in plastica

FG 119/M40-23: coppie montanti laterali

FG 119/RV40-92: ripiano con vaschette in plastica

FG 119V/C49-3: cassetiera a 3 cassetti

FG 119V/C49-4: cassetiera a 4 cassetti

FG 119/BA98: base aperta

FG 119/RI98: rialzo per basi aperte o chiuse



CODICE	Dimensioni mm (LxPxH)	Peso kg	€/PZ
FG 119V/CO11	980x400x1592	75,6	2.900,00
FG 119B/CO11	980x400x1592	75,6	2.900,00
FG 119R/CO11	980x400x1592	75,6	2.900,00

**CONFIGURAZIONE ARREDAMENTO TECNICO PER FURGONI**

Comprende (dall'alto verso il basso)

FG 119/M30-40: coppie montanti laterali

FG 119/RV30-92: ripiano con vaschette in plastica

FG 119/RP30-92: ripiano con divisori amovibili

FG 119/M40-23: coppie montanti laterali

FG 119/RP40-92: ripiano con divisori amovibili

FG 119V/C49-3: cassetiera a 3 cassetti

FG 119V/C49-4: cassetiera a 4 cassetti

FG 119/BA98: base aperta

FG 119/RI98: rialzo per basi aperte o chiuse



CODICE	Dimensioni mm (LxPxH)	Peso kg	€/PZ
FG 119V/CO12	980x400x1592	74,9	2.920,00
FG 119B/CO12	980x400x1592	74,9	2.920,00
FG 119R/CO12	980x400x1592	74,9	2.920,00

**CONFIGURAZIONE ARREDAMENTO TECNICO PER FURGONI**

Comprende (dall'alto verso il basso)

FG 119/M30-40: coppie montanti laterali

FG 119/RP30-92: ripiano con divisori amovibili

FG 119/RP30-92: ripiano con divisori amovibili

FG 119/M40-23: coppie montanti laterali

FG 119/M40-40: coppie montanti laterali

FG 119/RP40-92: ripiano con divisori amovibili

FG 119/RP40-92: ripiano con divisori amovibili

FG 119/BV98-3: base con rialzo

CODICE	Dimensioni mm (LxPxH)	Peso kg	€/PZ
FG 119M/CO13	980x400x1592	40,4	1.540,00



CONFIGURAZIONE ARREDAMENTO TECNICO PER FURGONI

Comprende (dall'alto verso il basso)

- FG 119/M30-40: coppie montanti laterali
- FG 119/VP30-92: ripiano con divisori amovibili
- FG 119/RV30-92: ripiano con vaschette in plastica
- FG 119V/C49-3: cassetteria a 3 cassetti
- FG 119V/C49-4: cassetteria a 4 cassetti
- FG 119/BA98: base aperta
- FG 119/RI98: rialzo per basi aperte o chiuse



CODICE	Dimensioni mm (LxPxH)	Peso kg	€/PZ
FG 119V/CO14	980x400x1360	66,6	2.620,00
FG 119B/CO14	980x400x1360	66,6	2.620,00
FG 119R/CO14	980x400x1360	66,6	2.620,00

CONFIGURAZIONE ARREDAMENTO TECNICO PER FURGONI

Comprende (dall'alto verso il basso)

- FG 119/MRT30-9: coppie montanti laterali
- FG 119/RV30-92: ripiano con vaschette in plastica
- FG 119V/C49-3: cassetteria a 3 cassetti
- FG 119V/C49-4: cassetteria a 4 cassetti
- FG 119/BA98: base aperta
- FG 119/RI98: rialzo per basi aperte o chiuse



CODICE	Dimensioni mm (LxPxH)	Peso kg	€/PZ
FG 119V/CO15	980x400x1092	59,9	2.360,00
FG 119B/CO15	980x400x1092	59,9	2.360,00
FG 119R/CO15	980x400x1092	59,9	2.360,00

CONFIGURAZIONE ARREDAMENTO TECNICO PER FURGONI

Comprende (dall'alto verso il basso)

- FG 119/MRT40-9: coppie montanti laterali
- FG 119/VP40-92: ripiano con divisori amovibili
- FG 119V/C49-3: cassetteria a 3 cassetti
- FG 119V/C49-4: cassetteria a 4 cassetti
- FG 119/BA98: base aperta
- FG 119/RI98: rialzo per basi aperte o chiuse



CODICE	Dimensioni mm (LxPxH)	Peso kg	€/PZ
FG 119V/CO16	980x400x1057	61,8	2.400,00
FG 119B/CO16	980x400x1057	61,8	2.400,00
FG 119R/CO16	980x400x1057	61,8	2.400,00



CONFIGURAZIONE ARREDAMENTO TECNICO PER FURGONI

Comprende (dall'alto verso il basso)

- FG 119/MRT20-9 x 2: coppie di montanti laterali
- FG 119/RP20-92 x 2: ripiano con divisori amovibili
- FG 119V/C49-3: cassetiera a 3 cassetti
- FG 119V/C49-4: cassetiera a 4 cassetti
- FG 119/BA98: base aperta
- FG 119/RI98: rialzo per basi aperte o chiuse



CODICE	Dimensioni mm (LxPxH)	Peso kg	€/PZ
FG 119V/CO17	980x400x1057	63,6	2.500,00
FG 119B/CO17	980x400x1057	63,6	2.500,00
FG 119R/CO17	980x400x1057	63,6	2.500,00



CONFIGURAZIONE ARREDAMENTO TECNICO PER FURGONI

Comprende (dall'alto verso il basso)

- FG 119/M30-40: coppie di montanti laterali
- FG 119/RP30-116: ripiano con divisori amovibili
- FG 119/RV30-116: ripiano con vaschette in plastica
- FG 119/M40-23: coppie di montanti laterali
- FG 119/RV40-116: ripiano con vaschette in plastica
- FG 119V/C49-4: cassetiera a 4 cassetti
- FG 119V/C73-3 cassetiera a 3 cassetti
- FG 119/BA49: base aperta
- FG 119/BA73: base aperta
- FG 119/RI49: rialzo per basi aperte o chiuse
- FG 119/RI73: rialzo per basi aperte o chiuse



CODICE	Dimensioni mm (LxPxH)	Peso kg	€/PZ
FG 119V/CO21	1225x400x1592	92,4	3.470,00
FG 119B/CO21	1225x400x1592	92,4	3.470,00
FG 119R/CO21	1225x400x1592	92,4	3.470,00



CONFIGURAZIONE ARREDAMENTO TECNICO PER FURGONI

Comprende (dall'alto verso il basso)

- FG 119/M30-40: coppie di montanti laterali
- FG 119/RV30-116: ripiano con vaschette in plastica
- FG 119/RP30-116: ripiano con divisori amovibili
- FG 119/M40-23: coppie di montanti laterali
- FG 119/RP40-116: ripiano con divisori amovibili
- FG 119V/C49-4: cassetiera a 4 cassetti
- FG 119V/C73-3 cassetiera a 3 cassetti
- FG 119/BA49: base aperta
- FG 119/BA73: base aperta
- FG 119/RI49: rialzo per basi aperte o chiuse
- FG 119/RI73: rialzo per basi aperte o chiuse



CODICE	Dimensioni mm (LxPxH)	Peso kg	€/PZ
FG 119V/CO22	1225x400x1592	91,2	3.470,00
FG 119B/CO22	1225x400x1592	91,2	3.470,00
FG 119R/CO22	1225x400x1592	91,2	3.470,00



CONFIGURAZIONE ARREDAMENTO TECNICO PER FURGONI

Comprende (dall'alto verso il basso)
 FG 119/M30-40: coppie di montanti laterali
 FG 119/VP30-116: ripiano con divisori amovibili
 FG 119/RV30-116: ripiano con vaschette in plastica
 FG 119V/C49-4: cassetteria a 4 cassetti
 FG 119V/C73-3 cassetteria a 3 cassetti
 FG 119/BA49: base aperta
 FG 119/BA73: base aperta
 FG 119/RI49: rialzo per basi aperte o chiuse
 FG 119/RI73: rialzo per basi aperte o chiuse



CODICE	Dimensioni mm (LxPxH)	Peso kg	€/PZ
FG 119V/CO23	1225x400x1360	81,8	3.150,00
FG 119B/CO23	1225x400x1360	81,8	3.150,00
FG 119R/CO23	1225x400x1360	81,8	3.150,00



CONFIGURAZIONE ARREDAMENTO TECNICO PER FURGONI

Comprende (dall'alto verso il basso)
 FG 119/MRT30-9: coppie di montanti laterali
 FG 119/RV30-116: ripiano con vaschette in plastica
 FG 119V/C49-4: cassetteria a 4 cassetti
 FG 119V/C73-3 cassetteria a 3 cassetti
 FG 119/BA49: base aperta
 FG 119/BA73: base aperta
 FG 119/RI49: rialzo per basi aperte o chiuse
 FG 119/RI73: rialzo per basi aperte o chiuse



CODICE	Dimensioni mm (LxPxH)	Peso kg	€/PZ
FG 119V/CO24	1225x400x1092	74,1	2.890,00
FG 119B/CO24	1225x400x1092	74,1	2.890,00
FG 119R/CO24	1225x400x1092	74,1	2.890,00



CONFIGURAZIONE ARREDAMENTO TECNICO PER FURGONI

Comprende (dall'alto verso il basso)
 FG 119/MRT40-9: coppie di montanti laterali
 FG 119/VP40-116: ripiano con divisori amovibili
 FG 119V/C49-4: cassetteria a 4 cassetti
 FG 119V/C73-3 cassetteria a 3 cassetti
 FG 119/BA49: base aperta
 FG 119/BA73: base aperta
 FG 119/RI49: rialzo per basi aperte o chiuse
 FG 119/RI73: rialzo per basi aperte o chiuse



CODICE	Dimensioni mm (LxPxH)	Peso kg	€/PZ
FG 119V/CO25	1225x400x1057	76,2	2.930,00
FG 119B/CO25	1225x400x1057	76,2	2.930,00
FG 119R/CO25	1225x400x1057	76,2	2.930,00



CONFIGURAZIONE ARREDAMENTO TECNICO PER FURGONI

Comprende (dall'alto verso il basso)

FG 119/MRT20-9 x 2: coppie di montanti laterali

FG 119/RP20-116 x 2: ripiano con divisori amovibili

FG 119V/C49-4: cassetiera a 4 cassetti

FG 119V/C73-3: cassetiera a 3 cassetti

FG 119/BA49: base aperta

FG 119/BA73: base aperta

FG 119/RI49: rialzo per basi aperte o chiuse

FG 119/RI73: rialzo per basi aperte o chiuse



CODICE	Dimensioni mm (LxPxH)	Peso kg	€/PZ
FG 119V/CO26	1225x400x1057	78,3	3.050,00
FG 119B/CO26	1225x400x1057	78,3	3.050,00
FG 119R/CO26	1225x400x1057	78,3	3.050,00

**CONFIGURAZIONE ARREDAMENTO TECNICO PER FURGONI**

Comprende (dall'alto verso il basso)

FG 119/M30-40: coppie di montanti laterali

FG 119/RP30-141: ripiano con divisori amovibili

FG 119/RV30-141: ripiano con vaschette in plastica

FG 119/M40-23: coppie di montanti laterali

FG 119/RV40-141: ripiano con vaschette in plastica

FG 119V/C49-V1: cassetiera a 4 cassetti con valigia portaminuterie

FG 119V/C98-3: cassetiera a 3 cassetti

FG 119/BA98: base aperta

FG 119/C49-5B: base con 5 cassetti

FG 119/RI98: rialzo per basi aperte o chiuse



CODICE	Dimensioni mm (LxPxH)	Peso kg	€/PZ
FG 119V/CO31	1470x400x1592	126,2	4.500,00
FG 119B/CO31	1470x400x1592	126,2	4.500,00
FG 119R/CO31	1470x400x1592	126,2	4.500,00

**CONFIGURAZIONE ARREDAMENTO TECNICO PER FURGONI**

Comprende (dall'alto verso il basso)

FG 119/M30-40: coppie di montanti laterali

FG 119/RV30-141: ripiano con vaschette in plastica

FG 119/RP30-141: ripiano con divisori amovibili

FG 119/M40-23: coppie di montanti laterali

FG 119/RP40-141: ripiano con divisori amovibili

FG 119V/C49-V2: cassetiera a 4 cassetti con valigia portaminuterie

FG 119V/C98-3: cassetiera a 3 cassetti

FG 119/BA98: base aperta

FG 119/C49-5B: base con 5 cassetti

FG 119/RI98: rialzo per basi aperte o chiuse



CODICE	Dimensioni mm (LxPxH)	Peso kg	€/PZ
FG 119V/CO32	1470x400x1592	113,9	4.170,00
FG 119B/CO32	1470x400x1592	113,9	4.170,00
FG 119R/CO32	1470x400x1592	113,9	4.170,00



CONFIGURAZIONE ARREDAMENTO TECNICO PER FURGONI

Comprende (dall'alto verso il basso)

- FG 119/M30-40: coppie di montanti laterali
- FG 119/RP30-141: ripiano con divisori amovibili
- FG 119/RV30-141: ripiano con vaschette in plastica
- FG 119V/C49-V1: cassettera a 4 cassetti con valigia portaminuterie
- FG 119V/C98-3: cassettera a 3 cassetti
- FG 119/BA98: base aperta
- FG 119/C49-5B: base con 5 cassetti
- FG 119/RI98: rialzo per basi aperte o chiuse



CODICE	Dimensioni mm (LxPxH)	Peso kg	€/PZ
FG 119V/C033	1470x400x1360	114	4.170,00
FG 119B/C033	1470x400x1360	114	4.170,00
FG 119R/C033	1470x400x1360	114	4.170,00

CONFIGURAZIONE ARREDAMENTO TECNICO PER FURGONI

Comprende (dall'alto verso il basso)

- FG 119/MRT30-9: coppie di montanti laterali
- FG 119/RV30-141: ripiano con vaschette in plastica
- FG 119V/C49-V2: cassettera a 4 cassetti con valigia portaminuterie
- FG 119V/C98-3: cassettera a 3 cassetti
- FG 119/BA98: base aperta
- FG 119/C49-5B: base con 5 cassetti
- FG 119/RI98: rialzo per basi aperte o chiuse



CODICE	Dimensioni mm (LxPxH)	Peso kg	€/PZ
FG 119V/C034	1470x400x1092	94,1	3.530,00
FG 119B/C034	1470x400x1092	94,1	3.530,00
FG 119R/C034	1470x400x1092	94,1	3.530,00

CONFIGURAZIONE ARREDAMENTO TECNICO PER FURGONI

Comprende (dall'alto verso il basso)

- FG 119/MRT40-9: coppie di montanti laterali
- FG 119/RP40-141: ripiano con divisori amovibili
- FG 119V/C49-V2: cassettera a 4 cassetti con valigia portaminuterie
- FG 119V/C98-3: cassettera a 3 cassetti
- FG 119/BA98: base aperta
- FG 119/C49-5B: base con 5 cassetti
- FG 119/RI98: rialzo per basi aperte o chiuse



CODICE	Dimensioni mm (LxPxH)	Peso kg	€/PZ
FG 119V/C035	1470x400x1057	107,3	3.950,00
FG 119B/C035	1470x400x1057	107,3	3.950,00
FG 119R/C035	1470x400x1057	107,3	3.950,00



CONFIGURAZIONE ARREDAMENTO TECNICO PER FURGONI

Comprende (dall'alto verso il basso)

FG 119/MRT20-9 x 2: coppie di montanti laterali

FG 119/RP20-141 x 2: ripiano con divisori amovibili

FG 119V/C49-V2: cassettera a 4 cassetti con valigia portaminuterie

FG 119V/C98-3: cassettera a 3 cassetti

FG 119/BA98: base aperta

FG 119/C49-5B: base con 5 cassetti

FG 119/RI98: rialzo per basi aperte o chiuse



CODICE	Dimensioni mm (LxPxH)	Peso kg	€/PZ
FG 119V/CO36	1470x400x1057	98,9	3.700,00
FG 119B/CO36	1470x400x1057	98,9	3.700,00
FG 119R/CO36	1470x400x1057	98,9	3.700,00

**PIANO DI LAVORO IN LEGNO**

Multistrato pioppo



CODICE	Dimensioni mm (LxPxH)	Peso kg	€/PZ
FG 119/49TL	490x18x400	1,6	130,00
FG 119/73TL	735x18x400	2,4	220,00
FG 119/98TL	980x18x400	3,2	290,00



CONFIGURAZIONE ARREDAMENTO TECNICO PER FURGONI

Comprende (dall'alto verso il basso)
 FG 119/73TL: piano di lavoro in legno
 FG 119/C73-3: cassetiera a 3 cassetti
 FG 119/BA73: base aperta
 FG 119/RI73: rialzo per basi aperte o chiuse



CODICE	Dimensioni mm (LxPxH)	Peso kg	€/PZ
FG 119V/CO7	735x400x980	38,9	1.580,00
FG 119B/CO7	735x400x980	38,9	1.580,00
FG 119R/CO7	735x400x980	38,9	1.580,00



CONFIGURAZIONE ARREDAMENTO TECNICO PER FURGONI

Comprende (dall'alto verso il basso)
 FG 119/98TL: piano di lavoro in legno
 FG 119/C49-3: cassetiera a 3 cassetti
 FG 119/C49-4: cassetiera a 4 cassetti
 FG 119/BA98: base aperta
 FG 119/RI98: rialzo per basi aperte o chiuse



CODICE	Dimensioni mm (LxPxH)	Peso kg	€/PZ
FG 119V/CO18	980x400x980	56,5	2.460,00
FG 119B/CO18	980x400x980	56,5	2.460,00
FG 119R/CO18	980x400x980	56,5	2.460,00



CONFIGURAZIONE ARREDAMENTO TECNICO PER FURGONI

Comprende (dall'alto verso il basso)
 FG 119/73TL: piano di lavoro in legno
 FG 119/C49-4: cassetiera a 4 cassetti
 FG 119/C73-3: cassetiera a 3 cassetti
 FG 119/BA49: base aperta
 FG 119/BA73: base aperta
 FG 119/RI49: rialzo per basi aperte o chiuse
 FG 119/RI73: rialzo per basi aperte o chiuse



CODICE	Dimensioni mm (LxPxH)	Peso kg	€/PZ
FG 119V/CO27	1225x400x980	71,6	3.040,00
FG 119B/CO27	1225x400x980	71,6	3.040,00
FG 119R/CO27	1225x400x980	71,6	3.040,00



LA SOLUZIONE MODULARE PER COMPORRE
L'ARREDAMENTO DEL TUO FURGONE

in 3 facili STEP



STEP

BASE

1°

SELEZIONARE LA BASE:

- **APERTA** (SE POSIZIONATA SUL PASSARUOTA)
OPPURE **CHIUSA**
- **EVENTUALE RIALZO**



STEP

CASSETTI

2°

SELEZIONARE LA CASSETTIERA

(LA TIPOLOGIA ED IL NUMERO DELLE
CASSETTIERE VARIANO IN FUNZIONE
DELLA LARGHEZZA DELLA BASE)



STEP

RIPIANI

3°

AGGIUNGERE EVENTUALI RIPIANI
CON I RELATIVI MONTANTI LATERALI

(TENERE PRESENTE LA PROFONDITA' DELLA
STRUTTURA E LA SAGOMA DEL FURGONE)



RIALZO PER BASI APERTE O CHIUSE

CODICE	Dimensioni mm (LxPxH)	Peso kg	€/PZ
FG 119/RI49	490x400x166	2,4	50,00



RIALZO PER BASI APERTE O CHIUSE

CODICE	Dimensioni mm (LxPxH)	Peso kg	€/PZ
FG 119/RI73	735x400x166	2,8	55,00



RIALZO PER BASI APERTE O CHIUSE

CODICE	Dimensioni mm (LxPxH)	Peso kg	€/PZ
FG 119/RI98	980x400x166	3,2	65,00



BASE APERTA

CODICE	Dimensioni mm (LxPxH)	Peso kg	€/PZ
FG 119V/BA49	490x400x398	7,7	380,00
FG 119B/BA49	490x400x398	7,7	380,00
FG 119R/BA49	490x400x398	7,7	380,00



BASE APERTA

CODICE	Dimensioni mm (LxPxH)	Peso kg	€/PZ
FG 119V/BA73	735x400x398	9,6	410,00
FG 119B/BA73	735x400x398	9,6	410,00
FG 119R/BA73	735x400x398	9,6	410,00



BASE APERTA

CODICE	Dimensioni mm (LxPxH)	Peso kg	€/PZ
FG 119V/BA98	980x400x398	11,5	460,00
FG 119B/BA98	980x400x398	11,5	460,00
FG 119R/BA98	980x400x398	11,5	460,00





BASE CHIUSA

CODICE	Dimensioni mm (LxPxH)	Peso kg	€/PZ
FG 119V/BC49	490x400x398	10,7	430,00
FG 119B/BC49	490x400x398	10,7	430,00
FG 119R/BC49	490x400x398	10,7	430,00



BASE CHIUSA

CODICE	Dimensioni mm (LxPxH)	Peso kg	€/PZ
FG 119V/BC73	735x400x398	14,1	470,00
FG 119B/BC73	735x400x398	14,1	470,00
FG 119R/BC73	735x400x398	14,1	470,00



BASE CHIUSA

CODICE	Dimensioni mm (LxPxH)	Peso kg	€/PZ
FG 119V/BC98	735x400x398	17,5	540,00
FG 119B/BC98	980x400x398	17,5	540,00
FG 119R/BC98	980x400x398	17,5	540,00



BASE SENZA RIALZO

CODICE	Dimensioni mm (LxPxH)	Peso kg	€/PZ
FG 119/BV98	980x400x398	8,7	350,00

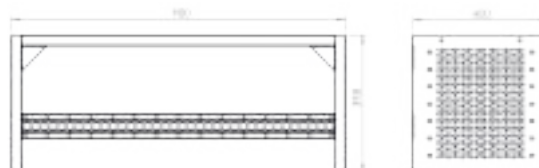

BASE CON RIALZO

CODICE	Dimensioni mm (LxPxH)	Peso kg	€/PZ
FG 119/BV98-2	980x400x564	11,9	410,00

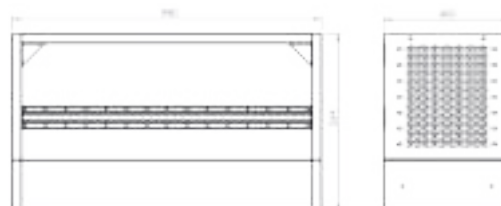



BASE CON RIALZO

CODICE	Dimensioni mm (LxPxH)	Peso kg	€/PZ
FG 119/BV98-3	980x400x564	10,2	340,00

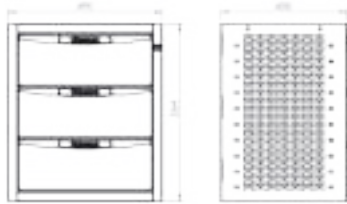
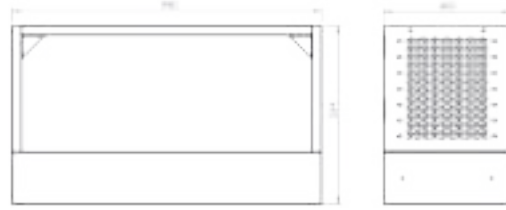

BASE CON 3 CASSETTI

CODICE	Dimensioni mm (LxPxH)	Peso kg	€/PZ
FG 119V/C49-3B	490x400x564	22,7	850,00
FG 119B/C49-3B	490x400x564	22,7	850,00
FG 119R/C49-3B	490x400x564	22,7	850,00

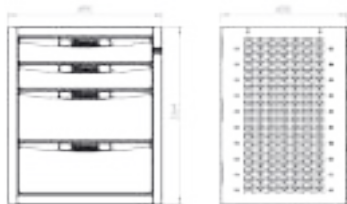

BASE CON 4 CASSETTI

CODICE	Dimensioni mm (LxPxH)	Peso kg	€/PZ
FG 119V/C49-4B	490x400x564	24,9	940,00
FG 119B/C49-4B	490x400x564	24,9	940,00
FG 119R/C49-4B	490x400x564	24,9	940,00

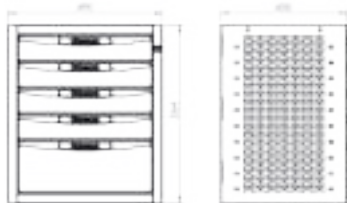

BASE CON 5 CASSETTI

CODICE	Dimensioni mm (LxPxH)	Peso kg	€/PZ
FG 119V/C49-5B	490x400x564	27,1	1.020,00
FG 119B/C49-5B	490x400x564	27,1	1.020,00
FG 119R/C49-5B	490x400x564	27,1	1.020,00





BASE CON 6 CASSETTI

CODICE	Dimensioni mm (LxPxH)	Peso kg	€/PZ
FG 119V/C49-6B	490x400x564	29,3	1.100,00
FG 119B/C49-6B	490x400x564	29,3	1.100,00
FG 119R/C49-6B	490x400x564	29,3	1.100,00



BASE CON 6 CASSETTI E VALIGIA PORTAMINUTERIE

CODICE	Dimensioni mm (LxPxH)	Peso kg	€/PZ
FG 119V/C49-VB	490x400x564	36,8	1.450,00
FG 119B/C49-VB	490x400x564	36,8	1.450,00
FG 119R/C49-VB	490x400x564	36,8	1.450,00



CASSETTIERA A 2 CASSETTI

CODICE	Dimensioni mm (LxPxH)	Peso kg	€/PZ
FG 119V/C49-2	490x400x398	16,6	630,00
FG 119B/C49-2	490x400x398	16,6	630,00
FG 119R/C49-2	490x400x398	16,6	630,00



CASSETTIERA A 3 CASSETTI

CODICE	Dimensioni mm (LxPxH)	Peso kg	€/PZ
FG 119V/C49-3	490x400x398	18,7	710,00
FG 119B/C49-3	490x400x398	18,7	710,00
FG 119R/C49-3	490x400x398	18,7	710,00



CASSETTIERA A 4 CASSETTI



CODICE	Dimensioni mm (LxPxH)	Peso kg	€/PZ
FG 119V/C49-4	490x400x398	20,9	800,00
FG 119B/C49-4	490x400x398	20,9	800,00
FG 119R/C49-4	490x400x398	20,9	800,00



CASSETTIERA A 4 CASSETTI CON VALIGETTE PORTAMINUTERIE

CODICE	Dimensioni mm (LxPxH)	Peso kg	€/PZ
FG 119V/C49-V1	490x400x398	26	1.030,00
FG 119B/C49-V1	490x400x398	26	1.030,00
FG 119R/C49-V1	490x400x398	26	1.030,00



CASSETTO CON APERTURA TOTALE



SISTEMA DI BLOCCAGGIO VALIGETTE



VALIGETTE INTERNE PORTA MINUTERIE



MODULO DOTATO DI 4 VALIGETTE PORTAMINUTERIE

CODICE	Dimensioni mm (LxPxH)	Peso kg	€/PZ
FG 119M/C49-V2	490x400x398	15,1	660,00

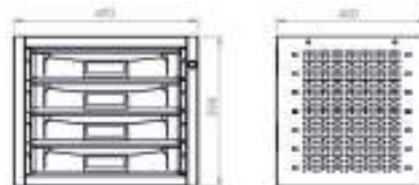

CASSETTO CON APERTURA TOTALE



CHIUSURA LATERALE CENTRALIZZATA



BOX INTERNI PORTA MINUTERIE





CASSETTIERA A 2 CASSETTI

CODICE	Dimensioni mm (LxPxH)	Peso kg	€/PZ
FG 119V/C73-2	735x400x398	21,2	700,00
FG 119B/C73-2	735x400x398	21,2	700,00
FG 119R/C73-2	735x400x398	21,2	700,00



FG 119B/C73-2



FG 119R/C73-2



CASSETTIERA A 3 CASSETTI

CODICE	Dimensioni mm (LxPxH)	Peso kg	€/PZ
FG 119V/C73-3	735x400x398	24,1	800,00
FG 119B/C73-3	735x400x398	24,1	800,00
FG 119R/C73-3	735x400x398	24,1	800,00



FG 119B/C73-3



FG 119R/C73-3

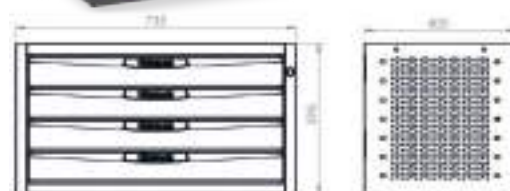

CASSETTIERA A 4 CASSETTI

CODICE	Dimensioni mm (LxPxH)	Peso kg	€/PZ
FG 119V/C73-4	735x400x398	27	900,00
FG 119B/C73-4	735x400x398	27	900,00
FG 119R/C73-4	735x400x398	27	900,00



FG 119B/C73-4



FG 119R/C73-4



CASSETTIERA A 2 CASSETTI

CODICE	Dimensioni mm (LxPxH)	Peso kg	€/PZ
FG 119V/C98-2	980x400x398	25,8	790,00
FG 119B/C98-2	980x400x398	25,8	790,00
FG 119R/C98-2	980x400x398	25,8	790,00



FG 119B/C98-2



FG 119R/C98-2



CASSETTIERA A 3 CASSETTI

CODICE	Dimensioni mm (LxPxH)	Peso kg	€/PZ
FG 119V/C98-3	980x400x398	29,5	900,00
FG 119B/C98-3	980x400x398	29,5	900,00
FG 119R/C98-3	980x400x398	29,5	900,00



FG 119B/C98-3



FG 119R/C98-3



CASSETTIERA A 4 CASSETTI

CODICE	Dimensioni mm (LxPxH)	Peso kg	€/PZ
FG 119V/C98-4	980x400x398	33,1	1.020,00
FG 119B/C98-4	980x400x398	33,1	1.020,00
FG 119R/C98-4	980x400x398	33,1	1.020,00

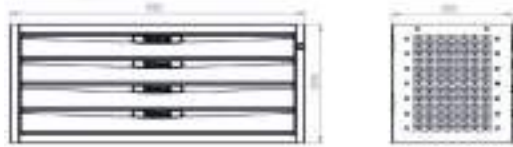

FG 119B/C98-4



FG 119R/C98-4



CASSETTIERA CON 4 VALIGETTE ESTRAIBILI E IMPILABILI

CODICE	Dimensioni mm (LxPxH)	Peso kg	€/PZ
FG 119M/C98-V	980x400x398	27	1.190,00

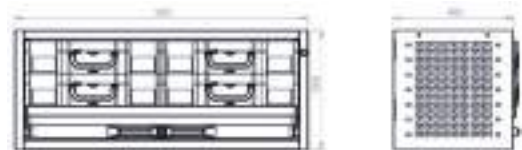

APERTURA TOTALE 4 VALIGETTE IMPILABILI



AGGANCIO VALIGETTA



BOX INTERNI PORTA MINUTERIE



RIPIANI CON DIVISORI AMOVIBILI



CODICE	N. divisori	Dimensioni mm (LxPxH)	Peso kg	€/PZ
FG 119/RP40-67	4 - FG 119/D40	670x400x95	5,1	130,00

RIPIANI CON DIVISORI AMOVIBILI



CODICE	N. divisori	Dimensioni mm (LxPxH)	Peso kg	€/PZ
FG 119/RP30-67	4 - FG 119/D30	670x400x95	4,1	110,00

RIPIANI CON DIVISORI AMOVIBILI



CODICE	N. divisori	Dimensioni mm (LxPxH)	Peso kg	€/PZ
FG 119/RP20-67	4 - FG 119/D20	670x400x95	3,1	85,00

RIPIANI CON DIVISORI AMOVIBILI



CODICE	N. divisori	Dimensioni mm (LxPxH)	Peso kg	€/PZ
FG 119/RP40-92	5 - FG 119/D40	920x400x95	6,6	160,00

RIPIANI CON DIVISORI AMOVIBILI

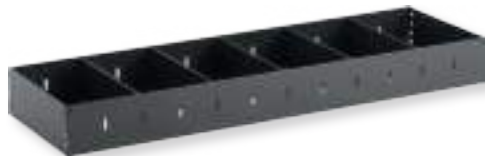

CODICE	N. divisori	Dimensioni mm (LxPxH)	Peso kg	€/PZ
FG 119/RP30-92	5 - FG 119/D30	920x400x95	5,3	140,00

RIPIANI CON DIVISORI AMOVIBILI



CODICE	N. divisori	Dimensioni mm (LxPxH)	Peso kg	€/PZ
FG 119/RP20-92	5 - FG 119/D20	920x400x95	4,1	120,00

RIPIANI CON DIVISORI AMOVIBILI



CODICE	N. divisori	Dimensioni mm (LxPxH)	Peso kg	€/PZ
FG 119/RP40-116	5 - FG 119/D40	1160x400x95	7,7	170,00

RIPIANI CON DIVISORI AMOVIBILI



CODICE	N. divisori	Dimensioni mm (LxPxH)	Peso kg	€/PZ
FG 119/RP30-116	5 - FG 119/D30	1160x400x95	6,3	150,00

RIPIANI CON DIVISORI AMOVIBILI



CODICE	N. divisori	Dimensioni mm (LxPxH)	Peso kg	€/PZ
FG 119/RP20-116	5 - FG 119/D20	1160x400x95	4,8	120,00

RIPIANI CON DIVISORI AMOVIBILI



CODICE	N. divisori	Dimensioni mm (LxPxH)	Peso kg	€/PZ
FG 119/RP40-141	6 - FG 119/D40	1410x400x95	9,2	200,00

RIPIANI CON DIVISORI AMOVIBILI



CODICE	N. divisori	Dimensioni mm (LxPxH)	Peso kg	€/PZ
FG 119/RP30-141	6 - FG 119/D30	1410x400x95	7,5	175,00

RIPIANI CON DIVISORI AMOVIBILI



CODICE	N. divisori	Dimensioni mm (LxPxH)	Peso kg	€/PZ
FG 119/RP20-141	6 - FG 119/D20	1410x400x95	5,8	140,00

RIPIANI CON VASCHEE IN PLASTICA



CODICE	N. vaschette	Dimensioni mm (LxPxH)	Peso kg	€/PZ
FG 119/RV40-67	3 - FG 119/VA40	670x400x1720	5,6	130,00

RIPIANI CON VASCHEE IN PLASTICA



CODICE	N. vaschette	Dimensioni mm (LxPxH)	Peso kg	€/PZ
FG 119/RV30-67	4 - FG 119/VA30	670x300x130	3,7	95,00

RIPIANI CON VASCHEE IN PLASTICA



CODICE	N. vaschette	Dimensioni mm (LxPxH)	Peso kg	€/PZ
FG 119/RV20-67	6 - FG 119/VA20	670x300x130	2,5	90,00

RIPIANI CON VASCHEE IN PLASTICA



CODICE	N. vaschette	Dimensioni mm (LxPxH)	Peso kg	€/PZ
FG 119/RV40-92	4 - FG 119/VA40	920x400x172	7,3	150,00

RIPIANI CON VASCHEE IN PLASTICA



CODICE	N. vaschette	Dimensioni mm (LxPxH)	Peso kg	€/PZ
FG 119/RV30-92	6 - FG 119/VA30	920x300x130	4,9	135,00

RIPIANI CON VASCHEE IN PLASTICA



CODICE	N. vaschette	Dimensioni mm (LxPxH)	Peso kg	€/PZ
FG 119/RV20-92	8 - FG 119/VA20	920x200x90	3,2	115,00

RIPIANI CON VASCHEE IN PLASTICA



CODICE	N. vaschette	Dimensioni mm (LxPxH)	Peso kg	€/PZ
FG 119/RV40-116	5 - FG 119/VA40	1160x400x172	8,9	180,00

RIPIANI CON VASCHEE IN PLASTICA



CODICE	N. vaschette	Dimensioni mm (LxPxH)	Peso kg	€/PZ
FG 119/RV30-116	7 - FG 119/VA30	1160x300x130	5,9	135,00

RIPIANI CON VASCHEE IN PLASTICA



CODICE	N. vaschette	Dimensioni mm (LxPxH)	Peso kg	€/PZ
FG 119/RV20-116	10 - FG 119/VA20	1160x200x90	3,9	125,00

RIPIANI CON VASCHEE IN PLASTICA



CODICE	N. vaschette	Dimensioni mm (LxPxH)	Peso kg	€/PZ
FG 119/RV40-141	6 - FG 119/VA40	1410x400x172	10,6	210,00

RIPIANI CON VASCHEE IN PLASTICA



CODICE	N. vaschette	Dimensioni mm (LxPxH)	Peso kg	€/PZ
FG 119/RV30-141	9 - FG 119/VA30	1410x300x130	7,1	160,00

RIPIANI CON VASCHEE IN PLASTICA



CODICE	N. vaschette	Dimensioni mm (LxPxH)	Peso kg	€/PZ
FG 119/RV20-141	12 - FG 119/VA20	1410x200x90	4,7	140,00





BOX PORTA MINUTERIA



CODICE	Dimensioni mm (LxPxH)	Portata Kg	Peso kg	€/PZ
FG 119/VA20	105x167x82	3,12	0,1	2,00

DIVISORE PER RIPIANI



CODICE	Dimensioni mm (LxH)	Peso kg	€/PZ
FG 119/D20	190x91	0,15	9,00

BOX PORTA MINUTERIA



CODICE	Dimensioni mm (LxPxH)	Portata Kg	Peso kg	€/PZ
FG 119/VA30	144x237x123	10,30	0,2	5,00

DIVISORE PER RIPIANI



CODICE	Dimensioni mm (LxH)	Peso kg	€/PZ
FG 119/D30	290x91	0,24	12,00

BOX PORTA MINUTERIA



CODICE	Dimensioni mm (LxPxH)	Portata Kg	Peso kg	€/PZ
FG 119/VA40	205x345x164	20,60	0,6	13,00

DIVISORE PER RIPIANI



CODICE	Dimensioni mm (LxH)	Peso kg	€/PZ
FG 119/D40	390x91	0,32	14,00

COPPIE DI MONTANTI LATERALI



CODICE	Dimensioni mm (LxH)	Peso kg	€/PZ
FG 119/M40-23	400x232	1,7	132,00

COPPIE DI MONTANTI LATERALI



CODICE	Dimensioni mm (LxH)	Peso kg	€/PZ
FG 119/M40-40	400x398	2,7	194,00

COPPIE DI MONTANTI LATERALI



CODICE	Dimensioni mm (LxH)	Peso kg	€/PZ
FG 119/M40-56	400x564	3,6	268,00

COPPIE DI MONTANTI LATERALI



CODICE	Dimensioni mm (LxH)	Peso kg	€/PZ
FG 119/M30-23	300x232	1,4	116,00

COPPIE DI MONTANTI LATERALI



CODICE	Dimensioni mm (LxH)	Peso kg	€/PZ
FG 119/M30-40	300x398	2,2	167,00

COPPIE DI MONTANTI LATERALI



CODICE	Dimensioni mm (LxH)	Peso kg	€/PZ
FG 119/M20-23	200x232	1,0	87,00

COPPIE DI MONTANTI LATERALI



CODICE	Dimensioni mm (LxH)	Peso kg	€/PZ
FG 119/M20-40	200x398	1,7	130,00

COPPIE DI MONTANTI LATERALI



CODICE	Dimensioni mm (LxH)	Peso kg	€/PZ
FG 119/MRT20-9	200x95	1,0	66,00

COPPIE DI MONTANTI LATERALI



CODICE	Dimensioni mm (LxH)	Peso kg	€/PZ
FG 119/MRT30-9	300x95	0,8	74,00

COPPIE DI MONTANTI LATERALI



CODICE	Dimensioni mm (LxH)	Peso kg	€/PZ
FG 119/MRT40-9	400x95	1,0	81,00



BANCO DA LAVORO



Leva per apertura e chiusura

Piano da lavoro estraibile

Leva di bloccaggio

CODICE	Dimensioni piano mm	Peso kg	€/PZ
FG 119/BL	810x250	22,3	850,00

BINARIO



CODICE	L/mm	€/PZ
FG 119/BIN178	178	16,00
FG 119/BIN330	330	21,00
FG 119/BIN483	483	25,00
FG 119/BIN635	635	32,00
FG 119/BIN787	787	36,00
FG 119/BIN940	940	55,00
FG 119/BIN3000	3000	92,00

BARRE DOPPIO PIANO



CODICE	L/mm	300	€/PZ
FG 119/BP1000	800-1000	300	140,00
FG 119/BP1300	950-1300	300	160,00
FG 119/BP1750	1250-1750	300	170,00

ROTAIA



CODICE	L/mm	€/PZ
FG 119/ROT3000	3000	125,00

BANCO DA LAVORO DOTATO DI MORSA 125MM CON BASE GIREVOLE



CODICE	Dimensioni piano mm	Peso kg	€/PZ
FG 119/PM	560x250	40,5	1.250,00

CINGHIE



CODICE	L/mm	Portata	€/PZ
FG 119/C75-A	0,75	1750	17,00
FG 119/C150-A	1,5	1750	21,00
FG 119/C100-B	1	4000	18,00
FG 119/C200-B	2	4000	18,00
FG 119/C100-C	1	7500	26,00
FG 119/C200-C	2	7500	33,00

ROTAIA



CODICE	L/mm	€/PZ
FG 119/ROL3000	3000	150,00

CINGHIE



CODICE	L/mm	Portata	€/PZ
FG 119/C400D	4	6750	32,00

PALI FERMACARICO



CODICE	L/mm	Portata	€/PZ
FG 119/PF1760	1160-1760	3000	190,00
FG 119/PF2300	1700-2300	3000	210,00

COPIA DI TERMINALI



CODICE	Portata	€/PZ
FG 119/TE1	4000	10,00
FG 119/TE2	11250	8,00

PALI COMBINATI



CODICE	L/mm	Portata	€/PZ
FG 119/PC1350	1050-1350	3500	160,00
FG 119/PC1600	1300-1600	3500	170,00
FG 119/PC1850	1550-1850	3500	190,00
FG 119/PC2100	1800-2100	3500	200,00

BICCHIERI COPRIFORO CON GANCIO FERMACARICO



CODICE	€/PZ
FG 119/IP1	6,50

TAPPI TERMINALI PER BINARI FG 119/BN



CODICE	€/PZ
FG 119/BIN-T	6,00



PIANALI IN LEGNO FENOLICO, 12MM

Il materiale con il quale sono prodotti i pianali è legno di Betulla spessore 12 mm, di colore grigio, rivestito con film fenolico ideale per essere utilizzato dove è richiesta un'alta resistenza all'usura. La superficie ha una speciale impronta antiscivolo, è resistente all'acqua, agli agenti atmosferici e alle sostanze chimiche.

Inoltre il prodotto è ecofriendly, igienico e semplice da pulire.

E' studiato per poter essere fornito in kit di montaggio a qualsiasi tipo di utenza e non richiedono attrezzature particolari.

Vengono forniti di serie con

- profili in alluminio per battute portiere posteriori e laterali
- ganci fermacarico e bicchieri copriforo.

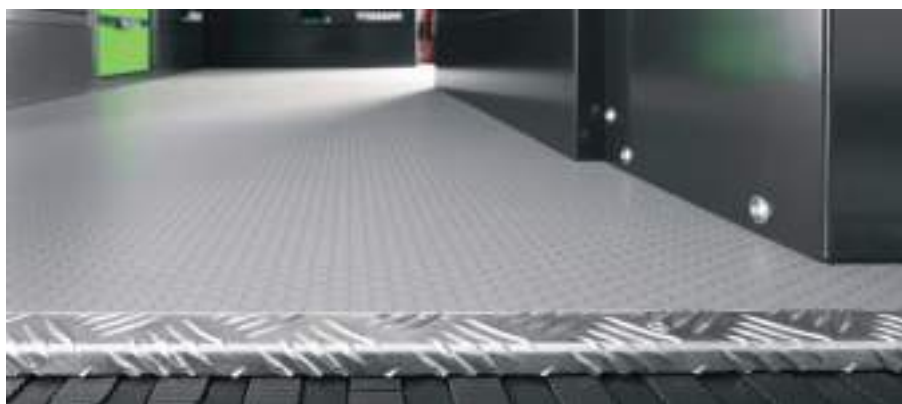

**INQUADRA CON LO SMARTPHONE IL QR CODE
E SCEGLI IL PIANALE
IN BASE AL MODELLO DEL TUO FURGONE**



RIVESTIMENTI IN POLIPROPILENE

PANNELLATURE IN PPL ALVEOLARE

Il rivestimento interno è indicato per evitare danni di carrozzeria causati dall'urto delle merci ed è facilmente installabile.

Il materiale utilizzato è il PPL (Polipropilene) alveolare di colore grigio e spessore 4 mm. I pannelli sono impermeabili, antigraffio e antimuffa.

Facili da pulire e resistenti alle alte temperature, ad acqua e olio.



**INQUADRA CON LO SMARTPHONE IL QR CODE
E SCEGLI IL RIVESTIMENTO
IN BASE AL MODELLO DEL TUO FURGONE**





Moduli in Gomma (Eva Foam)

Organizza i tuoi utensili con i nostri moduli in gomma, da assemblare e modulare a tua scelta, in base alle dimensioni del cassetto.

Ordine e funzionalità per il tuo lavoro!

Il Sistema modulare ti permette di personalizzare l'allestimento furgoni a seconda delle tue necessità per rendere più funzionale e veloce il tuo lavoro.

COMPONI IL TUO CASSETTO

Cassetto l/mm 49

1/3
1/3

1/3	
1/6	1/6

2/3

1/2
1/6A

Cassetto l/mm 73

1/3	1/6
1/3	1/6

1/3	1/6	
1/6	1/6	1/6

2/3	1/6
	1/6

1/2	1/6
1/6A	1/6

Cassetto l/mm 98

1/3	1/3
1/3	1/3

2/3	2/3
-----	-----

2/3	1/3
	1/3

1/2	1/6	1/6
1/6A	1/6	1/6







17

PROFESSIONAL EQUIPMENT



FASANO
PROFESSIONAL EQUIPMENT



**SMONTA
AMMORTIZZATORI**

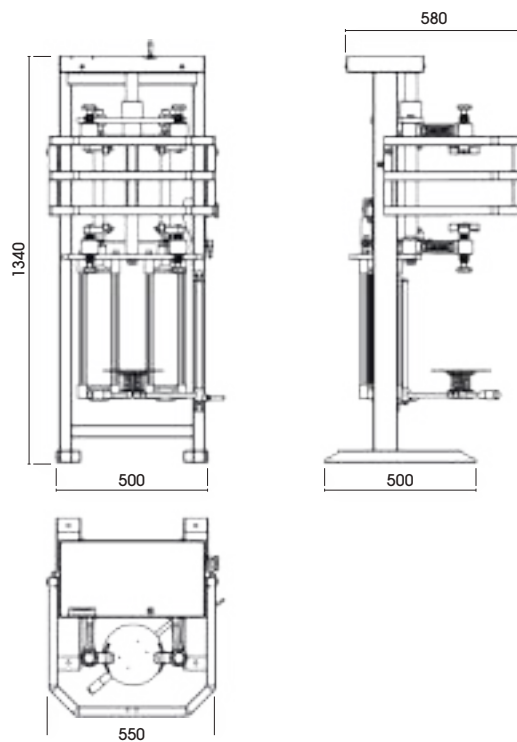

MADE IN ITALY

SMONTA-AMMORTIZZATORI DOTATO DI 1 PISTONE

Potenza spinta: 1.2 ton (10 bar) - 0.9 ton (8 bar)
Corsa di compressione molla: 300mm



SMONTA-AMMORTIZZATORI DOTATO DI 2 PISTONI

Potenza spinta: 2.4 ton (10 bar) - 1.9 ton (8 bar)
Corsa di compressione molla: 300mm



CODICE	Capacità kg	€/PZ
FG 750/1P	1200	2.600,00

CODICE	Capacità kg	€/PZ
FG 750/2P	2400	3.300,00

SMONTA-AMMORTIZZATORI DOTATO DI 1 PISTONE E DISPLAY DIGITALE

Il display digitale visualizza la pressione applicata durante la fase di utilizzo



CODICE	Capacità kg	€/PZ
FG 752/1P	1200	3.400,00

SMONTA-AMMORTIZZATORI DOTATO DI 2 PISTONI E DISPLAY DIGITALE

Il display digitale visualizza la pressione applicata durante la fase di utilizzo



CODICE	Capacità kg	€/PZ
FG 752/2P	2400	4.100,00

CAVALLETTO SOSTEGNO MOTORE RICHIUDIBILE

Versione richiudibile

Possibilità di rotazione a 360°

Ruote in acciaio per una maggiore durata e capacità



Sistema di rotazione a 360° a manovella

CODICE	Capacità kg	L1/mm	L2/mm	€/PZ
FG 745/CMR	560	995	585	950,00

CAVALLETTO SOSTEGNO MOTORE

Possibilità di rotazione a 360°

Ruote in acciaio per una maggiore durata e capacità



Sistema di rotazione a 360°

CODICE	Capacità kg	L1/mm	L2/mm	€/PZ
FG 745/CMF	560	860	725	460,00





SOLLEVATORI IDRAULICI



Sollevamento tramite manico



Robusta struttura in metallo



4 ruote in nylon

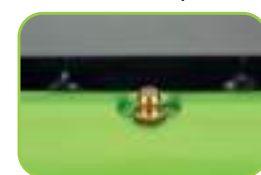

valvola di spurgo dell'aria

SOLLEVATORE IDRAULICO 2T MODELLO LUNGO E RIBASSATO

Design ribassato, ideale per lavorare anche su veicoli con bassa altezza da terra
 Versione lunga
 Sollevamento tramite manico con gomma antiurto
 Robusta struttura in acciaio
 Velocità di discesa controllata
 4 ruote in nylon
 Valvola di spurgo dell'aria



SOLLEVATORE IDRAULICO 2.5T MODELLO CORTO

Robusta struttura in acciaio
 Velocità di discesa controllata
 Manico con gomma antiurto
 4 ruote in nylon
 Valvola di spurgo dell'aria



CODICE	Peso kg	H-min/max mm	€/PZ
FG 719/2T	43.5	75-610	740,00

CODICE	Peso kg	H-min/max mm	€/PZ
FG 718/2.5T	30	75-510	470,00

SOLLEVATORE IDRAULICO 3.5T MODELLO CORTO E RIBASSATO

Design ribassato, ideale per lavorare su veicoli con bassa altezza da terra
Portata elevata per utilizzo anche su fuoristrada e furgoni
Robusta struttura in acciaio
Velocità di discesa controllata
Manico con gomma antiurto
4 ruote in nylon
Valvola di spurgo dell'aria



CODICE	Peso kg	H-min/max mm	€/PZ
FG 718/3.5T	39	95-540	560,00

SOLLEVATORE IDRAULICO A CARRELLO 5T MODELLO LUNGO PER MEZZI PESANTI

Sistema di sollevamento ausiliario a pedale
Ruote in acciaio montate su cuscinetti a sfera
Self-return integrato



CODICE	€/PZ
FG 722/5T	1.420,00

GRU IDRAULICA PIEGHEVOLE

Versione richiudibile
Ruote in acciaio per una maggiore durata e capacità



CODICE	Capacità kg	H-min/max mm	L1/mm	L2/mm	€/PZ
FG 738/1T	1000	94-2300	1470	800	1.100,00

COPIA DI COLONNETTE DI SOSTEGNO



CODICE	Capacità kg	H-min/max mm	€/PZ
FG 725/3T	3000	285-425	95,00
FG 725/6T	6000	390-605	160,00
FG 725/12T	12000	495-720	280,00

SOLLEVATORI IDRAULICI A BOTTIGLIA



CODICE	Capacità kg	H-min/max mm	€/PZ
FG 735/4T	4000	193-373	85,00
FG 735/6T	6000	210-416	98,00
FG 735/10T	10000	230-460	140,00
FG 735/16T	16000	230-440	160,00
FG 735/20T	20000	242-452	200,00



CARRELLO MOVIMENTAZIONE VEICOLI

Sistema di sollevamento a pedale
Dotato di 4 ruote girevoli

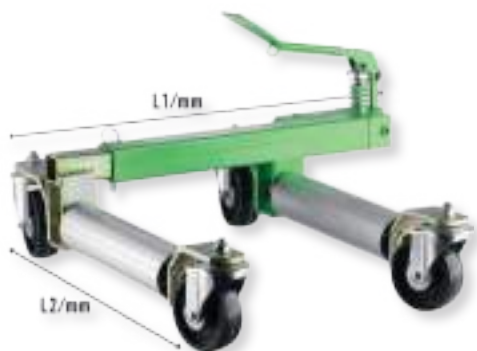

CODICE	Capacità kg	L1/mm	L2/mm	€/PZ
FG 750/A	680	550	620	420,00

SUPPORTO SOSTEGNO MOTORE

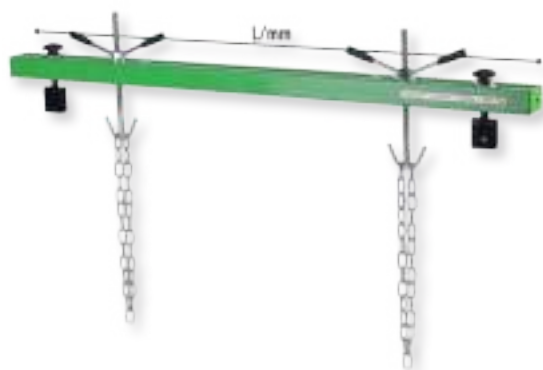

CODICE	Capacità kg	L/mm	€/PZ
FG 748/0.5T	500	1550	250,00

TRAVERSA SOSTEGNO MOTORE INFERIORE

Utile per il sostenimento del motore o del cambio durante i lavori di manutenzione sia di autovetture che di veicoli commerciali



Asta estensibile per facilitare l'uso anche su veicoli con culle del cambio particolarmente larghe

CODICE	L/mm	€/PZ
FG 213/SM	1050	750,00



TRAVERSA SOSTEGNO MOTORE INFERIORE

Utile per il sostenimento del motore o del cambio durante i lavori di manutenzione sia di autovetture che di veicoli commerciali



Asta estensibile per facilitare l'uso anche su veicoli con culle del cambio particolarmente larghe

CODICE	L/mm	€/PZ
FG 213/SM1	1100	590,00

SOLLEVATORE IDRAULICO DA FOSSA E SOTTOPONTE

Sistema di sollevamento a pedale
Dotato di 4 ruote girevoli



CODICE	Capacità kg	H-min/max mm	€/PZ
FG 740/0.5T	500	934-1864	600,00

SUPPORTO UNIVERSALE PER CAMBI E FRIZIONI

Dotato di adattatore per stelo sollevatore Ø 25-30-35-45 mm
Idoneo per autovetture e veicoli commerciali



CODICE	€/PZ
FG 213/SU	630,00

LEVA PER ESTRAZIONE TESTINE BRACCIO OSCILLANTE E AMMORTIZZATORI



CODICE	L/mm	€/PZ
FG 213/LT	750	310,00

SEGGIOLINO GIREVOLE, DOTATO DI ACCESSORI

2 cassetti dotati di guide telescopiche
Accessorio porta lattina in plastica antiurto
Seduta imbottita e rivestita in PVC



CODICE	€/PZ
FG 710/C	150,00

SEGGIOLINO GIREVOLE, DOTATO DI ACCESSORI

Ampio cassetto montato su guide telescopiche
Dotato di accessori porta minuterie e porta lattine facilmente amovibili



CODICE	€/PZ
FG 710/D	245,00

LETTINO SOTTO MACCHINA RICHIUDIBILE

Ripiegabile e trasportabile
6 ruote girevoli da 65 mm
Struttura in acciaio e corpo imbottito rivestito in PVC



CODICE	Dimensioni mm aperto	Dimensioni mm chiuso	Load kg	€/PZ
FG 710/B	910x415x120	540x415x150	136	120,00

LETTINO SOTTO MACCHINA IN PLASTICA ANTI-URTO

6 ruote girevoli

NEW



CODICE	Dimensioni mm	€/PZ
FG 710/E	1000x470x130	150,00



CODICE	PAGINA	€/Pz
FG/XTV	325	120,00
FG/XT V2	325	120,00
FG/XTP1	326	140,00
FG/EBV	326	40,00
FG GA/80	391	1,00
FG GA/120	391	1,20
FG GA/T	391	1,30
FG 20/A2	316	56,00
FG 20/AD4	316	5,00
FG 20/AD4.75	316	5,00
FG 20/AD6	316	5,00
FG 20/AD8	316	5,00
FG 20/AD10	316	5,00
FG 20/AD12	316	5,00
FG 20/AD14	316	5,00
FG 21/S10	317	145,00
FG 21/CD	317	31,00
FG 21/CS	317	55,00
FG 21/CR	317	38,00
FG 22/2.5x60	84	5,30
FG 22/2.5x75	84	5,30
FG 22/3x75	84	5,30
FG 22/3x100	84	5,50
FG 22/3.5x100	84	5,70
FG 22/3.5x125	84	5,80
FG 22/4x100	84	6,00
FG 22/4x125	84	6,20
FG 22/4x150	84	6,30
FG 22/5.5x100	84	6,60
FG 22/5.5x150	84	7,70
FG 22/5.5x200	84	7,70
FG 22/6.5x100	84	8,20
FG 22/6.5x150	84	8,50
FG 22/8x150	84	11,10
FG 22/8x200	84	12,70
FG 22/10x200	84	15,00
FG 22/12x250	84	15,70
FG 22/4x30	84	6,40
FG 22/6.5x30	84	6,60
FG 22SL/S5	84	36,00
FG 22SL/S9	84	78,00
FG 22SL/S12	84	105,00
FG 22/PH0x60	84	5,30
FG 22/PH1x80	84	6,80
FG 22/PH1x150	84	6,90
FG 22/PH1x200	84	8,00
FG 22/PH2x100	84	8,40
FG 22/PH2x150	84	9,00
FG 22/PH2x200	84	9,50
FG 22/PH3x150	84	11,40
FG 22/PH4x200	84	14,70
FG 22/PH1x30	84	6,30
FG 22/PH2x30	84	6,70
FG 22PH/S4	85	35,70
FG 22PH/S6	85	56,70
FG 22PH/S8	85	71,40
FG 22/PZ0x60	85	5,60
FG 22/PZ1x80	85	6,80
FG 22/PZ2x100	85	8,00
FG 22/PZ3x150	85	11,60
FG 22/PZ4x200	85	14,30
FG 22/PZ1x30	85	6,30
FG 22/PZ2x30	85	6,50
FG 22PZ/S4	85	34,70
FG 22PZ/S5	85	49,40
FG 22PZ/S7	85	63,00
FG 22/S6	85	36,00

CODICE	PAGINA	€/Pz
FG 22/S8	85	48,00
FG 22/S8B	85	52,00
FG 22/S10	85	65,00
FG 22/S12	85	90,00
FG 22/S7	86	50,00
FG 22/5.5x125H	86	6,70
FG 22/6.5x150H	86	8,80
FG 22/8x175H	86	10,90
FG 22/10x200H	86	13,40
FG 22/12x200H	86	15,00
FG 22/PH2x100H	86	10,00
FG 22/PH3x150H	86	11,60
FG 22/PH4x200H	86	15,30
FG 22/S8H	86	95,00
FG 22/2.5x200	86	7,70
FG 22/2.5x300	86	9,20
FG 22/4x400	86	11,60
FG 22/5x400	86	13,40
FG 22/6x400	86	16,70
FG 22/PH0x300	86	8,40
FG 22/PH1x400	86	12,60
FG 22/PH2x400	86	15,30
FG 22XL/S6	87	70,40
FG 22XL/S8	87	96,60
FG 22/OF4	87	5,10
FG 22/OF5	87	5,60
FG 22/OF8	87	7,90
FG 22/PH12	87	5,70
FG 22/PH34	87	10,80
FG 22/H2	87	6,30
FG 22/H2.5	87	6,50
FG 22/H3	87	6,60
FG 22/H4	87	7,40
FG 22/H5	87	8,40
FG 22/H6	87	9,50
FG 22/H8	87	12,10
FG 22H/S7	87	57,80
FG 22/TX6	87	7,20
FG 22/TX7	87	7,20
FG 22/TX8	87	8,40
FG 22/TX9	87	8,40
FG 22/TX10	87	9,80
FG 22/TX15	87	9,80
FG 22/TX20	87	9,80
FG 22/TX25	87	11,10
FG 22/TX27	87	11,10
FG 22/TX30	87	11,10
FG 22/TX40	87	12,60
FG 22/TX45	87	14,20
FG 22TX/S6	87	65,00
FG 22TX/S8	88	90,30
FG 22TX/S12	88	120,80
FG 22/RTX6	88	9,10
FG 22/RTX7	88	9,10
FG 22/RTX8	88	9,10
FG 22/RTX9	88	9,10
FG 22/RTX10	88	9,90
FG 22/RTX15	88	10,20
FG 22/RTX20	88	10,50
FG 22/RTX25	88	10,90
FG 22/RTX27	88	11,20
FG 22/RTX30	88	12,10
FG 22/RTX40	88	12,50
FG 22/RTX45	88	14,20
FG 22RTX/S6	88	69,30
FG 22RTX/S8	88	94,50
FG 22RTX/S12	88	132,00

CODICE	PAGINA	€/Pz
FG 22XL/TX6	88	11,70
FG 22XL/TX7	88	11,70
FG 22XL/TX8	88	11,70
FG 22XL/TX9	88	11,70
FG 22XL/TX10	88	14,20
FG 22XL/TX15	88	14,20
FG 22XL/TX20	88	14,20
FG 22XL/TX25	88	17,80
FG 22XL/TX27	88	17,80
FG 22XL/TX30	88	17,80
FG 22XL/TX40	88	17,80
FG 22TX/LS8	88	122,00
FG 22TX/LS11	88	155,00
FG 22/FL5	89	21,70
FG 22/FL5.5	89	21,70
FG 22/FL6	89	21,70
FG 22/FL7	89	21,70
FG 22/FL8	89	21,70
FG 22/FL10	89	21,70
FG 22FL/S6	89	132,00
FG 22/FX5	89	12,60
FG 22/FX5.5	89	12,60
FG 22/FX6	89	12,60
FG 22/FX7	89	14,20
FG 22/FX8	89	14,20
FG 22/FX9	89	14,20
FG 22/FX10	89	15,30
FG 22/FX11	89	15,30
FG 22/FX12	89	15,30
FG 22/FX13	89	16,80
FG 22FX/S6	89	89,80
FG 22FX/S9B	89	131,80
FG 22FX/S10	89	147,00
FG 22E/2.5x75	116	8,30
FG 22E/3x100	116	8,50
FG 22E/4x100	116	9,30
FG 22E/5.5x125	116	10,90
FG 22E/6.5x150	116	11,40
FG 22E/8x175	116	12,40
FG 22E/PH0x60	116	8,30
FG 22E/PH1x80	116	9,30
FG 22E/PH2x100	116	10,30
FG 22E/PH3x150	116	11,40
FG 22E/PZ0x60	116	8,30
FG 22E/PZ1x80	116	9,10
FG 22E/PZ2x100	116	9,80
FG 22E/PZ3x150	116	11,40
FG 22E/SL6	116	63,90
FG 22E/SH4	116	47,40
FG 22E/SZ4	116	47,40
FG 22E/S6	116	58,00
FG 22E/SZ6	117	58,00
FG 22/CF24	117	9,50
FG 22/CF250	117	7,90
FG 23/I	101	44,10
FG 23/S28	101	157,50
FG 24/CU1	317	40,00
FG 24/CU2	317	40,00
FG 30/GA1	316	30,00
FG 30/GA1.5	316	40,00
FG 30/GA2	316	48,00
FG 30/GA2B	316	56,00
FG 30/GA2.5	316	82,00
FG 30/GA3	316	125,00
FG 32/GP1	316	32,00
FG 32/GP1.5	316	45,00
FG 32/GP2	316	70,00

CODICE	PAGINA	€/Pz
FG 32/GS1	316	32,00
FG 32/GS1.5	316	45,00
FG 32/GS2	316	70,00
FG 33/GA2	316	70,00
FG 33/GA2.5	316	98,00
FG 33/GA3	316	148,00
FG 33/GA5	316	298,00
FG 34/GL1	316	20,00
FG 34/GL1.5	316	25,00
FG 35/E250	112	98,00
FG 35/B1	317	20,00
FG 35/B2	317	20,50
FG 35/B3	317	25,50
FG 35/B4	317	32,00
FG 35/B5	317	41,00
FG 35/1	317	19,00
FG 36/1	32	28,00
FG 36/2	32	31,50
FG 36/3	32	42,50
FG 36/4	32	57,00
FG 36/5	32	76,00
FG 37/1	33	28,50
FG 37/2	33	34,00
FG 37/3	33	44,50
FG 37/4	33	61,00
FG 37/5	33	78,00
FG 37/1R	33	6,00
FG 37/2R	33	7,00
FG 37/3R	33	9,50
FG 37/4R	33	12,50
FG 37/5R	33	15,00
FG 38/1	33	9,00
FG 38/2	33	11,00
FG 38/3	33	11,00
FG 38/4	33	13,00
FG 38/5	33	13,00
FG 38/6	33	16,50
FG 38/7	33	16,50
FG 38/8	33	19,50
FG 38/9	33	19,50
FG 38/10	33	26,00
FG 38/11	33	26,00
FG 38/12	33	38,00
FG 38/13	33	44,00
FG 38/14	33	60,00
FG 38/15	33	60,00
FG 38/16	33	78,00
FG 43/MT3	164	7,30
FG 43/MT5	164	9,30
FG 44/MT3	164	11,50
FG 44/MT5	164	18,00
FG 44/MT8	164	24,00
FG 44/MT10	164	29,00
FG 45/MT10	165	11,00
FG 45/MT20	165	12,00
FG 46/FR2	165	7,00
FG 47/S4	301	21,50
FG 47/P1	302	18,50
FG 47/P2	302	18,50
FG 47/P3	302	18,50
FG 47/S3	302	58,00
FG 48/IS	119	24,80
FG 48/B	140	21,70
FG 48/K12	140	8,50
FG 48/P	140	10,30
FG 48/PL	140	6,70
FG 48/L9	140	7,30

CODICE	PAGINA	€/Pz
FG 48/KL9	140	6,20
FG 48/L	140	9,30
FG 48/KL10	140	6,20
FG 48/LG	140	9,30
FG 48/KL10	140	6,20
FG 49/E	119	41,50
FG 49/TC	140	41,00
FG 49/TCX	141	48,00
FG 49	141	16,50
FG 49/L	141	18,00
FG 49/MU	141	26,50
FG 49/HE200	141	22,00
FG 49/HE250	141	25,80
FG 49/HE300	141	32,00
FG 49/HE350	141	40,00
FG 49/CS	141	27,50
FG 49/CL	141	27,50
FG 49/CR	141	27,50
FG 50/ME	142	38,00
FG 50/SE	142	26,50
FG 50/PE	142	17,50
FG 50/MS	142	7,50
FG 50/MN	142	12,00
FG 50/MN-B	142	6,50
FG 50/MI	142	8,50
FG 50/AR	142	13,50
FG 50/MSL	142	10,50
FG 50/MIL	142	15,00
FG 50/LBM	142	27,00
FG 51/140	106	23,10
FG 51/180	106	23,70
FG 51/230	106	33,10
FG 51/310	106	46,80
FG 51/S4	107	99,80
FG 51/S4B	107	105,00
FG 52/140	106	24,20
FG 52/180	106	26,30
FG 52/230	106	32,10
FG 52/310	106	46,80
FG 53/140	107	23,10
FG 53/180	107	23,70
FG 53/230	107	33,10
FG 53/310	107	46,80
FG 54/140	107	24,20
FG 54/180	107	26,30
FG 54/230	107	32,10
FG 54/310	107	46,80
FG 55/140	107	33,60
FG 55/180	107	34,70
FG 55/S4	107	136,50
FG 55/S4B	107	141,80
FG 55/SP	108	47,30
FG 56/0	106	29,40
FG 56/45	106	29,40
FG 56/90	106	29,40
FG 56/S3	106	89,30
FG 56/140	107	33,60
FG 56/180	107	34,70
FG 57/0	106	38,00
FG 57/45	106	38,00
FG 57/90	106	38,00
FG 57/S3	106	116,00
FG 57/140	107	33,60
FG 57/180	107	34,70
FG 58/A240	106	42,00
FG 58/B180	106	29,00
FG 58/B240	106	33,50

CODICE	PAGINA	€/Pz
FG 58/B300	106	47,00
FG 58/400	106	54,50
FG 58/140	107	33,60
FG 58/180	107	34,70
FG 58/IS250	119	55,70
FG 59/XT160	102	23,10
FG 59/XT180	102	28,40
FG 59/XT200	102	32,60
FG 59/HL160	102	26,80
FG 59/HL180	102	29,90
FG 59/HL200	102	35,10
FG 59/HL225	102	37,10
FG 59XT/S3	103	89,50
FG 59XT/S3B	103	99,50
FG 59SR/160	104	21,60
FG 59SR/180	104	29,40
FG 59SR/200	104	30,00
FG 59SR/S3	104	86,10
FG 59SR/S3B	104	96,60
FG 59PV/160	105	20,50
FG 59PV/180	105	22,10
FG 59PV/200	105	25,20
FG 59PV/S3	105	72,00
FG 59PV/S3B	105	79,00
FG 59/IS180	118	38,70
FG 59/IS200	118	41,20
FG 59IS/S3	119	118,50
FG 60/XT160	102	31,00
FG 60/XT200	102	35,00
FG 60SR/160	104	26,80
FG 60SR/200	104	32,50
FG 60PV/160	105	23,20
FG 60PV/200	105	27,30
FG 61/XT160	102	26,80
FG 61/XT200	102	32,00
FG 61PV/160	105	22,20
FG 61PV/200	105	24,30
FG 61/IS200	118	40,00
FG 62/XT160	103	28,90
FG 62SR/160	104	24,80
FG 62PV/160	105	22,00
FG 63/XT140	103	29,00
FG 63/XT160	103	31,00
FG 63/HL180	103	47,50
FG 63/H160	103	33,00
FG 63/H180	103	35,00
FG 63/H200	103	39,50
FG 63SR/160	104	27,00
FG 63SR/H200	104	34,00
FG 63PV/140	105	21,00
FG 63PV/160	105	23,00
FG 63PV/H180	105	29,00
FG 63PV/H200	105	30,00
FG 63/IS160	118	39,70
FG 63/HIS180	118	43,30
FG 63/HIS200	118	44,30
FG 64/XT160	103	36,00
FG 64/XT200	103	43,50
FG 64SR/220	104	30,00
FG 64SR/280	104	36,50
FG 64PV/160	105	27,00
FG 64PV/200	105	33,00
FG 65/XT160	103	28,00
FG 65PV/220	105	24,80
FG 65PV/250	105	26,80
FG 65PV/280	105	29,00
FG 65/SR250	209	33,50

CODICE	PAGINA	€/Pz
FG 66/TF220	108	105,00
FG 67/350	142	48,00
FG 67/450	142	61,00
FG 67/600	142	82,50
FG 67/750	142	107,00
FG 67/900	142	135,00
FG 67/350R	142	21,50
FG 67/450R	142	26,00
FG 67/600R	142	34,50
FG 67/750R	142	48,50
FG 67/900R	142	64,50
FG 68SR/160	104	31,00
FG 68/CS1	117	16,50
FG 68/CS1-R	117	6,30
FG 68/CS2	117	18,50
FG 68/CS2-R	117	6,30
FG 68/CS6	117	26,50
FG 68/CS6-R	117	8,30
FG 68/SP1	117	22,00
FG 68/S1	118	14,00
FG 68/SP	118	35,00
FG 68/SP2	118	15,00
FG 68IS/160	118	39,20
FG 68/TC230	119	83,00
FG 68/CC	119	175,00
FG 68/CR	119	212,00
FG 68/AT6	122	67,00
FG 68/AT16	122	67,00
FG 68/AG	122	67,00
FG 68/NI	122	75,00
FG 68/BNC	122	97,00
FG 68/RJ	122	75,00
FG 68/UN	122	88,00
FG 68/MAT4	122	43,50
FG 68/MAT16	122	43,50
FG 68/MAG	122	43,50
FG 68/MAN	122	43,50
FG 68/MAS	122	43,50
FG 68U/S439	122	298,00
FG 69/CJ180	108	24,00
FG 69/CJ250	108	26,50
FG 69/LN170	108	24,50
FG 69/LN230	108	28,50
FG 69/CC170	108	28,50
FG 69/CC280	108	38,00
FG 69/CC460	108	53,60
FG 69/CP170	109	34,50
FG 69/CP280	109	41,50
FG 69/CS200	109	32,50
FG 69/CW225	109	34,50
FG 69/PP215	109	37,80
FG 69/CH130	109	43,00
FG 69/PC	151	85,00
FG 70/CJ140	108	32,50
FG 70/CJ180	108	38,00
FG 70/CJ250	108	40,00
FG 70/CJ300	108	54,00
FG 70/LN165	108	39,00
FG 70/LN240	108	41,50
FG 70/CC175	108	45,00
FG 70/CC280	108	60,00
FG 70/CC460	108	115,00
FG 70/CP175	109	65,00
FG 70/CP280	109	70,00
FG 70/S110	145	335,00
FG 70/S65	145	560,00
FG 71/M3x0,5	143	12,50

CODICE	PAGINA	€/Pz
FG 71/M4x0,7	143	12,50
FG 71/M5x0,8	143	14,00
FG 71/M6x1	143	14,00
FG 71/M7x1	143	17,00
FG 71/M8x1,25	143	17,00
FG 71/M10x1,5	143	20,00
FG 71/M12x1,75	143	28,00
FG 71/M14x2	143	39,00
FG 71/M16x2	143	39,00
FG 71/M18x2,5	143	60,00
FG 71/M20x2,5	143	70,00
FG 71/M22x2,5	143	90,00
FG 71/M24x3	143	110,00
FG 72/M6x0,75	144	9,00
FG 72/M7x0,75	144	11,00
FG 72/M8x0,75	144	11,00
FG 72/M8x1	144	11,00
FG 72/M9x1	144	13,00
FG 72/M10x0,75	144	13,00
FG 72/M10x1	144	13,00
FG 72/M10x1,25	144	13,00
FG 72/M11x1	144	18,50
FG 72/M12x1	144	18,50
FG 72/M12x1,25	144	18,50
FG 72/M12x1,5	144	18,50
FG 72/M13x1,5	144	26,50
FG 72/M14x1	144	26,50
FG 72/M14x1,25	144	26,50
FG 72/M14x1,5	144	26,50
FG 72/M15x1,5	144	32,00
FG 72/M16x1	144	32,00
FG 72/M16x1,5	144	32,00
FG 72/M18x1,5	144	40,00
FG 72/M18x2	144	40,00
FG 72/M20x1,25	144	47,00
FG 72/M20x1,5	144	47,00
FG 72/M20x2	144	47,00
FG 72/M22x1,5	144	64,00
FG 72/M24x1	144	64,00
FG 72/M24x1,5	144	75,00
FG 72/M24x2	144	75,00
FG 72/GMM0	144	7,30
FG 72/GMM1	144	8,30
FG 72/GMM1,5	144	8,30
FG 72/GMM2	144	15,50
FG 72/GMM3	144	25,30
FG 72/GMM4	144	32,00
FG 72/GMM5	144	41,00
FG 72/GMC1	144	18,00
FG 72/GMC2	144	23,00
FG 72/GMC3	144	28,90
FG 72/GMC4	144	35,00
FG 72/GMC3	199	28,90
FG 72/GMC2	199	23,00
FG 72/M8X1	199	11,00
FG 72/M10x1	199	13,00
FG 73/M3x0,5	144	9,00
FG 73/M4x0,7	144	9,00
FG 73/M5x0,8	144	9,00
FG 73/M6x1	144	9,00
FG 73/M7x1	144	12,00
FG 73/M8x1,25	144	12,50
FG 73/M10x1,5	144	19,00
FG 73/M12x1,75	144	21,50
FG 73/M14x2	144	21,50
FG 73/M16x2	144	33,00
FG 73/M18x2,5	144	33,00

INDICE ANALITICO

CODICE	PAGINA	€/Pz
FG 73/M20x2,5	144	33,00
FG 73/M22x2,5	144	50,00
FG 73/M24x3	144	50,00
FG 74/M6x0,75	144	9,00
FG 74/M7x0,5	144	12,00
FG 74/M8x0,75	144	12,00
FG 74/M8x1	144	12,00
FG 74/M9x0,75	144	12,00
FG 74/M9x1	144	12,00
FG 74/M9x1,25	144	12,00
FG 74/M10x0,5	144	18,50
FG 74/M10x0,75	144	18,50
FG 74/M10x1	144	18,50
FG 74/M10x1,25	144	18,50
FG 74/M11x0,5	144	18,50
FG 74/M11x0,75	144	18,50
FG 74/M11x1	144	18,50
FG 74/M12x0,75	144	31,00
FG 74/M12x1	144	31,00
FG 74/M12x1,25	144	31,00
FG 74/M12x1,5	145	31,00
FG 74/M14x1	145	31,00
FG 74/M14x1,25	145	31,00
FG 74/M14x1,5	145	31,00
FG 74/M15x1	145	31,00
FG 74/M16x1	145	46,00
FG 74/M16x1,5	145	46,00
FG 74/M18x1,5	145	46,00
FG 74/M20x1,25	145	46,00
FG 74/M20x1,5	145	46,00
FG 74/M20x2	145	46,00
FG 74/M21x1,5	145	46,00
FG 74/M22x1,5	145	73,00
FG 74/M24x1	145	73,00
FG 74/M24x1,5	145	73,00
FG 74/M24x2	145	73,00
FG 74/GF16x5	145	6,60
FG 74/GF20x5	145	6,60
FG 74/GF20x7	145	6,60
FG 74/GF25x9	145	7,50
FG 74/GF30x11	145	10,00
FG 74/GF38x14	145	18,50
FG 74/GF45x18	145	26,00
FG 74/GF55x22	145	26,00
FG 74/GF65x25	145	34,00
FG 74/PM3x0,5	145	18,50
FG 74/PM4x0,7	145	18,50
FG 74/PM5x0,8	145	18,50
FG 74/PM6x1	145	18,50
FG 74/PM8x1,25	145	20,50
FG 74/PM10x1,5	145	21,00
FG 74PM/S7	145	118,00
FG 75/HSS0,5	148	1,90
FG 75/HSS1	148	1,50
FG 75/HSS1,25	148	1,50
FG 75/HSS1,5	148	1,30
FG 75/HSS1,75	148	1,30
FG 75/HSS2	148	1,20
FG 75/HSS2,25	148	1,40
FG 75/HSS2,5	148	1,30
FG 75/HSS2,75	148	1,90
FG 75/HSS3	148	1,50
FG 75/HSS3,1	148	1,70
FG 75/HSS3,2	148	1,90
FG 75/HSS3,25	148	1,70
FG 75/HSS3,5	148	1,60
FG 75/HSS3,75	148	2,00

CODICE	PAGINA	€/Pz
FG 75/HSS4	148	1,80
FG 75/HSS4,1	148	2,10
FG 75/HSS4,2	148	2,10
FG 75/HSS4,25	148	2,20
FG 75/HSS4,5	148	2,00
FG 75/HSS4,75	148	2,40
FG 75/HSS5	148	2,10
FG 75/HSS5,1	148	2,80
FG 75/HSS5,25	148	3,10
FG 75/HSS5,5	148	2,80
FG 75/HSS5,75	148	3,30
FG 75/HSS6	148	2,90
FG 75/HSS6,25	148	4,00
FG 75/HSS6,5	148	3,70
FG 75/HSS6,75	148	4,40
FG 75/HSS7	148	4,80
FG 75/HSS7,5	148	4,40
FG 75/HSS8	148	5,30
FG 75/HSS8,5	148	6,40
FG 75/HSS9	148	6,70
FG 75/HSS9,5	148	7,00
FG 75/HSS10	148	7,80
FG 75/HSS10,5	148	9,30
FG 75/HSS11	148	11,40
FG 75/HSS11,5	148	11,90
FG 75/HSS12	148	12,90
FG 75/HSS12,5	148	14,00
FG 75/HSS13	148	15,00
FG 75/HSS14	148	22,70
FG 75/HSS15	148	27,90
FG 75/HSS16	148	32,00
FG 75/HSS17	148	38,20
FG 75/HSS18	148	45,40
FG 75/HSS19	148	48,50
FG 75/HSS20	148	55,70
FG 75HSS/S25	149	140,00
FG 75/S25	149	78,00
FG 75/S170	149	258,00
FG 75/TIN0,5	149	1,80
FG 75/TIN1	149	1,80
FG 75/TIN1,5	149	1,50
FG 75/TIN2	149	1,70
FG 75/TIN2,5	149	1,80
FG 75/TIN3	149	2,20
FG 75/TIN3,5	149	2,40
FG 75/TIN4	149	2,50
FG 75/TIN4,5	149	2,90
FG 75/TIN5	149	3,30
FG 75/TIN5,5	149	4,00
FG 75/TIN6	149	4,40
FG 75/TIN6,5	149	4,80
FG 75/TIN7	149	5,30
FG 75/TIN7,5	149	6,50
FG 75/TIN8	149	7,60
FG 75/TIN8,5	149	9,30
FG 75/TIN9	149	10,10
FG 75/TIN9,5	149	11,40
FG 75/TIN10	149	11,70
FG 75/TIN10,5	149	13,00
FG 75/TIN11	149	14,00
FG 75/TIN11,5	149	15,30
FG 75/TIN12	149	16,00
FG 75/TIN12,5	149	17,60
FG 75/TIN13	149	19,60
FG 75TIN/S13	150	59,00
FG 75TIN/S19	150	95,00
FG 75TIN/S25	150	198,00

CODICE	PAGINA	€/Pz
FG 75/CO0,5	150	4,20
FG 75/CO1	150	2,80
FG 75/CO1,5	150	2,80
FG 75/CO2	150	2,80
FG 75/CO2,5	150	2,90
FG 75/CO3	150	2,90
FG 75/CO3,5	150	3,80
FG 75/CO4	150	4,40
FG 75/CO4,5	150	5,10
FG 75/CO5	150	5,20
FG 75/CO5,5	150	7,00
FG 75/CO6	150	7,50
FG 75/CO6,5	150	8,80
FG 75/CO7	150	10,70
FG 75/CO7,5	150	12,70
FG 75/CO8	150	13,70
FG 75/CO8,5	150	14,50
FG 75/CO9	150	18,10
FG 75/CO9,5	150	19,50
FG 75/CO10	150	22,20
FG 75/CO10,5	150	25,80
FG 75/CO11	150	28,90
FG 75/CO11,5	150	30,90
FG 75/CO12	150	34,60
FG 75/CO12,5	150	37,10
FG 75/CO13	150	41,20
FG 75CO/S19	150	113,00
FG 75CO/S25	150	236,00
FG 75/HSS3,5	199	1,60
FG 76/HSS14	149	22,70
FG 76/HSS15	149	26,80
FG 76/HSS16	149	29,90
FG 76/HSS17	149	35,10
FG 76/HSS18	149	41,20
FG 76/HSS19	149	43,30
FG 76/HSS20	149	49,50
FG 76/R1	150	15,50
FG 76/R3	150	41,00
FG 76/R2	151	25,00
FG 76/R4	151	38,00
FG 77/TT	141	9,90
FG 77/PVC1	151	35,00
FG 77/PVC5	151	56,00
FG 77/PVC4	151	70,00
FG 77/PVC4-R	151	30,00
FG 78/HSS14	147	8,70
FG 78/HSS16	147	8,70
FG 78/HSS17	147	8,70
FG 78/HSS19	147	8,70
FG 78/HSS20	147	8,70
FG 78/HSS21	147	8,90
FG 78/HSS22	147	8,90
FG 78/HSS24	147	8,90
FG 78/HSS25	147	9,00
FG 78/HSS27	147	9,10
FG 78/HSS28	147	9,10
FG 78/HSS29	147	9,10
FG 78/HSS30	147	9,30
FG 78/HSS32	147	9,90
FG 78/HSS33	147	10,20
FG 78/HSS35	147	10,90
FG 78/HSS37	147	11,40
FG 78/HSS38	147	11,40
FG 78/HSS40	147	11,60
FG 78/HSS41	147	11,90
FG 78/HSS43	147	11,90
FG 78/HSS44	147	12,10

CODICE	PAGINA	€/Pz
FG 78/HSS46	147	12,10
FG 78/HSS48	147	12,10
FG 78/HSS50	147	12,80
FG 78/HSS51	147	12,80
FG 78/HSS52	147	12,80
FG 78/HSS54	147	14,00
FG 78/HSS57	147	14,40
FG 78/HSS59	147	14,40
FG 78/HSS60	147	15,00
FG 78/HSS64	147	15,10
FG 78/HSS65	147	15,50
FG 78/HSS67	147	15,80
FG 78/HSS68	147	15,80
FG 78/HSS70	147	16,70
FG 78/HSS73	147	17,00
FG 78/HSS76	147	17,90
FG 78/HSS79	147	19,00
FG 78/HSS83	147	21,70
FG 78/HSS86	147	22,20
FG 78/HSS89	147	22,70
FG 78/HSS92	147	23,70
FG 78/HSS95	147	24,80
FG 78/HSS98	147	25,80
FG 78/HSS102	147	27,90
FG 78/HSS105	147	29,40
FG 78/HSS108	147	30,40
FG 78/HSS111	147	32,00
FG 78/HSS114	147	34,00
FG 78/HSS121	147	36,10
FG 78/HSS127	147	37,10
FG 78/HSS133	147	40,20
FG 78/HSS140	147	43,30
FG 78/HSS146	147	45,40
FG 78/HSS152	147	49,50
FG 78/AL14	147	19,00
FG 78/AL12	147	37,00
FG 78/PC1	147	8,30
FG 78/SP1	147	2,60
FG 78/PR1	147	21,70
FG 78HSS/S12	147	220,00
FG 78HSS/S17	148	335,00
FG 79/SP	303	4,00
FG 79/SP2	303	9,50
FG 79/SP4	303	5,30
FG 79/SP3	303	5,50
FG 79/SR	317	16,50
FG 79/SR1R	317	6,00
FG 79/SB	317	23,00
FG 80/BL140	124	32,00
FG 80/BLP140	124	32,00
FG 80/BP125	124	32,00
FG 80/8AR	143	15,00
FG 80/8AM	143	15,00
FG 80/8AP	143	17,00
FG 80/8AT	143	15,00
FG 80/8AQ	143	17,00
FG 80/S5B	143	78,00
FG 80HSS/1	146	22,00
FG 80HSS/2	146	40,00
FG 80HSS/3	146	75,00
FG 80HSS/S3	146	145,00
FG 80MD/ET3	146	13,00
FG 80MD/ET6	146	39,00
FG 80MD/ET12.7	146	68,00
FG 80MD/ER3	146	13,00
FG 80MD/ER6	146	39,00
FG 80MD/ER12.7	146	68,00

CODICE	PAGINA	€/Pz
FG 80MD/SV3	146	13,00
FG 80MD/SV6	146	39,00
FG 80MD/SV12.7	146	68,00
FG 80MD/EC3	146	13,00
FG 80MD/EC6	146	39,00
FG 80MD/EC12.7	146	68,00
FG 80MD/CS3	146	13,00
FG 80MD/CS6	146	39,00
FG 80MD/CS12.7	146	68,00
FG 80MD/AR3	146	13,00
FG 80MD/AR6	146	39,00
FG 80MD/AR12.7	146	68,00
FG 81/BT125	124	32,00
FG 81/BML140	124	32,00
FG 81/BMC140	124	32,00
FG 81/BMZ140	124	32,00
FG 81/BMR140	124	32,00
FG 81/BMP140	124	32,00
FG 81/8AR	143	11,50
FG 81/8AM	143	15,00
FG 81/8AP	143	14,50
FG 81/8AT	143	14,50
FG 81/8AQ	143	15,50
FG 81/S5B	143	75,00
FG 81HSS/1	146	45,00
FG 81HSS/2	146	62,00
FG 81HSS/3	146	135,00
FG 81HSS/S3	146	245,00
FG 81/S1	165	18,50
FG 81/S2	165	24,00
FG 81/S3	165	28,50
FG 81/S4	165	33,00
FG 81/S5	165	39,50
FG 81/C1	165	21,00
FG 81/C2	165	30,00
FG 81/C3	165	35,00
FG 81/C4	165	42,00
FG 81/C5	165	50,00
FG 81/PT1	165	24,00
FG 81/PT2	166	9,50
FG 81/MS	166	0,70
FG 82/TDS120	125	32,00
FG 82/DSA120	125	32,00
FG 82/DRS120	125	32,00
FG 82/DRS130	125	36,00
FG 82/DRA120	125	32,00
FG 82/DRA130	125	35,00
FG 82/RAS120	125	32,00
FG 82/RAS130	125	36,00
FG 82/RT	143	11,50
FG 82/RST	143	11,50
FG 83/TF120	125	32,00
FG 83/TD130	125	36,10
FG 83/AR	143	5,00
FG 83/AT	143	5,00
FG 83/AQ	143	5,00
FG 83/AM	143	5,00
FG 83/AP	143	5,00
FG 83/AW	143	5,00
FG 83/S6	143	30,00
FG 84/F1	122	4,60
FG 84/F2	122	4,60
FG 84/F3	122	4,60
FG 84/F4	122	4,60
FG 84/F5	122	4,60
FG 84/F7	122	4,60
FG 84/PH00	122	4,60

CODICE	PAGINA	€/Pz
FG 84/PH0	122	4,60
FG 84/PH1	122	4,60
FG 84/H1.5	123	5,40
FG 84/H2	123	5,40
FG 84/H2.5	123	5,40
FG 84/H3	123	5,40
FG 84/TX3	123	5,30
FG 84/TX4	123	5,30
FG 84/TX5	123	5,30
FG 84/TX6	123	5,30
FG 84/TX7	123	5,30
FG 84/TX8	123	5,30
FG 84/TX9	123	5,30
FG 84/TX10	123	5,30
FG 84/TX15	123	5,30
FG 84/TX20	123	5,30
FG 84F/S6	123	29,90
FG 84F/S6B	123	29,90
FG 84F/S6C	123	29,90
FG 84PH/S6	123	29,90
FG 84PH/S6B	123	29,90
FG 84TX/S6	123	33,00
FG 84/TOR130	125	36,00
FG 84/ORS130	125	36,00
FG 85/25F1	95	1,30
FG 85/25F2	95	1,30
FG 85/25F3	95	1,30
FG 85/25F4	95	1,30
FG 85/25F5	95	1,30
FG 85/25F6	95	2,10
FG 85/25F7	95	2,10
FG 85/50F1	95	3,20
FG 85/50F2	95	3,20
FG 85/50F3	95	3,20
FG 85/50F4	95	3,20
FG 85/50F5	95	3,20
FG 85/50F6	95	3,70
FG 85/50F7	95	3,70
FG 85/25PH0	95	1,70
FG 85/25PH1	95	1,80
FG 85/25PH2	95	1,80
FG 85/25PH3	95	1,80
FG 85/50PH1	95	3,70
FG 85/70PH1	95	5,30
FG 85/50PH2	95	3,70
FG 85/70PH2	95	5,30
FG 85/50PH3	95	3,70
FG 85/70PH3	95	5,30
FG 85/25Z1	95	1,20
FG 85/25Z2	95	1,20
FG 85/25Z3	95	1,20
FG 85/25Z4	95	1,20
FG 85/50Z1	95	3,70
FG 85/50Z2	95	3,70
FG 85/50Z3	95	3,70
FG 85/25TT10	95	2,30
FG 85/25TT15	95	2,30
FG 85/25TT20	95	2,30
FG 85/25TT25	95	2,30
FG 85/25TT27	95	2,30
FG 85/25TT30	95	2,30
FG 85/25TT40	95	2,30
FG 85/25M4	95	1,20
FG 85/25M5	95	1,20
FG 85/25M6	95	1,20
FG 85/25M10	95	1,20
FG 85/25H1.5	96	1,40

CODICE	PAGINA	€/Pz
FG 85/25H2	96	1,40
FG 85/25H2.5	96	1,40
FG 85/25H3	96	1,40
FG 85/25H4	96	1,40
FG 85/25H5	96	1,40
FG 85/25H6	96	1,40
FG 85/25H7	96	1,80
FG 85/25H8	96	1,80
FG 85/25H10	96	2,30
FG 85/50H3	96	3,50
FG 85/50H4	96	3,50
FG 85/50H5	96	3,50
FG 85/50H6	96	3,50
FG 85/50H7	96	4,20
FG 85/50H8	96	4,20
FG 85/50H10	96	4,20
FG 85/25T9	96	1,80
FG 85/25T10	96	1,80
FG 85/25T15	96	1,80
FG 85/25T20	96	1,80
FG 85/25T25	96	1,80
FG 85/25T27	96	1,80
FG 85/25T30	96	1,80
FG 85/25T40	96	1,80
FG 85/25T45	96	2,00
FG 85/25T50	96	2,30
FG 85/50T9	96	4,50
FG 85/50T10	96	4,50
FG 85/50T15	96	4,50
FG 85/50T20	96	4,50
FG 85/50T25	96	4,50
FG 85/50T27	96	4,50
FG 85/50T30	96	4,50
FG 85/50T40	96	4,50
FG 85/50T45	96	5,50
FG 85/50T50	96	5,50
FG 85/S31	96	68,30
FG 85TX/S11	96	33,60
FG 85/S11	97	29,40
FG 85/S100	97	98,00
FG 85/100F3	98	5,30
FG 85/100F4	98	5,30
FG 85/100F5.5	98	5,30
FG 85/100PZ1	98	5,70
FG 85/100PZ2	98	5,70
FG 85/100PZ3	98	5,70
FG 85/100PH1	98	5,70
FG 85/100PH2	98	5,70
FG 85/100PH3	98	5,70
FG 85/100H4	98	5,50
FG 85/100H5	98	5,50
FG 85/100H6	98	5,50
FG 85/100T15	98	5,70
FG 85/100T20	98	5,70
FG 85/100T25	98	5,70
FG 85/S15L	98	96,60
FG 85/TW1	123	12,70
FG 85/TW2	123	12,70
FG 85/TW3	123	12,70
FG 85/TW4	123	12,70
FG 85/TW5	123	12,70
FG 86/30H4	99	1,70
FG 86/30H5	99	1,70
FG 86/30H6	99	1,70
FG 86/30H7	99	1,70
FG 86/30H8	99	1,70
FG 86/30H10	99	1,70

CODICE	PAGINA	€/Pz
FG 86/30H12	99	2,60
FG 86/30H14	99	3,60
FG 86/75H4	99	3,10
FG 86/75H5	99	3,10
FG 86/75H6	99	3,10
FG 86/75H7	99	3,10
FG 86/75H8	99	3,10
FG 86/75H10	99	3,10
FG 86/75H12	99	4,20
FG 86/75H14	99	5,70
FG 86/30T20	99	1,70
FG 86/30T25	99	1,70
FG 86/30T27	99	1,70
FG 86/30T30	99	1,70
FG 86/30T40	99	1,70
FG 86/30T45	99	1,70
FG 86/30T50	99	1,70
FG 86/30T55	99	1,70
FG 86/75T20	100	2,80
FG 86/75T25	100	2,80
FG 86/75T27	100	2,80
FG 86/75T30	100	2,80
FG 86/75T40	100	2,80
FG 86/75T45	100	2,80
FG 86/75T50	100	2,80
FG 86/75T55	100	2,80
FG 86/30TT20	100	1,80
FG 86/30TT25	100	1,80
FG 86/30TT27	100	1,80
FG 86/30TT30	100	1,80
FG 86/30TT40	100	1,80
FG 86/30TT45	100	1,80
FG 86/30TT50	100	1,80
FG 86/30TT55	100	1,80
FG 86/75TT20	100	3,10
FG 86/75TT25	100	3,10
FG 86/75TT27	100	3,10
FG 86/75TT30	100	3,10
FG 86/75TT40	100	3,10
FG 86/75TT45	100	3,10
FG 86/75TT50	100	3,10
FG 86/75TT55	100	3,10
FG 86/30M5	100	2,10
FG 86/30M6	100	2,10
FG 86/30M8	100	2,10
FG 86/30M10	100	2,10
FG 86/30M12	100	3,00
FG 86/30M14	100	3,60
FG 86/75M5	100	3,70
FG 86/75M6	100	3,70
FG 86/75M8	100	3,70
FG 86/75M10	100	3,80
FG 86/75M12	100	4,10
FG 86/AD2	100	5,80
FG 86/S30B	100	89,30
FG 87/25F1	101	4,20
FG 87/25F2	101	4,20
FG 87/25F3	101	4,90
FG 87/25F4	101	5,40
FG 87/PH1	101	3,20
FG 87/PH2	101	3,20
FG 87/PH3	101	3,20
FG 87/PH4	101	3,20
FG 87/PZ1	101	3,70
FG 87/PZ2	101	3,70
FG 87/PZ3	101	3,70
FG 87/H4	101	3,20

INDICE ANALITICO

CODICE	PAGINA	€/Pz
FG 87/H5	101	3,20
FG 87/H6	101	3,20
FG 87/H8	101	3,20
FG 87/H10	101	4,20
FG 87/TX20	101	4,20
FG 87/TX25	101	4,20
FG 87/TX27	101	4,20
FG 87/TX30	101	4,20
FG 87/TX40	101	4,20
FG 87/TX45	101	4,20
FG 87/TX50	101	6,30
FG 87/TX55	101	6,30
FG 87/AD	101	6,90
FG 88/P14	98	25,20
FG 88/60PI1	99	10,50
FG 88/60PI2	99	9,50
FG 88/60PI3	99	13,20
FG 88/100SDS	99	23,70
FG 88/75PB1	99	17,40
FG 88/75PB2	99	20,50
FG 88/75PB3	99	23,70
FG 89/38PI1	99	20,50
FG 89/50PI2	99	23,70
FG 89/50PI3	99	24,20
FG 89/55PI4	99	27,30
FG 89/55PI5	99	29,40
FG 92/PF	304	27,50
FG 92/PM1	304	10,50
FG 92/PM4	304	27,50
FG 92/PM	304	19,00
FG 92/GR	304	27,00
FG 93/M50	304	30,00
FG 93/M95	304	30,00
FG 94/300	165	28,00
FG 94/600	165	38,00
FG 94/800	165	54,00
FG 94/1000	165	70,00
FG 94/MI	371	52,00
FG 94/MS	371	34,00
FG 94/R	371	20,00
FG 94/T	371	17,00
FG 95/CF	166	16,00
FG 95/CA	166	52,00
FG 95/CA2	166	125,00
FG 95/CP1	166	96,00
FG 95/DG	166	95,00
FG 95/GO1	167	72,50
FG 95/GO2	167	89,00
FG 95/GO3	167	105,00
FG 95/M1	167	58,00
FG 95/M2	167	62,00
FG 95/M3	167	72,00
FG 95/M4	167	89,00
FG 95/CO	167	110,00
FG 95/BA	167	75,00
FG 95/SP100	305	65,00
FG 96/DG	121	185,00
FG 96/SS30	305	48,00
FG 96/SS60	305	60,00
FG 96/TIP1	305	7,00
FG 96/TIP2	305	7,00
FG 96/SS36	305	65,00
FG 97/DG	121	135,00
FG 97/T1	167	250,00
FG 97/T2	167	450,00
FG 97/LT	217	250,00
FG 98/DG	121	340,00

CODICE	PAGINA	€/Pz
FG 98/A15	217	280,00
FG 98/A6	217	120,00
FG 98/A1	217	65,00
FG 98/GAS	305	125,00
FG 98/TIP1	305	16,50
FG 98/TIP2	305	16,50
FG 98/TIP3	305	16,50
FG 98/TIP4	305	16,50
FG 98/STA	305	12,00
FG 98/ST8	305	16,50
FG 98/PC8	305	16,50
FG 98/SS	306	12,00
FG 98/AS	306	3,00
FG 98/LT	306	170,00
FG 99/DG	121	250,00
FG 99	217	550,00
FG 99/B	217	670,00
FG 99/C	217	1.900,00
FG 100V/5T	335	1.000,00
FG 100B/5T	335	1.000,00
FG 100R/5T	335	1.000,00
FG 100D/5T	335	1.000,00
FG 100W/5T	335	1.000,00
FG 100V/6T	335	1.050,00
FG 100B/6T	335	1.050,00
FG 100R/6T	335	1.050,00
FG 100D/6T	335	1.050,00
FG 100W/6T	335	1.050,00
FG 100V/7T	335	1.100,00
FG 100B/7T	335	1.100,00
FG 100R/7T	335	1.100,00
FG 100D/7T	335	1.100,00
FG 100W/7T	335	1.100,00
FG 100VD/7T	337	1.350,00
FG 100VW/7T	337	1.350,00
FG 100BW/7T	337	1.350,00
FG 100BD/7T	337	1.350,00
FG 100RD/7T	337	1.350,00
FG 100RY/7T	337	1.350,00
FG 100CW/7T	337	1.350,00
FG 100MA/7T	337	1.350,00
FG 100RW/7T	337	1.350,00
FG 100RB/7T	337	1.350,00
FG 100DP/7T	337	1.350,00
FG 100DW/7T	337	1.350,00
FG 100BY/7T	337	1.350,00
FG 100GW/7T	337	1.350,00
FG 100/03G	346	160,00
FG TER 100/03G	346	24,00
FG 100/03H	346	295,00
FG TER 100/03H	346	48,00
FG 100/03L	346	158,00
FG TER 100/03L	346	24,00
FG 100/03E	346	95,00
FG TER 100/03E	346	24,00
FG 100/03F	346	105,00
FG TER 100/03F	346	24,00
FG 100/03TX	346	60,00
FG TER 100/03TX	346	15,00
FG 100/07C	346	109,60
FG TER 100/07C	346	24,00
FG 100/07D	346	155,00
FG TER 100/07D	346	24,00
FG 100/08C	346	245,00
FG TER 100/08C	346	24,00
FG 100/10C	347	377,50
FG TER 100/10C	347	70,00

CODICE	PAGINA	€/Pz
FG 100/10D	347	549,00
FG TER 100/10D	347	70,00
FG 100/10H	347	307,50
FG TER 100/10H	347	70,00
FG 100/10TX	347	418,50
FG TER 100/10TX	347	70,00
FG 100/13C	347	202,90
FG TER 100/13C	347	24,00
FG 100/12B	347	178,60
FG TER 100/12B	347	24,00
FG 100/17	347	142,00
FG TER 100/17	347	24,00
FG 100/03IN	347	122,50
FG TER 100/03IN	347	24,00
FG 100/17E	348	285,00
FG TER 100/17E	348	24,00
FG 100/17IN	348	167,20
FG TER 100/17IN	348	24,00
FG 100/18	348	295,00
FG TER 100/18	348	24,00
FG 100/19	348	230,00
FG TER 100/19	348	24,00
FG 100/19IN	349	230,00
FG TER 100/19IN	349	24,00
FG 100/18B	349	260,00
FG TER 100/18B	349	24,00
FG 100/19B	349	210,00
FG TER 100/19B	349	24,00
FG 100/21B	349	245,00
FG TER 100/21B	349	24,00
FG 100/21C	350	245,00
FG TER 100/21C	350	24,00
FG 100/21D	350	165,00
FG TER 100/21D	350	24,00
FG 100/21M	350	165,00
FG TER 100/21M	350	24,00
FG 100/21E	350	420,00
FG TER 100/21E	350	35,00
FG 100/21IN	350	260,00
FG TER 100/21IN	350	24,00
FG 100/21G	351	330,00
FG TER 100/21G	351	24,00
FG 100/21H	351	430,00
FG TER 100/21H	351	35,00
FG 100/21TX	351	260,00
FG TER 100/21TX	351	24,00
FG 100/23B	351	360,00
FG TER 100/23B	351	35,00
FG 100/23C	351	220,00
FG TER 100/23C	351	24,00
FG 100/25	351	420,00
FG TER 100/25	351	35,00
FG 100/25B	352	420,00
FG TER 100/25B	352	35,00
FG 100/39XT	352	104,00
FG TER 100/39XT	352	24,00
FG 100/39C	352	95,00
FG TER 100/39C	352	24,00
FG 100/41C	352	110,00
FG TER 100/41C	352	24,00
FG 100/42C	352	115,00
FG TER 100/42C	352	24,00
FG 100/48D	352	110,00
FG TER 100/48D	352	14,00
FG 100/48G	352	130,00
FG TER 100/48G	352	24,00
FG 100/45D	352	65,00

CODICE	PAGINA	€/Pz
FG TER 100/45D	352	24,00
FG 100/45E	352	80,00
FG TER 100/45E	352	24,00
FG 100/45F	353	68,00
FG TER 100/45F	353	23,00
FG 100/45G	353	68,00
FG TER 100/45G	353	24,00
FG 100/45I	353	82,00
FG TER 100/45I	353	24,00
FG 100/45H	353	80,00
FG TER 100/45H	353	48,00
FG 100/45L	353	84,00
FG TER 100/45L	353	24,00
FG 100/45M	353	73,50
FG TER 100/45M	353	23,00
FG 100/45Q	353	132,50
FG TER 100/45Q	353	24,00
FG 100/45T	353	85,00
FG TER 100/45T	353	24,00
FG 100/50E	353	200,00
FG TER 100/50E	353	48,00
FG 100/50F	354	90,00
FG TER 100/50F	354	24,00
FG 100/50G	354	90,00
FG TER 100/50G	354	24,00
FG 100/53	354	310,00
FG TER 100/53	354	35,00
FG 100/53B	354	570,00
FG TER 100/53B	354	35,00
FG 100/51H	354	145,00
FG TER 100/51H	354	24,00
FG 100/52A	354	184,00
FG TER 100/52A	354	35,00
FG 100/52B	354	166,00
FG TER 100/52B	354	24,00
FG 100/52C	354	151,00
FG TER 100/52C	354	24,00
FG 100/52D	354	103,00
FG TER 100/52D	354	24,00
FG 100/52E	355	89,00
FG TER 100/52E	355	24,00
FG 100/52F	355	111,00
FG TER 100/52F	355	24,00
FG 100/52G	355	122,00
FG TER 100/52G	355	24,00
FG 100/52H	355	232,00
FG TER 100/52H	355	70,00
FG 100/68	355	122,00
FG TER 100/68	355	24,00
FG 100/55B	355	120,00
FG TER 100/55B	355	24,00
FG 100/56C	355	135,00
FG TER 100/56C	355	24,00
FG 100/54	355	170,00
FG TER 100/54	355	24,00
FG 100/65B	355	92,50
FG TER 100/65B	355	24,00
FG 100/65C	356	131,80
FG TER 100/65C	356	24,00
FG 100/62B	356	98,00
FG TER 100/62B	356	24,00
FG 100/76C	356	274,00
FG TER 100/76C	356	24,00
FG 100/81F	356	200,00
FG TER 100/81F	356	24,00
FG 100/82B	356	170,00
FG TER 100/82B	356	24,00

CODICE	PAGINA	€/Pz
FG 100/VA1	356	24,00
FG 100/VA2	356	14,00
FG 100/VA3	356	24,00
FG 100/VA4	356	21,00
FG 100/AS161	357	1.357,60
FG 100/AS226	357	1.738,50
FG 100/AS173	358	1.953,00
FG 100/AS230	358	2.311,50
FG 100/AS248	359	2.747,50
FG 100/AS360	359	2.740,30
FG 100/AS304	360	2.766,00
FG 100/AS56	360	1.931,10
FG 100/AS171	361	1.801,00
FG 100/AS284	361	2.950,00
FG 100/PR	370	62,00
FG 100/PL	371	50,00
FG 101V/5G	340	680,00
FG 101V/6G	340	710,00
FG 101V/7G	340	750,00
FG 101V/3G	341	500,00
FG 102D/5G	338	960,00
FG 102B/5G	338	960,00
FG 102R/5G	338	960,00
FG 102V/5G	338	960,00
FG 102D/6G	338	1.030,00
FG 102B/6G	338	1.030,00
FG 102R/6G	338	1.030,00
FG 102V/6G	338	1.030,00
FG 102D/7G	338	1.100,00
FG 102B/7G	338	1.100,00
FG 102R/7G	338	1.100,00
FG 102V/7G	338	1.100,00
FG 102D/8G	339	1.150,00
FG 102B/8G	339	1.150,00
FG 102R/8G	339	1.150,00
FG 102V/8G	339	1.150,00
FG 102/03E	362	80,00
FG TER 102/03E	362	15,00
FG 102/03F	362	96,00
FG TER 102/03F	362	20,00
FG 102/03G	362	140,00
FG TER 102/03G	362	15,00
FG 102/03H	362	250,00
FG TER 102/03H	362	20,00
FG 102/03L	362	145,00
FG TER 102/03L	362	15,00
FG 102/07C	362	96,00
FG TER 102/07C	362	15,00
FG 102/07D	362	135,00
FG TER 102/07D	362	15,00
FG 102/08C	362	245,00
FG TER 102/08C	362	15,00
FG 102/10C	362	330,00
FG TER 102/10C	362	24,00
FG 102/17	363	132,00
FG TER 102/17	363	15,00
FG 102/17E	363	265,00
FG TER 102/17E	363	15,00
FG 102/19	363	200,00
FG TER 102/19	363	15,00
FG 102/21B	363	240,00
FG TER 102/21B	363	15,00
FG 102/21C	363	240,00
FG TER 102/21C	363	15,00
FG 102/21D	363	165,00
FG TER 102/21D	363	15,00
FG 102/21E	364	165,00

CODICE	PAGINA	€/Pz
FG TER 102/21E	364	15,00
FG 102/21TX	364	235,00
FG TER 102/21TX	364	15,00
FG 102/21H	364	200,00
FG TER 102/21H	364	15,00
FG 102/21R	364	220,00
FG TER 102/21R	364	15,00
FG 102/25	364	395,00
FG TER 102/25	364	20,00
FG 102/25B	364	395,00
FG TER 102/25B	364	20,00
FG 102/23C	365	145,50
FG TER 102/23C	365	15,00
FG 102/13C	365	185,00
FG TER 102/13C	365	20,00
FG 102/51H	365	130,00
FG TER 102/51H	365	15,00
FG 102/39XT	365	96,00
FG TER 102/39XT	365	15,00
FG 102/39C	365	85,00
FG TER 102/39C	365	15,00
FG 102/39D	365	74,00
FG TER 102/39D	365	15,00
FG 102/41C	365	96,00
FG TER 102/41C	365	15,00
FG 102/42C	365	106,00
FG TER 102/42C	365	15,00
FG 102/45D	366	45,00
FG TER 102/45D	366	15,00
FG 102/45E	366	55,00
FG TER 102/45E	366	15,00
FG 102/45F	366	52,00
FG TER 102/45F	366	15,00
FG 102/45G	366	52,00
FG TER 102/45G	366	15,00
FG 102/45U	366	96,00
FG TER 102/45U	366	20,00
FG 102/45I	366	64,00
FG TER 102/45I	366	15,00
FG 102/45L	366	65,00
FG TER 102/45L	366	15,00
FG 102/45T	366	75,00
FG TER 102/45T	366	15,00
FG 102/48G	367	120,00
FG TER 102/48G	367	15,00
FG 102/48D	367	95,00
FG TER 102/48D	367	15,00
FG 102/50F	367	76,00
FG TER 102/50F	367	15,00
FG 102/50G	367	76,00
FG TER 102/50G	367	15,00
FG 102/56C	367	125,00
FG TER 102/56C	367	15,00
FG 102/60D	367	51,00
FG TER 102/60D	367	15,00
FG 102/62B	367	90,00
FG TER 102/62B	367	15,00
FG 102/65B	367	65,00
FG TER 102/65B	367	15,00
FG 102/VA1	367	15,00
FG 102/AS190	368	1.450,50
FG 102/AS356	368	2.552,30
FG 102/AS149	369	1.342,00
FG 102/AS158	369	1.530,00
FG 102/AS193	370	1.490,00
FG 102/PL	370	58,00
FG 102/PC	370	80,00

CODICE	PAGINA	€/Pz
FG 102/TG	370	50,00
FG 102/PA	371	30,00
FG 104D/6G	339	1.250,00
FG 104B/6G	339	1.250,00
FG 104R/6G	339	1.250,00
FG 104V/6G	339	1.250,00
FG 104D/7G	339	1.350,00
FG 104B/7G	339	1.350,00
FG 104R/7G	339	1.350,00
FG 104V/7G	339	1.350,00
FG 104/TG	371	65,00
FG 105D/5G	342	1.300,00
FG 105B/5G	342	1.300,00
FG 105R/5G	342	1.300,00
FG 105V/5G	342	1.300,00
FG 105D/6G	342	1.400,00
FG 105B/6G	342	1.400,00
FG 105R/6G	342	1.400,00
FG 105V/6G	342	1.400,00
FG 105D/7G	342	1.450,00
FG 105B/7G	342	1.450,00
FG 105R/7G	342	1.450,00
FG 105V/7G	342	1.450,00
FG 106/A	379	250,00
FG 106/B	379	300,00
FG 106/C	379	390,00
FG 107/A	379	165,00
FG BEST 108	70	270,00
FG 108/B	341	180,00
FG 109/L3	324	280,00
FG 109D/6G	343	1.600,00
FG 109B/6G	343	1.600,00
FG 109R/6G	343	1.600,00
FG 109D/7G	343	1.650,00
FG 109B/7G	343	1.650,00
FG 109R/7G	343	1.650,00
FG 110	341	380,00
FG 111/A	320	60,00
FG 111/B	320	72,00
FG 111/C	320	88,00
FG 111/AS55	321	642,50
FG 111/AS104	321	863,50
FG 113/A	320	175,00
FG 113/B	320	210,00
FG 113/C	320	250,00
FG 113/D	320	300,00
FG 113/A-VA	320	32,00
FG 113/B-VA	320	42,00
FG 113/D-VA	320	50,00
FG 114/L2	324	65,00
FG 114/L3	324	110,00
FG 115/A	328	250,00
FG 115/B	328	290,00
FG 116/A	328	390,00
FG 116/CO2V	406	4.305,00
FG 116/CO1V	406	4.770,00
FG 116/CO6V	406	4.355,00
FG 116/CO10V	406	3.535,00
FG 116/CO3V	407	5.025,00
FG 116/CO4V	407	6.125,00
FG 116/CO15V	408	3.060,00
FG 116/CO14V	408	2.540,00
FG 116/CO16V	408	3.505,00
FG 116/CO17V	408	2.985,00
FG 116/CO30V	409	8.070,00
FG 116/CO32V	409	9.890,00
FG 116V/207A	411	1.830,00

CODICE	PAGINA	€/Pz
FG 116V/138A	411	1.280,00
FG 116/50AN	411	950,00
FG 116/207B	411	1.040,00
FG 116/138B	411	760,00
FG 116V/68A	411	715,00
FG 116V/68B	412	960,00
FG 116V/68C	412	1.050,00
FG 116V/68D	412	930,00
FG 116M/68E	412	1.180,00
FG 116V/68F	412	1.160,00
FG 116V/68G	412	1.040,00
FG 116/68V5	413	790,00
FG 116/68V6	413	820,00
FG 116/68V7	413	850,00
FG 116V/5G	413	750,00
FG 116V/6G	413	780,00
FG 116V/7G	413	800,00
FG 117/A	328	450,00
FG 118/AS76	329	870,40
FG 118/AS40	329	1.083,40
FG 118/AS56	330	780,90
FG 118/AS44	330	589,60
FG 118/AS75	331	592,30
FG 118/AS47	331	488,00
FG 118/CO1V	384	6.110,00
FG 118/CO1B	384	6.110,00
FG 118/CO1R	384	6.110,00
FG 118/CO2V	384	5.840,00
FG 118/CO2B	384	5.840,00
FG 118/CO2R	384	5.840,00
FG 118/CO3V	384	6.620,00
FG 118/CO3B	384	6.620,00
FG 118/CO3R	384	6.620,00
FG 118/CO4V	385	8.560,00
FG 118/CO4B	385	8.560,00
FG 118/CO4R	385	8.560,00
FG 118/CO5V	385	7.080,00
FG 118/CO5B	385	7.080,00
FG 118/CO5R	385	7.080,00
FG 118/CO6V	385	8.580,00
FG 118/CO6B	385	8.580,00
FG 118/CO6R	385	8.580,00
FG 118/CO7V	386	4.400,00
FG 118/CO7B	386	4.400,00
FG 118/CO7R	386	4.400,00
FG 118/CO8V	386	3.770,00
FG 118/CO8B	386	3.770,00
FG 118/CO8R	386	3.770,00
FG 118/CO9V	386	5.530,00
FG 118/CO9B	386	5.530,00
FG 118/CO9R	386	5.530,00
FG 118/CO10V	387	5.240,00
FG 118/CO10B	387	5.240,00
FG 118/CO10R	387	5.240,00
FG 118/CO15V	387	3.850,00
FG 118/CO15B	387	3.850,00
FG 118/CO15R	387	3.850,00
FG 118/CO16V	387	3.440,00
FG 118/CO16B	387	3.440,00
FG 118/CO16R	387	3.440,00
FG 118/CO20V	388	14.500,00
FG 118/CO20B	388	14.500,00
FG 118/CO20R	388	14.500,00
FG 118/CO21V	389	18.030,00
FG 118/CO21B	389	18.030,00
FG 118/CO21R	389	18.030,00
FG 118V/205L	390	3.680,00

INDICE ANALITICO

CODICE	PAGINA	€/Pz
FG 118B/205L	390	3.680,00
FG 118R/205L	390	3.680,00
FG 118V/205M	390	4.650,00
FG 118B/205M	390	4.650,00
FG 118R/205M	390	4.650,00
FG 118V/205P	390	3.250,00
FG 118B/205P	390	3.250,00
FG 118R/205P	390	3.250,00
FG 118V/205Q	391	3.150,00
FG 118B/205Q	391	3.150,00
FG 118R/205Q	391	3.150,00
FG 118/LED	391	96,00
FG 118/TR	391	80,00
FG 118/NBR1	391	98,00
FG 118/NBR2	391	120,00
FG 118/NBR3	391	120,00
FG 118V/205A	393	2.750,00
FG 118B/205A	393	2.750,00
FG 118R/205A	393	2.750,00
FG 118V/205B	393	3.700,00
FG 118B/205B	393	3.700,00
FG 118R/205B	393	3.700,00
FG 118V/205C	393	2.200,00
FG 118B/205C	393	2.200,00
FG 118R/205C	393	2.200,00
FG 118V/205D	394	2.980,00
FG 118B/205D	394	2.980,00
FG 118R/205D	394	2.980,00
FG 118V/205E	394	3.950,00
FG 118B/205E	394	3.950,00
FG 118R/205E	394	3.950,00
FG 118V/205F	394	2.400,00
FG 118B/205F	394	2.400,00
FG 118R/205F	394	2.400,00
FG 118V/122A	395	1.750,00
FG 118B/122A	395	1.750,00
FG 118R/122A	395	1.750,00
FG 118V/122B	395	1.360,00
FG 118B/122B	395	1.360,00
FG 118R/122B	395	1.360,00
FG 118V/122C	395	3.500,00
FG 118B/122C	395	3.500,00
FG 118R/122C	395	3.500,00
FG 118V/80AN	396	1.380,00
FG 118B/80AN	396	1.380,00
FG 118R/80AN	396	1.380,00
FG 118V/138AN	396	1.480,00
FG 118B/138AN	396	1.480,00
FG 118R/138AN	396	1.480,00
FG 118V/80ANT	396	920,00
FG 118B/80ANT	396	920,00
FG 118R/80ANT	396	920,00
FG 118V/138ANT	397	1.020,00
FG 118B/138ANT	397	1.020,00
FG 118R/138ANT	397	1.020,00
FG 118V/205G	397	2.150,00
FG 118B/205G	397	2.150,00
FG 118R/205G	397	2.150,00
FG 118V/205H	397	2.400,00
FG 118B/205H	397	2.400,00
FG 118R/205H	397	2.400,00
FG 118V/122H	397	1.420,00
FG 118B/122H	397	1.420,00
FG 118R/122H	397	1.420,00
FG 118V/40A	398	740,00
FG 118B/40A	398	740,00
FG 118R/40A	398	740,00

CODICE	PAGINA	€/Pz
FG 118M/40B	398	1.960,00
FG 118M/40C	398	2.100,00
FG 118M/40G	398	1.960,00
FG 118M/40H	398	1.150,00
FG 118M/40D	398	900,00
FG 118V/40E	399	740,00
FG 118B/40E	399	740,00
FG 118R/40E	399	740,00
FG 118V/40F	399	740,00
FG 118B/40F	399	740,00
FG 118R/40F	399	740,00
FG 118V/69A	399	950,00
FG 118B/69A	399	950,00
FG 118R/69A	399	950,00
FG 118M/69B	399	3.400,00
FG 118M/69G	400	3.400,00
FG 118V/69E	400	950,00
FG 118B/69E	400	950,00
FG 118R/69E	400	950,00
FG 118M/69H	400	1.350,00
FG 118/AR1V	400	750,00
FG 118/AR1B	400	750,00
FG 118/AR1R	400	750,00
FG 118/AR2V	401	1.150,00
FG 118/AR2B	401	1.150,00
FG 118/AR2R	401	1.150,00
FG 118/AR3V	401	1.800,00
FG 118/AR3B	401	1.800,00
FG 118/AR3R	401	1.800,00
FG 118/69V5	402	1.160,00
FG 118/69B5	402	1.160,00
FG 118/69R5	402	1.160,00
FG 118/69V6	402	1.220,00
FG 118/69B6	402	1.220,00
FG 118/69R6	402	1.220,00
FG 118/69V7	402	1.280,00
FG 118/69B7	402	1.280,00
FG 118/69R7	402	1.280,00
FG 118V/5T	403	1.280,00
FG 118B/5T	403	1.280,00
FG 118R/5T	403	1.280,00
FG 118V/6T	403	1.340,00
FG 118B/6T	403	1.340,00
FG 118R/6T	403	1.340,00
FG 118V/7T	403	1.400,00
FG 118B/7T	403	1.400,00
FG 118R/7T	403	1.400,00
FG 119V/CO1	416	2.015,00
FG 119B/CO1	416	2.015,00
FG 119R/CO1	416	2.015,00
FG 119V/CO2	416	2.020,00
FG 119B/CO2	416	2.020,00
FG 119R/CO2	416	2.020,00
FG 119V/CO3	416	1.750,00
FG 119B/CO3	416	1.750,00
FG 119R/CO3	416	1.750,00
FG 119V/CO4	417	1.530,00
FG 119B/CO4	417	1.530,00
FG 119R/CO4	417	1.530,00
FG 119V/CO5	417	1.570,00
FG 119B/CO5	417	1.570,00
FG 119R/CO5	417	1.570,00
FG 119V/CO6	417	1.650,00
FG 119B/CO6	417	1.650,00
FG 119R/CO6	417	1.650,00
FG 119V/CO11	418	2.900,00
FG 119B/CO11	418	2.900,00

CODICE	PAGINA	€/Pz
FG 119R/CO11	418	2.900,00
FG 119V/CO12	418	2.920,00
FG 119B/CO12	418	2.920,00
FG 119R/CO12	418	2.920,00
FG 119M/CO13	418	1.540,00
FG 119V/CO14	419	2.620,00
FG 119B/CO14	419	2.620,00
FG 119R/CO14	419	2.620,00
FG 119V/CO15	419	2.360,00
FG 119B/CO15	419	2.360,00
FG 119R/CO15	419	2.360,00
FG 119V/CO16	419	2.400,00
FG 119B/CO16	419	2.400,00
FG 119R/CO16	419	2.400,00
FG 119V/CO17	420	2.500,00
FG 119B/CO17	420	2.500,00
FG 119R/CO17	420	2.500,00
FG 119V/CO21	420	3.470,00
FG 119B/CO21	420	3.470,00
FG 119R/CO21	420	3.470,00
FG 119V/CO22	420	3.470,00
FG 119B/CO22	420	3.470,00
FG 119R/CO22	420	3.470,00
FG 119V/CO23	421	3.150,00
FG 119B/CO23	421	3.150,00
FG 119R/CO23	421	3.150,00
FG 119V/CO24	421	2.890,00
FG 119B/CO24	421	2.890,00
FG 119R/CO24	421	2.890,00
FG 119V/CO25	421	2.930,00
FG 119B/CO25	421	2.930,00
FG 119R/CO25	421	2.930,00
FG 119V/CO26	422	3.050,00
FG 119B/CO26	422	3.050,00
FG 119R/CO26	422	3.050,00
FG 119V/CO31	422	4.500,00
FG 119B/CO31	422	4.500,00
FG 119R/CO31	422	4.500,00
FG 119V/CO32	422	4.170,00
FG 119B/CO32	422	4.170,00
FG 119R/CO32	422	4.170,00
FG 119V/CO33	423	4.170,00
FG 119B/CO33	423	4.170,00
FG 119R/CO33	423	4.170,00
FG 119V/CO34	423	3.530,00
FG 119B/CO34	423	3.530,00
FG 119R/CO34	423	3.530,00
FG 119V/CO35	423	3.950,00
FG 119B/CO35	423	3.950,00
FG 119R/CO35	423	3.950,00
FG 119V/CO36	424	3.700,00
FG 119B/CO36	424	3.700,00
FG 119R/CO36	424	3.700,00
FG 119/49TL	424	130,00
FG 119/73TL	424	220,00
FG 119/98TL	424	290,00
FG 119V/CO7	425	1.580,00
FG 119B/CO7	425	1.580,00
FG 119R/CO7	425	1.580,00
FG 119V/CO18	425	2.460,00
FG 119B/CO18	425	2.460,00
FG 119R/CO18	425	2.460,00
FG 119V/CO27	425	3.040,00
FG 119B/CO27	425	3.040,00
FG 119R/CO27	425	3.040,00
FG 119/RI49	427	50,00
FG 119/RI73	427	55,00

CODICE	PAGINA	€/Pz
FG 119/RI98	427	65,00
FG 119V/BA49	427	380,00
FG 119B/BA49	427	380,00
FG 119R/BA49	427	380,00
FG 119V/BA73	427	410,00
FG 119B/BA73	427	410,00
FG 119R/BA73	427	410,00
FG 119V/BA98	427	460,00
FG 119B/BA98	427	460,00
FG 119R/BA98	427	460,00
FG 119V/BC49	428	430,00
FG 119B/BC49	428	430,00
FG 119R/BC49	428	430,00
FG 119V/BC73	428	470,00
FG 119B/BC73	428	470,00
FG 119R/BC73	428	470,00
FG 119V/BC98	428	540,00
FG 119B/BC98	428	540,00
FG 119R/BC98	428	540,00
FG 119/BV98	428	350,00
FG 119/BV98-2	428	410,00
FG 119/BV98-3	429	340,00
FG 119V/C49-3B	429	850,00
FG 119B/C49-3B	429	850,00
FG 119R/C49-3B	429	850,00
FG 119V/C49-4B	429	940,00
FG 119B/C49-4B	429	940,00
FG 119R/C49-4B	429	940,00
FG 119V/C49-5B	429	1.020,00
FG 119B/C49-5B	429	1.020,00
FG 119R/C49-5B	429	1.020,00
FG 119V/C49-6B	430	1.100,00
FG 119B/C49-6B	430	1.100,00
FG 119R/C49-6B	430	1.100,00
FG 119V/C49-VB	430	1.450,00
FG 119B/C49-VB	430	1.450,00
FG 119R/C49-VB	430	1.450,00
FG 119V/C49-2	430	630,00
FG 119B/C49-2	430	630,00
FG 119R/C49-2	430	630,00
FG 119V/C49-3	430	710,00
FG 119B/C49-3	430	710,00
FG 119R/C49-3	430	710,00
FG 119V/C49-4	431	800,00
FG 119B/C49-4	431	800,00
FG 119R/C49-4	431	800,00
FG 119V/C49-V1	431	1.030,00
FG 119B/C49-V1	431	1.030,00
FG 119R/C49-V1	431	1.030,00
FG 119M/C49-V2	431	660,00
FG 119V/C73-2	432	700,00
FG 119B/C73-2	432	700,00
FG 119R/C73-2	432	700,00
FG 119V/C73-3	432	800,00
FG 119B/C73-3	432	800,00
FG 119R/C73-3	432	800,00
FG 119V/C73-4	432	900,00
FG 119B/C73-4	432	900,00
FG 119R/C73-4	432	900,00
FG 119V/C98-2	432	790,00
FG 119B/C98-2	432	790,00
FG 119R/C98-2	432	790,00
FG 119V/C98-3	433	900,00
FG 119B/C98-3	433	900,00
FG 119R/C98-3	433	900,00
FG 119V/C98-4	433	1.020,00
FG 119B/C98-4	433	1.020,00

CODICE	PAGINA	€/Pz
FG 119R/C98-4	433	1.020,00
FG 119M/C98-V	433	1.190,00
FG 119/RP40-67	434	130,00
FG 119/RP30-67	434	110,00
FG 119/RP20-67	434	85,00
FG 119/RP40-92	434	160,00
FG 119/RP30-92	434	140,00
FG 119/RP20-92	434	120,00
FG 119/RP40-116	434	170,00
FG 119/RP30-116	434	150,00
FG 119/RP20-116	434	120,00
FG 119/RP40-141	434	200,00
FG 119/RP30-141	434	175,00
FG 119/RP20-141	434	140,00
FG 119/RV40-67	435	130,00
FG 119/RV30-67	435	95,00
FG 119/RV20-67	435	90,00
FG 119/RV40-92	435	150,00
FG 119/RV30-92	435	135,00
FG 119/RV20-92	435	115,00
FG 119/RV40-116	435	180,00
FG 119/RV30-116	435	135,00
FG 119/RV20-116	435	125,00
FG 119/RV40-141	435	210,00
FG 119/RV30-141	435	160,00
FG 119/RV20-141	435	140,00
FG 119/VA20	436	2,00
FG 119/VA30	436	5,00
FG 119/VA40	436	13,00
FG 119/D20	436	9,00
FG 119/D30	436	12,00
FG 119/D40	436	14,00
FG 119/M40-23	437	132,00
FG 119/M40-40	437	194,00
FG 119/M40-56	437	268,00
FG 119/M30-23	437	116,00
FG 119/M30-40	437	167,00
FG 119/M20-23	437	87,00
FG 119/M20-40	437	130,00
FG 119/MRT20-9	437	66,00
FG 119/MRT30-9	437	74,00
FG 119/MRT40-9	437	81,00
FG 119/BL	438	850,00
FG 119/PM	438	1.250,00
FG 119/BIN178	438	16,00
FG 119/BIN330	438	21,00
FG 119/BIN483	438	25,00
FG 119/BIN635	438	32,00
FG 119/BIN787	438	36,00
FG 119/BIN940	438	55,00
FG 119/BIN3000	438	92,00
FG 119/BP1000	438	140,00
FG 119/BP1300	438	160,00
FG 119/BP1750	438	170,00
FG 119/ROT3000	438	125,00
FG 119/C75-A	439	17,00
FG 119/C150-A	439	21,00
FG 119/C100-B	439	18,00
FG 119/C200-B	439	18,00
FG 119/C100-C	439	26,00
FG 119/C200-C	439	33,00
FG 119/ROL3000	439	150,00
FG 119/C400D	439	32,00
FG 119/PF1760	439	190,00
FG 119/PF2300	439	210,00
FG 119/TE1	439	10,00
FG 119/TE2	439	8,00

CODICE	PAGINA	€/Pz
FG 119/PC1350	439	160,00
FG 119/PC1600	439	170,00
FG 119/PC1850	439	190,00
FG 119/PC2100	439	200,00
FG 119/IP1	439	6,50
FG 119/BIN-T	439	6,00
FG 119/PR	440	75,00
FG 119/P123	440	388,00
FG 119/P124	440	660,00
FG 119/P125	440	733,60
FG 119/P126	440	733,60
FG 119/P127	440	800,80
FG 119/P128	440	800,80
FG 119/P129	440	988,00
FG 119/P130	440	1072,80
FG 119/P131	440	988,00
FG 119/P132	440	1072,80
FG 119/P133	440	1199,20
FG 119/P134	440	1199,20
FG 119/P135	440	1220,00
FG 119/P136	440	1220,00
FG 119/P137	440	1376,00
FG 119/P138	440	1376,00
FG 119/P139	440	1524,80
FG 119/P140	440	1524,80
FG 119/P150	440	699,20
FG 119/P151	440	741,60
FG 119/P152	440	908,80
FG 119/P153	440	982,40
FG 119/P154	440	1056,80
FG 119/P155	440	1199,20
FG 119/P156	440	1199,20
FG 119/P157	440	1220,00
FG 119/P158	440	1220,00
FG 119/P159	440	1376,00
FG 119/P160	440	1376,00
FG 119/P161	440	1524,80
FG 119/P162	440	1524,80
FG 119/P172	440	699,20
FG 119/P173	440	741,60
FG 119/P174	440	908,80
FG 119/P175	440	982,40
FG 119/P176	440	1056,80
FG 119/P177	440	1199,20
FG 119/P178	440	1199,20
FG 119/P179	440	1220,00
FG 119/P180	440	1220,00
FG 119/P181	440	1376,00
FG 119/P182	440	1376,00
FG 119/P183	440	1524,80
FG 119/P184	440	1524,80
FG 119/P194	440	699,20
FG 119/P195	440	741,60
FG 119/P196	440	908,80
FG 119/P197	440	982,40
FG 119/P198	440	1056,80
FG 119/P199	440	1179,20
FG 119/P200	440	1179,20
FG 119/P201	440	1295,20
FG 119/P202	440	1295,20
FG 119/P203	440	1446,40
FG 119/P204	440	1446,40
FG 119/P205	440	1446,40
FG 119/P206	440	1446,40
FG 119/P207	440	1597,60
FG 119/P208	440	1597,60
FG 119/P209	440	1199,20

CODICE	PAGINA	€/Pz
FG 119/P210	440	1199,20
FG 119/P211	440	1220,00
FG 119/P212	440	1220,00
FG 119/P213	440	1376,00
FG 119/P214	440	1376,00
FG 119/P215	440	1524,80
FG 119/P216	440	1524,80
FG 119/P226	440	659,20
FG 119/P227	440	988,00
FG 119/P228	440	1072,80
FG 119/P229	440	988,00
FG 119/P230	440	1072,80
FG 119/P231	440	1179,20
FG 119/P232	440	1179,20
FG 119/P233	440	1295,20
FG 119/P234	440	1295,20
FG 119/P235	440	1446,40
FG 119/P236	440	1446,40
FG 119/P237	440	1446,40
FG 119/P238	440	1446,40
FG 119/P239	440	1597,60
FG 119/P240	440	1597,60
FG 119/P250	440	857,60
FG 119/P251	440	1179,20
FG 119/P252	440	1295,20
FG 119/P253	440	1295,20
FG 119/P254	440	1446,40
FG 119/P255	440	1446,40
FG 119/P256	440	1446,40
FG 119/P257	440	1446,40
FG 119/P258	440	1597,60
FG 119/P259	440	1597,60
FG 119/P269	440	801,60
FG 119/P270	440	928,80
FG 119/P271	440	980,80
FG 119/P272	440	1029,60
FG 119/P273	440	1183,20
FG 119/P274	440	1337,60
FG 119/P275	440	1337,60
FG 119/P276	440	1183,20
FG 119/P277	440	1337,60
FG 119/P278	440	1337,60
FG 119/P279	440	1577,60
FG 119/P280	440	1577,60
FG 119/P281	440	1671,20
FG 119/P282	440	1671,20
FG 119/P292	440	724,80
FG 119/P293	440	786,40
FG 119/P294	440	989,60
FG 119/P295	440	989,60
FG 119/P296	440	989,60
FG 119/P297	440	1073,60
FG 119/P298	440	1073,60
FG 119/P299	440	1073,60
FG 119/P300	440	1073,60
FG 119/P301	440	1380,80
FG 119/P302	440	1380,80
FG 119/P303	440	1577,60
FG 119/P304	440	1577,60
FG 119/P305	440	1694,40
FG 119/P306	440	1694,40
FG 119/P307	440	1380,80
FG 119/P308	440	1577,60
FG 119/P309	440	1577,60
FG 119/P310	440	1694,40
FG 119/P311	440	1694,40
FG 119/P321	440	1380,80

CODICE	PAGINA	€/Pz
FG 119/P322	440	1380,80
FG 119/P323	440	1577,60
FG 119/P324	440	1577,60
FG 119/P325	440	1707,20
FG 119/P326	440	1707,20
FG 119/P327	440	1380,80
FG 119/P328	440	1577,60
FG 119/P329	440	1577,60
FG 119/P330	440	1707,20
FG 119/P331	440	1707,20
FG 119/P341	440	677,60
FG 119/P342	440	734,40
FG 119/P343	440	786,40
FG 119/P344	440	992,00
FG 119/P345	440	1069,60
FG 119/P346	440	992,00
FG 119/P347	440	1069,60
FG 119/P348	440	1286,40
FG 119/P349	440	1286,40
FG 119/P350	440	1390,40
FG 119/P351	440	1399,20
FG 119/P352	440	1308,00
FG 119/P353	440	1321,60
FG 119/P354	440	1439,20
FG 119/P355	440	1452,00
FG 119/P356	440	1633,60
FG 119/P366	440	1185,60
FG 119/P367	440	1306,40
FG 119/P368	440	1401,60
FG 119/P369	440	1401,60
FG 119/P370	440	1666,40
FG 119/P371	440	1666,40
FG 119/P372	440	1769,60
FG 119/P373	440	1769,60
FG 119/P383	440	699,20
FG 119/P384	440	741,60
FG 119/P385	440	908,80
FG 119/P386	440	984,80
FG 119/P387	440	1143,20
FG 119/P388	440	745,60
FG 119/R523	440	639,20
FG 119/R524	440	735,20
FG 119/R525	440	735,20
FG 119/R526	440	837,60
FG 119/R527	440	837,60
FG 119/R528	440	837,60
FG 119/R529	440	966,40
FG 119/R530	440	919,20
FG 119/R531	440	1094,40
FG 119/R532	440	1095,20
FG 119/R533	440	1156,80
FG 119/R534	440	1280,00
FG 119/R535	440	1305,60
FG 119/R536	440	1510,40
FG 119/R537	440	1562,40
FG 119/R538	440	1709,60
FG 119/R539	440	1760,80
FG 119/R549	440	709,60
FG 119/R550	440	709,60
FG 119/R551	440	761,60
FG 119/R552	440	837,60
FG 119/R553	440	966,40
FG 119/R554	440	1095,20
FG 119/R555	440	1156,80
FG 119/R556	440	1280,00
FG 119/R557	440	1305,60
FG 119/R558	440	1510,40

CODICE	PAGINA	€/Pz
FG 119/R559	440	1562,40
FG 119/R560	440	1709,60
FG 119/R561	440	1760,80
FG 119/R571	440	709,60
FG 119/R572	440	709,60
FG 119/R573	440	761,60
FG 119/R574	440	837,60
FG 119/R575	440	966,40
FG 119/R576	440	1095,20
FG 119/R577	440	1095,20
FG 119/R578	440	1280,00
FG 119/R579	440	1305,60
FG 119/R580	440	1510,40
FG 119/R581	440	1562,40
FG 119/R582	440	1709,60
FG 119/R583	440	1760,80
FG 119/R593	440	709,60
FG 119/R594	440	709,60
FG 119/R595	440	761,60
FG 119/R596	440	837,60
FG 119/R597	440	966,40
FG 119/R598	440	1091,20
FG 119/R599	440	1133,60
FG 119/R600	440	1305,60
FG 119/R601	440	1382,40
FG 119/R602	440	1510,40
FG 119/R603	440	1562,40
FG 119/R604	440	1510,40
FG 119/R605	440	1562,40
FG 119/R606	440	1709,60
FG 119/R607	440	1760,80
FG 119/R608	440	1095,20
FG 119/R609	440	1156,80
FG 119/R610	440	1280,00
FG 119/R611	440	1305,60
FG 119/R612	440	1510,40
FG 119/R613	440	1562,40
FG 119/R614	440	1709,60
FG 119/R615	440	1760,80
FG 119/R625	440	709,60
FG 119/R627	440	804,80
FG 119/R628	440	887,20
FG 119/R629	440	954,40
FG 119/R630	440	1020,00
FG 119/R631	440	1091,20
FG 119/R632	440	1133,60
FG 119/R633	440	1305,60
FG 119/R634	440	1382,40
FG 119/R635	440	1510,40
FG 119/R636	440	1510,40
FG 119/R637	440	1562,40
FG 119/R638	440	1709,60
FG 119/R639	440	1760,80
FG 119/R649	440	847,20
FG 119/R656	440	1091,20
FG 119/R658	440	1305,60
FG 119/R659	440	1382,40
FG 119/R660	440	1510,40
FG 119/R661	440	1562,40
FG 119/R662	440	1510,40
FG 119/R663	440	1562,40
FG 119/R664	440	1709,60
FG 119/R665	440	1760,80
FG 119/R675	440	709,60
FG 119/R676	440	997,60
FG 119/R677	440	1023,20
FG 119/R678	440	1048,80

CODICE	PAGINA	€/Pz
FG 119/R679	440	1382,40
FG 119/R681	440	1433,60
FG 119/R682	440	1433,60
FG 119/R683	440	1382,40
FG 119/R684	440	1433,60
FG 119/R685	440	1433,60
FG 119/R686	440	1632,80
FG 119/R687	440	1632,80
FG 119/R688	440	1812,00
FG 119/R689	440	1812,00
FG 119/R699	440	815,20
FG 119/R700	440	994,40
FG 119/R701	440	1046,40
FG 119/R702	440	1046,40
FG 119/R703	440	1046,40
FG 119/R704	440	1036,80
FG 119/R705	440	1036,80
FG 119/R706	440	1088,00
FG 119/R707	440	1433,60
FG 119/R708	440	1510,40
FG 119/R709	440	1632,80
FG 119/R710	440	1709,60
FG 119/R711	440	1831,20
FG 119/R712	440	1959,20
FG 119/R713	440	1510,40
FG 119/R714	440	1632,80
FG 119/R715	440	1709,60
FG 119/R716	440	1831,20
FG 119/R717	440	1959,20
FG 119/R727	440	1433,60
FG 119/R728	440	1510,40
FG 119/R729	440	1632,80
FG 119/R730	440	1709,60
FG 119/R731	440	1831,20
FG 119/R732	440	1959,20
FG 119/R733	440	1510,40
FG 119/R734	440	1632,80
FG 119/R735	440	1709,60
FG 119/R736	440	1831,20
FG 119/R737	440	1959,20
FG 119/R747	440	639,20
FG 119/R748	440	639,20
FG 119/R749	440	709,60
FG 119/R750	440	888,80
FG 119/R751	440	1043,20
FG 119/R752	440	966,40
FG 119/R753	440	1094,40
FG 119/R754	440	1382,40
FG 119/R755	440	1382,40
FG 119/R756	440	1433,60
FG 119/R757	440	1442,40
FG 119/R758	440	1404,80
FG 119/R759	440	1417,60
FG 119/R760	440	1482,40
FG 119/R761	440	1495,20
FG 119/R762	440	1784,00
FG 119/R772	440	1305,60
FG 119/R773	440	1433,60
FG 119/R774	440	1690,40
FG 119/R775	440	1690,40
FG 119/R776	440	2145,60
FG 119/R777	440	2145,60
FG 119/R778	440	2472,00
FG 119/R779	440	2472,00
FG 119/R789	440	709,60
FG 119/R790	440	633,60
FG 119/R791	440	867,20

CODICE	PAGINA	€/Pz
FG 119/R792	440	909,60
FG 119/R793	440	998,40
FG 119/R794	440	475,20
FG 121/B100	302	275,00
FG 121/B125	302	380,00
FG 121/B150	302	480,00
FG 121/B175	302	700,00
FG 125/B400	207	26,00
FG 125/A1	302	15,00
FG 125/A2	302	21,00
FG 125/A3	302	25,50
FG 125/S3	302	68,00
FG 125/L500	303	21,00
FG 125/L700	303	27,00
FG 126/SN1	135	12,50
FG 126/SN2	135	14,50
FG 126/SN3	135	23,50
FG 126/SN4	135	32,50
FG 126/SN5	135	44,00
FG 126/SN4S	135	42,00
FG 126/SN5S	135	54,00
FG 126SH/SN4	135	9,50
FG 126SH/SN5	135	9,50
FG 126/SL1	136	7,50
FG 126/SL2	136	8,50
FG 126/VP	209	22,50
FG 126/P500	210	46,50
FG 126/A300	210	19,00
FG 126/A500	210	34,00
FG 126/A600	210	43,50
FG 127/P1	135	18,00
FG 127/P1S	135	28,00
FG 127SH/P1	135	10,50
FG 127/BE1	136	8,60
FG 127/BE2	136	9,00
FG 127/BE3	136	9,45
FG 127/BE4	136	13,50
FG 127/BE7	136	21,00
FG 127/BE7S	136	29,00
FG 127SH/BE5-8	136	8,50
FG 127/PU1	136	11,50
FG 127/PU2	136	13,50
FG 127/PU2S	136	21,00
FG 127SH/PU2	136	7,50
FG 127/S1	136	49,50
FG 128/S20	136	13,50
FG 128/U5	136	8,00
FG 128/BU	136	26,00
FG 128/BU2	136	8,50
FG 128C/S6	137	46,50
FG 128P/S6	137	41,50
FG 128/CA2	137	8,50
FG 128/CA3	137	8,50
FG 128/CA4	137	10,00
FG 128/CA5	137	10,50
FG 128/CA6	137	14,00
FG 128/CA7	137	14,00
FG 128/CA8	137	15,00
FG 128/S11	137	119,50
FG 128/2	372	700,00
FG 128/D2	372	950,00
FG 128/B2	372	950,00
FG 128/R2	372	950,00
FG 128/GR2	377	1.500,00
FG 128/BR2	377	1.500,00
FG 128/RR2	377	1.500,00
FG 129/S20	136	12,50

CODICE	PAGINA	€/Pz
FG 129/C2	137	7,50
FG 129/C3	137	7,50
FG 129/C4	137	8,00
FG 129/C5	137	8,00
FG 129/C6	137	9,00
FG 129/C8	137	9,50
FG 129/C10	137	11,50
FG 129C/S6	137	54,00
FG 129/P1	137	6,90
FG 129/P2	137	6,90
FG 129/P3	137	7,80
FG 129/P4	137	7,80
FG 129/P5	137	7,80
FG 129/P6	137	7,80
FG 129P/S6	137	46,50
FG 129/S125	137	12,50
FG 129/S150	137	15,00
FG 129/S170	137	19,50
FG 129/2	372	850,00
FG 129/D2	372	1.100,00
FG 129/B2	372	1.100,00
FG 129/R2	372	1.100,00
FG 129/1	373	550,00
FG 129/D1	373	690,00
FG 129/B1	373	690,00
FG 129/R1	373	690,00
FG 129/1.5	373	650,00
FG 129/D1.5	373	790,00
FG 129/B1.5	373	790,00
FG 129/R1.5	373	790,00
FG 129/LD2	376	980,00
FG 129/LB2	376	980,00
FG 129/LR2	376	980,00
FG 129/GR1	377	160,00
FG 129/BR1	377	160,00
FG 129/RR1	377	160,00
FG 129/GR1.5	377	225,00
FG 129/BR1.5	377	225,00
FG 129/RR1.5	377	225,00
FG 130/TP	273	39,50
FG 130/TQ	273	45,50
FG 130/TZQ	273	47,50
FG 130/TPP	273	41,50
FG 130/S10	274	598,00
FG 130AL/S5	274	36,50
FG 130/A1	378	1.220,00
FG 130/D1	379	850,00
FG 131/TR	273	47,50
FG 131/TV	273	47,50
FG 131/TB	273	43,50
FG 131/TC	273	47,50
FG 131/PL9	273	115,50
FG 131/PL12	273	122,00
FG 131/PL9R	273	58,00
FG 131/PL12R	273	64,00
FG 131/PL	273	58,00
FG 131/SC	274	60,00
FG 131/SCZ	274	51,50
FG 131/SCP	274	91,00
FG 131/SCG	274	111,50
FG 131/D2	374	1.700,00
FG 131/B2	374	1.700,00
FG 131/R2	374	1.700,00
FG 131/FD2	376	1.800,00
FG 131/FB2	376	1.800,00
FG 131/FR2	376	1.800,00
FG 131/A1	378	1.350,00

CODICE	PAGINA	€/Pz
FG 131/D1	379	1.000,00
FG 132/H200	134	14,00
FG 132/H300	134	16,00
FG 132/H500	134	20,00
FG 132/H800	134	26,00
FG 132/H1000	134	29,00
FG 132/H1500	134	36,00
FG 132/H200-M	134	5,70
FG 132/H300-M	134	6,50
FG 132/H500-M	134	7,50
FG 132/H800-M	134	8,70
FG 132/H1000-M	134	9,00
FG 132/H1500-M	134	9,80
FG 132/200	134	18,50
FG 132/300	134	20,50
FG 132/500	134	21,50
FG 132/800	134	27,00
FG 132/1000	134	29,50
FG 132/E200	134	15,00
FG 132/D2	374	2.350,00
FG 132/B2	374	2.350,00
FG 132/R2	374	2.350,00
FG 132/FD2	376	2.400,00
FG 132/FB2	376	2.400,00
FG 132/FR2	376	2.400,00
FG 133/H340	134	25,50
FG 133/H540	134	32,50
FG 133/H910	134	37,50
FG 133/D2	375	2.300,00
FG 133/B2	375	2.300,00
FG 133/R2	375	2.300,00
FG 134/H800	134	22,00
FG 134/H1000	134	23,00
FG 134/H1250	134	25,50
FG 134/H1500	134	29,50
FG 134/H2000	134	36,00
FG 134/H800-M	134	6,70
FG 134/H1000-M	134	6,70
FG 134/H1250-M	134	7,20
FG 134/H1500-M	134	7,20
FG 134/H2000-M	134	8,00
FG 134/R300	134	36,00
FG 134/R500	134	55,00
FG 134/R800	134	82,00
FG 134/R1000	134	98,00
FG 134/D2	375	3.000,00
FG 134/B2	375	3.000,00
FG 134/R2	375	3.000,00
FG 135/45	134	33,00
FG 135/50	134	34,00
FG 135/60	134	46,50
FG 135/D2	375	3.600,00
FG 135/B2	375	3.600,00
FG 135/R2	375	3.600,00
FG 136/L22-M	135	5,30
FG 136/L28-M	135	5,30
FG 136/L35-M	135	6,20
FG 136/L42-M	135	6,40
FG 136/L50-M	135	7,40
FG 136/L60-M	135	8,20
FG 136L/R22	135	3,10
FG 136L/R28	135	4,80
FG 136L/R35	135	6,00
FG 136L/R42	135	11,00
FG 136L/R50	135	14,90
FG 136L/R60	135	18,00
FG 136/30	135	52,00

CODICE	PAGINA	€/Pz
FG 136/40	135	65,00
FG 136/50	135	75,00
FG 136/R30	135	8,80
FG 136/R40	135	10,80
FG 136/R50	135	16,50
FG 136/L22	135	20,00
FG 136/L28	135	25,00
FG 136/L35	135	33,00
FG 136/L42	135	52,00
FG 136/L50	135	70,00
FG 136/L60	135	85,00
FG 136/D1.5	378	1.250,00
FG 136/B1.5	378	1.250,00
FG 136/R1.5	378	1.250,00
FG 137/TRX7	93	4,70
FG 137/TRX8	93	4,70
FG 137/TRX9	93	4,70
FG 137/TRX10	93	4,70
FG 137/TRX15	93	4,80
FG 137/TRX20	93	4,80
FG 137/TRX25	93	4,90
FG 137/TRX27	93	5,00
FG 137/TRX30	93	5,40
FG 137/TRX40	93	6,10
FG 137/TRX45	93	6,10
FG 137/TRX50	93	6,80
FG 137	93	58,00
FG 137/D1.5	378	1.400,00
FG 137/B1.5	378	1.400,00
FG 137/R1.5	378	1.400,00
FG 138/TX7	92	4,20
FG 138/TX8	92	4,20
FG 138/TX9	92	4,20
FG 138/TX10	92	4,30
FG 138/TX15	92	4,30
FG 138/TX20	92	4,30
FG 138/TX25	92	4,50
FG 138/TX27	92	4,60
FG 138/TX30	92	5,20
FG 138/TX40	92	5,60
FG 138/TX45	92	7,80
FG 138/TX50	92	8,20
FG 138	92	55,00
FG 138C/FS	92	31,00
FG 138/S9	93	26,00
FG 138/B	93	34,00
FG 138/C	93	37,00
FG 138/M	93	60,00
FG 138BP/TX8	93	4,80
FG 138BP/TX9	93	4,80
FG 138BP/TX10	93	4,90
FG 138BP/TX15	93	4,90
FG 138BP/TX20	93	5,00
FG 138BP/TX25	93	5,10
FG 138BP/TX27	93	5,20
FG 138BP/TX30	93	5,50
FG 138BP/TX40	93	6,20
FG 138BP/TX45	93	8,40
FG 138BP/TX50	93	8,90
FG 138/BP	93	60,00
FG 139/B1.5	90	0,50
FG 139/B2	90	0,50
FG 139/B2.5	90	0,60
FG 139/B3	90	0,60
FG 139/B4	90	0,70
FG 139/B4.5	90	0,70
FG 139/B5	90	0,80

CODICE	PAGINA	€/Pz
FG 139/B5.5	90	0,80
FG 139/B6	90	1,40
FG 139/B7	90	1,70
FG 139/B8	90	1,80
FG 139/B9	90	2,20
FG 139/B10	90	2,70
FG 139/B11	90	4,00
FG 139/B12	90	5,70
FG 139/B13	90	5,80
FG 139/B14	90	8,30
FG 139/B16	90	9,30
FG 139/B17	90	12,90
FG 139/B19	90	18,10
FG 139/B22	90	27,90
FG 139/B24	90	33,00
FG 139/B27	90	43,30
FG 139/B30	90	67,00
FG 139/B32	90	92,70
FG 139/B36	90	123,60
FG 139/B	90	16,50
FG 139/C1.5	90	0,90
FG 139/C2	90	1,00
FG 139/C2.5	90	1,10
FG 139/C3	90	1,20
FG 139/C4	90	1,50
FG 139/C4.5	90	1,70
FG 139/C5	90	1,70
FG 139/C5.5	90	1,80
FG 139/C6	90	2,20
FG 139/C7	90	2,70
FG 139/C8	90	3,30
FG 139/C10	90	5,40
FG 139/C12	90	7,10
FG 139/C14	90	9,80
FG 139/C17	90	18,10
FG 139/C19	90	18,40
FG 139/C	90	23,70
FG 139/LM	91	52,00
FG 139/1.5	91	1,50
FG 139/2	91	1,60
FG 139/2.5	91	1,60
FG 139/3	91	1,60
FG 139/4	91	1,80
FG 139/4.5	91	2,10
FG 139/5	91	2,10
FG 139/5.5	91	2,90
FG 139/6	91	2,90
FG 139/7	91	4,00
FG 139/8	91	5,10
FG 139/10	91	6,00
FG 139	91	36,00
FG 139C/FS	91	24,00
FG 139/L1.5	91	2,20
FG 139/L2	91	2,30
FG 139/L2.5	91	2,30
FG 139/L3	91	2,40
FG 139/L4	91	2,70
FG 139/L4.5	91	3,30
FG 139/L5	91	3,30
FG 139/L5.5	91	3,30
FG 139/L6	91	4,20
FG 139/L7	91	4,40
FG 139/L8	91	4,60
FG 139/L10	91	6,60
FG 139/L12	91	8,80
FG 139/L14	91	14,00
FG 139/L17	91	22,20

CODICE	PAGINA	€/Pz
FG 139/L19	91	28,90
FG 139/L	91	40,00
FG 139IN/0.05	92	0,90
FG 139/IN	92	38,00
FG 139FS/IN	92	24,00
FG 139/S9	94	41,00
FG 139/D1.5	94	0,80
FG 139/D2	94	0,80
FG 139/D2.5	94	0,80
FG 139/D3	94	1,00
FG 139/D4	94	1,10
FG 139/D4.5	94	1,10
FG 139/D5	94	1,40
FG 139/D5.5	94	1,60
FG 139/D6	94	1,60
FG 139/D7	94	2,10
FG 139/D8	94	2,40
FG 139/D9	94	2,90
FG 139/D10	94	3,70
FG 139/D11	94	4,60
FG 139/D12	94	5,20
FG 139/D13	94	6,70
FG 139/D14	94	7,50
FG 139/D16	94	11,40
FG 139/D17	94	11,90
FG 139/D19	94	16,00
FG 139/D22	94	24,30
FG 139/D24	94	30,90
FG 139/D27	94	42,80
FG 139/D30	94	54,10
FG 139/D32	94	76,30
FG 139/D36	94	108,20
FG 139/D	94	21,70
FG 139/E1.5	94	1,50
FG 139/E2	94	1,50
FG 139/E2.5	94	1,70
FG 139/E3	94	1,70
FG 139/E4	94	1,90
FG 139/E5	94	2,30
FG 139/E5.5	94	2,50
FG 139/E6	94	2,50
FG 139/E7	94	2,70
FG 139/E8	94	3,30
FG 139/E10	94	5,10
FG 139/E12	94	6,70
FG 139/E14	94	9,50
FG 139/E17	94	16,00
FG 139/E19	94	22,20
FG 139/E	94	33,00
FG 139/B2.5	197	0,60
FG 139/B3	197	0,60
FG 139/3	199	1,60
FG 142/2	97	9,60
FG 142/2.5	97	10,20
FG 142/3	97	11,00
FG 142/4	97	12,20
FG 142/5	97	13,20
FG 142/6	97	15,00
FG 142/7	97	15,30
FG 142/8	97	16,50
FG 142/10	97	18,00
FG 142/S9	97	125,00
FG 143/TX7	97	10,20
FG 143/TX8	97	10,20
FG 143/TX9	97	10,20
FG 143/TX10	97	10,50
FG 143/TX15	97	11,00

CODICE	PAGINA	€/Pz
FG 143/TX20	97	11,80
FG 143/TX25	97	12,60
FG 143/TX27	97	13,20
FG 143/TX30	97	13,90
FG 143/TX40	97	15,80
FG 143/TX45	97	18,50
FG 143/TX50	97	21,50
FG 143TX/S6	97	80,00
FG 143TX/S12	97	165,00
FG 147/TX9	42	8,50
FG 147/TX10	42	8,50
FG 147/TX15	42	8,50
FG 147/TX20	42	8,50
FG 147/TX25	42	8,50
FG 147/TX27	42	8,50
FG 147/TX30	42	8,50
FG 147/TX40	42	8,50
FG 147TX/S8	42	73,50
FG 147/PT10	42	10,00
FG 147/PT15	42	10,00
FG 147/PT20	42	10,00
FG 147/PT25	42	10,00
FG 147/PT27	42	10,00
FG 147/PT30	42	10,00
FG 147PT/S6	42	66,50
FG 147/H2.5	42	6,50
FG 147/H3	42	6,50
FG 147/H4	42	6,50
FG 147/H5	42	6,50
FG 147/H6	42	6,50
FG 147/H7	42	6,50
FG 147/H8	42	6,50
FG 147/H10	42	6,50
FG 147H/S8	42	61,00
FG 147/PH1	43	6,50
FG 147/PH2	43	6,50
FG 147/PH3	43	6,50
FG 147/PH4	43	6,50
FG 147/SL4	43	6,50
FG 147/SL5.5	43	6,50
FG 147/SL6.5	43	6,50
FG 147/SL8	43	6,50
FG 147/SL10	43	6,50
FG 149/TX9	51	11,50
FG 149/TX10	51	11,50
FG 149/TX15	51	11,50
FG 149/TX20	51	11,50
FG 149/TX25	51	11,50
FG 149/TX27	51	11,50
FG 149/TX30	51	11,50
FG 149/TX40	51	11,50
FG 149TX/S8	51	94,50
FG 149TX/S8B	51	100,00
FG 149/H3	51	7,00
FG 149/H4	51	7,00
FG 149/H5	51	7,00
FG 149/H6	51	7,00
FG 149/H7	51	7,00
FG 149/H8	51	7,00
FG 149/H10	51	7,00
FG 149H/S7	51	55,00
FG 149/PT40	51	10,00
FG 149/PT45	51	10,00
FG 149/PT50	51	10,00
FG 149/SL5.5	52	7,00
FG 149/SL6.5	52	7,00
FG 149/SL8	52	7,00

CODICE	PAGINA	€/Pz
FG 149/SL10	52	7,00
FG 149/PH1	52	7,00
FG 149/PH2	52	7,00
FG 149/PH3	52	7,00
FG 149/PH4	52	7,00
FG 149PF/S8	52	59,00
FG 149E/H4	114	18,60
FG 149E/H5	114	18,80
FG 149E/H6	114	19,00
FG 149E/H8	114	22,20
FG 149E/S4	115	92,00
FG 150/TX6	60	13,50
FG 150/TX7	60	13,50
FG 150/TX8	60	13,50
FG 150/TX9	60	13,50
FG 150/TX10	60	13,50
FG 150/TX15	60	13,50
FG 150/TX20	60	13,50
FG 150/TX25	60	13,50
FG 150/TX27	60	13,50
FG 150/TX30	60	14,00
FG 150/TX40	60	14,00
FG 150/TX45	60	14,50
FG 150/TX50	60	14,50
FG 150/TX55	60	16,00
FG 150/TX60	60	17,00
FG 150/TX70	60	17,00
FG 150L/TX20	60	16,00
FG 150L/TX25	60	16,00
FG 150L/TX27	60	16,00
FG 150L/TX30	60	16,00
FG 150L/TX40	60	16,00
FG 150L/TX45	60	16,50
FG 150L/TX50	60	16,50
FG 150L/TX55	60	17,50
FG 150L/TX60	60	17,50
FG 150L/TX70	60	19,50
FG 150XL/TX40	61	19,50
FG 150XL/TX45	61	19,50
FG 150XL/TX55	61	19,50
FG 150XL/TX60	61	26,00
FG 150XL/TX70	61	29,00
FG 150XXL/TX40	61	26,50
FG 150XXL/TX45	61	26,50
FG 150XXL/TX50	61	26,50
FG 150XXL/TX55	61	26,50
FG 150XXL/TX60	61	34,00
FG 150XXL/TX70	61	38,00
FG 150TX/S11	61	165,00
FG 150LTX/S6	61	105,50
FG 150TX/S32	61	195,00
FG 150/M5	62	13,50
FG 150/M6	62	13,50
FG 150/M8	62	13,50
FG 150/M9	62	13,50
FG 150/M10	62	13,50
FG 150/M12	62	13,50
FG 150/M14	62	13,50
FG 150/M16	62	14,50
FG 150L/M5	63	16,00
FG 150L/M6	63	16,00
FG 150L/M8	63	16,00
FG 150L/M9	63	16,00
FG 150L/M10	63	16,00
FG 150L/M12	63	16,00
FG 150L/M14	63	16,00

CODICE	PAGINA	€/Pz
FG 150XL/M5	63	19,50
FG 150XL/M6	63	19,50
FG 150XL/M8	63	19,50
FG 150XL/M9	63	19,50
FG 150XL/M10	63	19,50
FG 150XL/M12	63	26,50
FG 150XL/M14	63	29,00
FG 150XXL/M8	63	26,50
FG 150XXL/M10	63	26,50
FG 150XXL/M12	63	34,00
FG 150XXL/M14	63	38,50
FG 150M/S7	63	98,00
FG 150LM/S7	63	115,50
FG 150M/S26	63	180,00
FG 150/R4	64	13,50
FG 150/R5	64	13,50
FG 150/R6	64	13,50
FG 150/R7	64	13,50
FG 150/R8	64	13,50
FG 150/R9	64	13,50
FG 150/R10	64	13,50
FG 150/R11	64	13,50
FG 150/R12	64	13,50
FG 150/R13	64	14,00
FG 150/R14	64	14,00
FG 150R/S11	64	144,50
FG 150L/R4	64	15,00
FG 150L/R5	64	15,00
FG 150L/R6	64	15,00
FG 150L/R7	64	15,00
FG 150L/R8	64	15,00
FG 150L/R9	64	15,00
FG 150L/R10	64	15,00
FG 150L/R11	64	15,00
FG 150L/R12	64	15,00
FG 150L/R13	64	15,00
FG 150L/R14	64	15,00
FG 150/RF4	64	15,00
FG 150/RF5	64	15,00
FG 150/RF6	64	15,00
FG 150/RF7	64	15,00
FG 150/RF8	64	15,00
FG 150/RF9	64	15,00
FG 150/RF10	64	15,50
FG 150/RF11	64	15,50
FG 150/RF12	64	15,50
FG 150/RF13	64	16,00
FG 150/RF14	64	16,00
FG 150RF/S11	65	173,50
FG 150L/RF4	65	15,50
FG 150L/RF5	65	15,50
FG 150L/RF6	65	15,50
FG 150L/RF7	65	15,50
FG 150L/RF8	65	16,00
FG 150L/RF9	65	16,00
FG 150L/RF10	65	16,00
FG 150L/RF11	65	16,50
FG 150L/RF12	65	16,50
FG 150L/RF13	65	16,50
FG 150L/RF14	65	17,00
FG 150H/H2	65	12,50
FG 150H/H2,5	65	12,50
FG 150H/H3	65	12,50
FG 150H/H4	65	12,50
FG 150H/H5	65	12,50
FG 150H/H6	65	12,50
FG 150H/H8	65	12,50

CODICE	PAGINA	€/Pz
FG 150/H10	65	12,50
FG 150/H12	65	15,00
FG 150/H14	65	15,00
FG 150/H17	65	16,50
FG 150/H19	65	18,50
FG 150L/H2	65	13,00
FG 150L/H2,5	65	13,00
FG 150L/H3	65	13,00
FG 150L/H4	65	13,00
FG 150L/H5	65	13,00
FG 150L/H6	65	13,00
FG 150L/H8	65	13,00
FG 150L/H10	65	13,00
FG 150L/H11	65	15,50
FG 150L/H12	65	17,00
FG 150L/H13	65	17,00
FG 150XL/H5	66	17,00
FG 150XL/H6	66	17,00
FG 150XL/H7	66	17,00
FG 150XL/H8	66	17,00
FG 150XL/H10	66	17,00
FG 150XL/H12	66	18,00
FG 150XL/H14	66	18,00
FG 150XXL/H5	66	26,00
FG 150XXL/H6	66	26,00
FG 150XXL/H7	66	26,00
FG 150XXL/H8	66	26,00
FG 150XXL/H10	66	27,00
FG 150XXL/H12	66	31,00
FG 150H/S12	66	139,50
FG 150H/S9	66	118,50
FG 150H/S30	66	200,00
FG 150L/H5B	67	14,50
FG 150L/H6B	67	14,50
FG 150L/H7B	67	14,50
FG 150L/H8B	67	14,50
FG 150L/H10B	67	14,50
FG 150XXL/H5B	67	20,50
FG 150XXL/H6B	67	20,50
FG 150XXL/H7B	67	20,50
FG 150XXL/H8B	67	20,50
FG 150XXL/H10B	67	20,50
FG 150H/S10B	67	170,00
FG 150E/H4	113	26,80
FG 150E/H5	113	26,80
FG 150E/H6	113	26,80
FG 150E/H8	113	26,80
FG 150E/H10	113	27,90
FG 150E/LH4	113	32,50
FG 150E/LH5	113	32,50
FG 150E/LH6	113	32,50
FG 150E/LH8	113	32,50
FG 150E/LH10	113	35,00
FG 150E/S4	114	118,50
FG 150D/5G	344	1.000,00
FG 150R/5G	344	1.000,00
FG 150D/6G	344	1.050,00
FG 150R/6G	344	1.050,00
FG 150D/7G	344	1.100,00
FG 150R/7G	344	1.100,00
FG 150/PR	371	40,00
FG 150/PL	371	65,00
FG 152/RM5	67	12,50
FG 152/RM6	67	12,50
FG 152/RM8	67	12,50
FG 152/RM9	67	12,50
FG 152/RM10	67	12,50

CODICE	PAGINA	€/Pz
FG 152/RM12	67	14,00
FG 152/RM14	67	14,00
FG 152/RM16	67	14,00
FG 152/RM18	67	14,00
FG 152RM/S9	67	125,00
FG 152/RH5	67	12,50
FG 152/RH6	67	12,50
FG 152/RH7	67	12,50
FG 152/RH8	67	12,50
FG 152/RH10	67	12,50
FG 152/RH12	67	12,50
FG 152/RH14	67	14,50
FG 152/RH17	67	14,50
FG 152/RH19	67	14,50
FG 152RH/S9	68	125,00
FG 152/RTX20	68	15,00
FG 152/RTX25	68	15,00
FG 152/RTX27	68	15,00
FG 152/RTX30	68	15,00
FG 152/RTX40	68	15,00
FG 152/RTX45	68	16,00
FG 152/RTX50	68	17,00
FG 152/RTX55	68	17,00
FG 152/RTX60	68	17,00
FG 152/RTX70	68	17,00
FG 152/RTXS10	68	165,00
FG 152L/RM9	201	23,00
FG 152RM/S4	207	67,00
FG 159/PM	211	230,00
FG 159/S5	211	57,00
FG 160/1	156	108,50
FG 160/2	156	235,00
FG 160/3	156	420,00
FG 160/GL1	157	88,00
FG 160/GL2	157	108,50
FG 160/GL3	157	165,00
FG 160/GL4	157	191,00
FG 160/GL1-G1	157	17,00
FG 160/GL2-G2	157	17,00
FG 160/GL3-G3	157	30,00
FG 160/GL4-G4	157	39,00
FG 160/GL1-V1	157	22,00
FG 160/GL2-V2	157	35,00
FG 160/GL3-V3	157	49,00
FG 160/GL4-V4	157	50,00
FG 160/GL1-G1	157	17,00
FG 160/GL2-G2	157	17,00
FG 160/GL3-G3	157	30,00
FG 160/GL4-G4	157	39,00
FG 160/GL1-V1	157	22,00
FG 160/GL2-V2	157	35,00
FG 160/GL3-V3	157	49,00
FG 160/GL4-V4	157	50,00
FG 160/OS1	158	95,00
FG 160/OS2	158	139,50
FG 160/OS3	158	211,50
FG 160/OS4	158	232,00
FG 160/OS5	158	402,00
FG 160/OS1-G1	158	17,00
FG 160/OS2-G2	158	30,00
FG 160/OS3-G3	158	44,00
FG 160/OS4-G4	158	46,00
FG 160/OS5-G5	158	92,00
FG 160/OS1-V1	158	24,00
FG 160/OS2-V2	158	38,00
FG 160/OS3-V3	158	56,00
FG 160/OS4-V4	158	70,00

CODICE	PAGINA	€/Pz
FG 160/OS5-V5	158	85,00
FG 160/OS1-G1	158	17,00
FG 160/OS2-G2	158	30,00
FG 160/OS3-G3	158	44,00
FG 160/OS4-G4	158	46,00
FG 160/OS5-G5	158	92,00
FG 160/OS1-V1	158	24,00
FG 160/OS2-V2	158	38,00
FG 160/OS3-V3	158	56,00
FG 160/OS4-V4	158	70,00
FG 160/OS5-V5	158	85,00
FG 160V/14L	345	3.550,00
FG 160B/14L	345	3.550,00
FG 160R/14L	345	3.550,00
FG 160D/14L	345	3.550,00
FG 161/1	157	124,00
FG 161/2	157	250,00
FG 161/3	157	474,00
FG 161/GL1	157	108,50
FG 161/GL2	157	134,00
FG 161/GL3	157	206,00
FG 161/GL4	157	247,50
FG 161/OS1	158	144,50
FG 161/OS2	158	216,50
FG 161/OS3	158	294,00
FG 161/OS4	158	324,50
FG 161/OS5	158	644,00
FG 162/1	154	93,00
FG 162/2	154	98,00
FG 162/3	154	173,50
FG 162/4	154	201,00
FG 162/5	154	304,00
FG 162/S3	154	366,00
FG 162/1-G1	154	28,00
FG 162/2-G2	154	29,00
FG 162/3-G3	154	50,00
FG 162/4-G4	154	52,00
FG 162/5-G5	154	70,00
FG 162/1-V1	154	26,00
FG 162/2-V2	154	26,00
FG 162/3-V3	154	32,00
FG 162/4-V4	154	32,00
FG 162/5-V5	154	42,00
FG 162/ME	154	33,50
FG 162/FR1	155	149,50
FG 162/FR2	155	196,00
FG 162/FR3	155	237,00
FG 162/MA1	158	330,00
FG 162/MA3	158	525,50
FG 163/1	155	201,00
FG 163/3	155	278,50
FG 163/1-GR1	155	24,00
FG 163/3-GR3	155	33,00
FG 163/1-V1	155	29,50
FG 163/3-V3	155	38,50
FG 163/1-V1	155	29,50
FG 163/3-V3	155	38,50
FG 163/S2B	155	263,00
FG 164/1	155	196,00
FG 164/2	155	242,50
FG 164/1-GR1	155	20,00
FG 164/2-GR2	155	25,00
FG 164/S3	209	250,00
FG 164/S3B	209	170,00
FG 164/A	210	130,00
FG 164/C	210	240,00
FG 164/D	210	246,00

CODICE	PAGINA	€/Pz
FG 164/E	210	260,00
FG 164/S10	210	180,50
FG 165/1	156	298,00
FG 165/2	156	370,00
FG 165/3	156	556,00
FG 165/HI	156	978,00
FG 165/1-G1	156	33,00
FG 165/2-G2	156	44,00
FG 165/3-G3	156	64,00
FG 165/HI-G1	156	64,00
FG 165/1-V1	156	25,00
FG 165/2-V2	156	38,00
FG 165/3-V3	156	52,00
FG 165/HI-V1	156	360,00
FG 165/IE1	157	320,00
FG 165/IE2	157	760,00
FG 165/MB1	157	170,00
FG 165/MB2	157	330,00
FG 165/FC	206	49,00
FG 165/GO1	212	180,00
FG 165/GO2	212	150,00
FG 165/S26	213	700,00
FG 165/S7	213	195,00
FG 165/BC1	282	45,00
FG 165/BC2	282	43,00
FG 165/BC3	282	65,00
FG 165BC/S6	282	230,00
FG 166/1	159	72,50
FG 166/2	159	134,00
FG 166/3	159	227,00
FG 166/LT2	211	920,00
FG 166/LT	211	750,00
FG 166/BA	211	250,00
FG 166/CB	211	70,00
FG 166/S28	213	475,00
FG 166/S7	213	650,00
FG 167/1	159	64,00
FG 167/2	159	105,50
FG 167/3	159	227,00
FG 167/4	159	390,00
FG 168/EF1	154	319,50
FG 168/EF2	154	330,00
FG 168/EF1-G1	154	110,00
FG 168/EF2-G2	154	115,00
FG 168/EF1-V1	154	52,00
FG 168/EF2-V2	154	62,00
FG 168/R6	160	13,50
FG 168/R7	160	13,50
FG 168/R8	160	14,50
FG 168/R9	160	15,50
FG 168/R10	160	15,50
FG 168/R10.5	160	15,50
FG 168/R12	160	15,50
FG 168/R14	160	22,00
FG 168/R16	160	23,00
FG 168/S9	160	180,00
FG 168/F1	160	3,00
FG 168/F2	160	3,00
FG 168/F3	160	4,50
FG 168/F4	160	5,00
FG 168/F5	160	5,50
FG 168/F6	160	7,50
FG 168/F7	160	13,50
FG 168/F8	160	19,00
FG 168/FS5	160	19,50
FG 168/FS8	160	62,00
FG 168EP/S5	160	33,00

CODICE	PAGINA	€/Pz
FG 168/S25	161	144,00
FG 168/SD1	161	19,00
FG 168/SD2	161	25,00
FG 168/SD3	161	34,00
FG 168/SD4	161	46,50
FG 168SD/S4	161	155,00
FG 168/A8	161	14,70
FG 168/A9	161	14,70
FG 168/A10	161	14,70
FG 168/A11	161	14,70
FG 168/A12	161	14,70
FG 168/A13	161	14,70
FG 168/A14	161	15,50
FG 168/A15	161	15,50
FG 168/A16	161	15,50
FG 168/A17	161	15,50
FG 168/A18	161	16,00
FG 168/A19	161	16,00
FG 168/A21	161	17,00
FG 168/A22	161	17,00
FG 168/A24	161	17,60
FG 168/A27	161	19,30
FG 168/A30	161	24,70
FG 168/A32	161	24,70
FG 168A/S5	161	110,00
FG 168A/S13	161	210,00
FG 168/GA	211	60,00
FG 168/E	212	98,00
FG 168/1	212	54,00
FG 168/2	212	67,00
FG 168/3	212	102,00
FG 168/4	212	135,00
FG 168/S7	212	250,00
FG 169/A44	211	57,00
FG 169/FO1	212	44,50
FG 169/FO2	212	44,50
FG 169/FO3	212	44,50
FG 169/1	212	62,00
FG 169/2	212	80,50
FG 169/3	212	144,50
FG 169/BS	213	129,00
FG 169/BS1	213	118,50
FG 169/BS3	213	118,50
FG 170/1	215	14,00
FG 170/2	215	16,00
FG 170/3	215	18,50
FG 170/S3	215	49,50
FG BEST 171	70	400,00
FG 171/N	215	30,00
FG 171/B	216	41,50
FG 171/FL	216	51,50
FG 172/BL	203	28,00
FG 172/TC	214	56,00
FG 172/CL	214	48,50
FG 172/FA	214	72,50
FG 172/FA2	214	98,00
FG 172/MA	214	98,00
FG 172/AS2	214	108,00
FG 172/AS2-A	215	26,00
FG 172/AS2-B	215	50,00
FG 172/AS2-C	215	30,00
FG 172/AS2-D	215	33,00
FG 172/GO2	215	105,00
FG 172/OT	215	56,00
FG 172/PA	215	67,00
FG 172/TG	215	49,50
FG 172/MJ	216	26,00

CODICE	PAGINA	€/Pz
FG 172/S4	216	50,00
FG 172/CA	216	58,00
FG 172/RL2	216	25,00
FG 174/F2	198	72,50
FG 174/SC	198	118,50
FG 174	216	39,50
FG 175/B1	188	9,00
FG 175/B2	188	9,00
FG 175/B3	188	9,00
FG 175/B4	188	9,00
FG 175/B5	188	9,00
FG 175/B6	188	9,00
FG 175/B7	188	9,00
FG 175/B8	188	9,00
FG 175/B9	188	9,00
FG 175/B10	188	9,50
FG 175/B11	188	9,50
FG 175/B12	188	10,00
FG 175/B13	188	10,00
FG 175/B14	188	10,00
FG 175/B15	188	10,00
FG 175/B16	188	10,00
FG 175/B17	188	10,00
FG 175/B18	188	12,00
FG 175/B19	188	12,00
FG 175/B20	188	12,00
FG 175/B21	188	20,00
FG 175/PF66	188	10,00
FG 175/PF76-12	188	10,00
FG 175/PF76-30	188	10,00
FG 175/PF86-18	188	11,00
FG 175/PF93-36	188	11,00
FG 175/PF93-45	188	11,00
FG 175/PF96-18	188	11,50
FG 175/PF108-18	188	12,50
FG 175/PF135-18	188	22,00
FG 175PF/S4	188	74,50
FG 175/S30	188	221,50
FG 175/C1	188	9,50
FG 175/C2	188	9,50
FG 175/C3	188	9,50
FG 175/C4	188	10,00
FG 175/C5	188	10,00
FG 175/C6	188	10,00
FG 175/S6	189	62,00
FG 175/F074	189	45,50
FG 175/F074.5	189	45,50
FG 175/F074.5-8	189	50,00
FG 175/F08	189	39,50
FG 175/F010	189	50,00
FG 175/F014	189	53,00
FG 175/F015	189	65,00
FG 175/F084	189	57,00
FG 175/F014M	189	35,50
FG 175/F014T	189	30,00
FG 175/Hi	189	67,00
FG 175/OP1	190	46,50
FG 175/A32	190	29,00
FG 175/XZN16	191	8,50
FG 175/S114	191	265,00
FG 175/OD13x1.25	191	3,50
FG 175/OD13x1.5	191	3,50
FG 175/OD15x1.5	191	3,50
FG 175/OD17x1.5	191	3,40
FG 175/OD20x1.5	191	3,40
FG 175/OD22x1.5	191	4,20
FG 175/W13x1.5	191	0,50

CODICE	PAGINA	€/Pz
FG 175/W15x1.5	191	0,50
FG 175/W17x1.5	191	0,60
FG 175/W20x1.5	191	0,80
FG 175/W22x1.5	191	0,90
FG 175/M13x1.25	191	16,00
FG 175/M13x1.5	191	15,00
FG 175/M15x1.5	191	16,00
FG 175/M17x1.5	191	18,50
FG 175/M20x1.5	191	19,50
FG 175/M22x1.5	191	21,50
FG 175/A8X10	192	23,00
FG 175/S15	192	135,00
FG 175/S4	192	72,50
FG 175/PO	192	14,00
FG 175/PO1	192	12,00
FG 175/PO2	192	14,00
FG 175/PO3	192	12,00
FG 175/FT1	198	67,00
FG 175/FT2	198	82,50
FG 175/FT3	198	82,50
FG 175/FT4	199	72,50
FG 175/FT5	199	72,50
FG 175/FG2	199	92,00
FG 176/RP	190	46,50
FG 176/RP2	190	49,50
FG 176/RE	190	36,50
FG 176/RE-SP	190	9,00
FG 176/NA1	190	36,50
FG 176/NA2	190	41,50
FG 176/NA1-R	190	16,00
FG 176/NA2-R	190	18,50
FG 176/F01	190	88,00
FG 176/F02	190	93,00
FG 176/F01-C	190	33,00
FG 176/F02-C	190	46,50
FG 176/CJ	191	33,00
FG 176/S13	193	445,00
FG 177/F01	190	85,00
FG 177/F01-C	190	43,00
FG 178/SD	191	140,00
FG 178/3L	191	30,00
FG 178/UF110	191	115,00
FG 178/UF145	191	165,00
FG 178/UF	192	60,00
FG 178/20L	192	95,00
FG 178/P1	193	85,00
FG 178/P2	193	110,00
FG 178/SF	205	1.820,00
FG 178SF/AD13	205	60,00
FG 178SF/AD14	205	60,00
FG 178/S6	205	330,00
FG 178/BF	206	255,00
FG 179/H28	204	13,50
FG 179/H32	204	15,50
FG 179/PA20	204	16,00
FG 179/T50	204	30,00
FG 179/H10	204	25,00
FG 179/GP	204	30,00
FG 179/S16	204	160,00
FG 179/S16-1	204	36,50
FG 179/GP	204	30,00
FG 179/H10	204	25,00
FG 179/T50	204	30,00
FG 179/S16-5	204	40,20
FG 179/S16-6	204	4,60
FG 179/S16-7	204	4,60
FG 179/S16-8	204	4,60

CODICE	PAGINA	€/Pz
FG 179/S16-9	204	4,60
FG 179/S16-10	204	4,60
FG 179/S16-11	204	4,60
FG 179/S16-12	204	13,50
FG 179/S16-13	204	3,00
FG 179/S16-14	204	3,00
FG 179/S16-15	204	7,50
FG 179/S16-16	204	7,50
FG 180/A6x8	27	13,50
FG 180/A8x10	27	14,00
FG 180/A9X11	27	15,50
FG 180/A10X11	27	15,50
FG 180/A11X13	27	17,00
FG 180/A12X14	27	19,00
FG 180/A13X14	27	21,50
FG 180/B14X15	27	21,50
FG 180/B14X17	27	23,00
FG 180/B17X19	27	24,50
FG 180/B19X22	27	26,00
FG 180/B22X24	27	32,00
FG 180/B24x27	27	33,50
FG 180/B30x32	27	42,50
FG 180/B36X41	27	70,00
FG 180/IN1	27	11,30
FG 180/IN2	27	12,00
FG 180/IN3	27	13,00
FG 180/IN4	27	16,00
FG 180/IN5	27	17,00
FG 180/IN6	27	25,00
FG 180/IN7	27	28,50
FG 180/SP6	27	125,00
FG 180/SP9	27	216,00
FG 180/SP7IN	27	133,00
FG 180/S12	205	85,00
FG 180/S38	205	700,00
FG 180/S17	205	590,00
FG 180/S6	297	210,00
FG 181/A14	200	19,00
FG 181/A16	200	20,00
FG 181/A18	200	23,00
FG 181/A21	200	25,00
FG 181/B14	200	16,50
FG 181/B16	200	18,00
FG 181/B18	200	20,00
FG 181/B21	200	23,00
FG 181/C14	200	28,50
FG 181/RE1	200	40,00
FG 181/RE2	200	40,00
FG 181RE/S2	200	79,50
FG 181T/A14	200	54,00
FG 181T/A16	200	55,00
FG 181T/A21	200	67,00
FG 181/S3	200	175,50
FG 181/S17	201	115,00
FG 181/S130	201	280,00
FG 181/S115	201	380,00
FG 181/PM	218	152,50
FG 181/PM2	218	93,00
FG 182/ES1	159	48,50
FG 182/ES2	159	60,00
FG 182/ES3	159	62,00
FG 182/ES4	159	64,00
FG 182/ES5	159	98,00
FG 182/ES6	159	101,00
FG 182/ES7	159	122,00
FG 182/EG1	159	79,50
FG 182/EG2	159	122,00

CODICE	PAGINA	€/Pz
FG 182/S10	159	875,00
FG 182/S5B	159	475,00
FG 182/S14	160	238,00
FG 182/MI	160	80,00
FG 182/TS1	161	31,00
FG 182/TS2	161	43,00
FG 182/TS3	161	75,00
FG 182/S16	199	500,00
FG 182/S16-ES	199	66,00
FG 182/S16-PR	199	32,00
FG 182/S16-PU10	199	44,00
FG 182/S16-PR2	199	32,00
FG 182/S16-GU	199	4,50
FG 182/S4-5	199	5,50
FG 182/S16-PU7	199	50,00
FG 182/S16-PU9	199	50,00
FG 182/S4-1	199	55,00
FG 182/S16-IF14	199	10,00
FG 182/S16-MA14	199	9,00
FG 182/RG10	279	19,00
FG 182/RG24	279	26,00
FG 183/S5	200	108,50
FG 183/B8	200	31,00
FG 183/B9	200	31,00
FG 183/B10	200	31,00
FG 183/B12	200	31,00
FG 183/B14	200	31,00
FG 183/NOX	201	30,00
FG 183/B85	201	39,50
FG 183/B110	201	47,50
FG 183/RV1	279	21,00
FG 183/RA1	279	26,00
FG 183RA/S10	279	12,50
FG 183/CM	279	51,50
FG 183CM/S3	279	25,00
FG 183/CM19	279	8,50
FG 183/CM25	279	8,50
FG 183/CM38	279	8,50
FG 183/CK250	280	22,00
FG 183/CK450	280	33,00
FG 183/CK600	280	41,50
FG 183/CK-R	280	10,50
FG 184/B13	218	29,00
FG 184/B15	218	29,00
FG 184/B16	218	29,00
FG 184/B17	218	29,00
FG 184/B19	218	29,00
FG 184/FT1	218	70,00
FG 184/S5	218	155,00
FG 184/S6	218	95,00
FG 184/S24	265	463,50
FG 184/BP	265	216,50
FG 184/CP	265	77,50
FG 184P/S3	275	26,00
FG 184R/S3	275	46,50
FG 184/R1	275	21,00
FG 184/R2	275	23,00
FG 185/S27	203	115,50
FG 185/S190	213	154,50
FG 185P/S4	275	26,00
FG 185/A1	276	21,00
FG 185/A2	276	21,00
FG 185/A3	276	18,00
FG 185/A4	276	19,00
FG 185/A5	276	21,00
FG 185/A6	276	16,50
FG 185/A7	276	21,00

CODICE	PAGINA	€/Pz
FG 185/A8	276	19,00
FG 185/S5	277	98,00
FG 185B/S2	277	41,50
FG 185/RM	278	31,00
FG 185/CR	278	10,50
FG 186P/S4	209	24,00
FG 186/S11	275	118,50
FG 186/A1	277	22,00
FG 186/A2	277	22,00
FG 186/A3	277	18,50
FG 186/A4	277	17,00
FG 186/A5	277	25,00
FG 186/S5	277	98,00
FG 186P/S5	278	37,50
FG 186/AL1	278	25,00
FG 186/LP	278	36,50
FG 186/S3	278	10,00
FG 186/S3B	278	12,00
FG 186/S4	278	25,00
FG 186/AS	282	41,50
FG 187/GR	280	29,00
FG 187/GU	280	29,00
FG 187/GU2	280	26,00
FG 187/IM	280	41,50
FG 187/WT22.5	280	26,00
FG 187/W50	280	35,50
FG 187/IW50	280	31,00
FG 187/NY	280	62,00
FG 187/K25	281	43,50
FG 187/K10	281	24,00
FG 187/K30	281	72,50
FG 187/K40	281	196,00
FG 187/K130	281	288,50
FG 187K/S6	281	57,00
FG 187/S7	281	216,50
FG 187/S2	281	700,00
FG 187/PN	282	263,00
FG 187/TB	282	242,50
FG 188/1	201	14,50
FG 188/2	201	19,50
FG 188P/S2	275	41,50
FG 188/P1	275	19,00
FG 188P/S4	282	65,00
FG 189/S13	203	230,00
FG 189/PO1	278	21,00
FG 189/PO2	279	40,00
FG 190/EL1A	195	11,00
FG 190/EL1	195	11,00
FG 190/A25	195	42,00
FG 190/A27	195	42,00
FG 190/A29	195	42,00
FG 190/A30	195	42,00
FG 190/AD1	195	52,00
FG 190/AD2	195	34,00
FG 190/RI	195	56,00
FG 190/IP	195	48,00
FG 190/OP	195	45,00
FG 190/RE	196	235,00
FG 190/MI	196	85,00
FG 190/MI2	196	96,00
FG 190/S8	196	140,00
FG 190/EL	196	11,00
FG 190/A25	196	42,00
FG 190/A27	196	42,00
FG 190/A29	196	42,00
FG 190/A30	196	42,00
FG 190/S6B	197	165,00

CODICE	PAGINA	€/Pz
FG 190/S6-1	197	44,00
FG 190/S6-2	197	44,00
FG 190/S6-3	197	44,00
FG 190/S6-4	197	44,00
FG 190/S6-5	197	44,00
FG 190/S21	197	350,00
FG 190/S21-1	197	38,40
FG 190/S21-4	197	12,70
FG 190/S21-5	197	15,70
FG 190/S21-6	197	16,50
FG 190/S21-7	197	21,90
FG 190/S21-8	197	3,30
FG 190/S21-9	197	1,10
FG 190/S21-11	197	17,40
FG 190/S21-12	197	9,10
FG 190/S21-13	197	20,40
FG 190/RI	197	56,00
FG 190/S21-15	197	38,80
FG 190/SV2	201	420,00
FG 190/SV	202	130,00
FG 191/S22	195	620,00
FG 191/ES-SN	195	33,00
FG 191/ES-6	195	27,50
FG 191/ES-7	195	27,50
FG 191/ES-8	195	27,50
FG 191/ES-9	195	33,00
FG 191/ES-10	195	33,00
FG 191/ES-2	195	27,50
FG 191/ES-1	195	27,50
FG 191/ES-3	195	33,00
FG 191/ES-4	195	33,00
FG 191/ES-5	195	33,00
FG 191/ES-11	195	33,00
FG 191/ES-12	195	33,00
FG 191/ES-13	195	33,00
FG 191/ES-14	195	33,00
FG 191/MI	195	198,00
FG 191/S14	198	150,00
FG 191/S14-2	198	3,00
FG 191/S14-3	198	1,10
FG 191/S14-4	198	21,90
FG 191/S14-1	198	15,70
FG 191/S14-6	198	28,30
FG 191/S14-7	198	30,20
FG 191/S14-8	198	13,50
FG 191/S14-9	198	13,50
FG 191/S14-10	198	13,50
FG 192/BW4	222	188,00
FG 192/BW4-1	222	69,80
FG 192/BW4-2	222	58,20
FG 192/BW4-3	222	17,50
FG 192/BW4-4	222	32,00
FG 192/BW3	222	56,00
FG 192/BW4E	222	96,00
FG 192/BW16	223	250,00
FG 192/BW4B	223	350,00
FG 192/BW1	223	44,00
FG 192/BW2	223	57,00
FG 192/BW9B	223	480,00
FG 192/BW4-1	223	69,80
FG 192/BW9B-2	223	140,00
FG 192/BW9B-3	223	30,00
FG 192/BW9B-4	223	120,00
FG 192/BW4-4	223	32,00
FG 192/BW9B-6	223	5,00
FG 192/BW4-2	223	58,20
FG 192/BW4C	224	145,00

CODICE	PAGINA	€/Pz
FG 192/BW9C	224	65,00
FG 192/BW5	224	190,00
FG 192/BW5-1	224	56,70
FG 192/BW5-2	224	47,30
FG 192/BW5-3	224	9,00
FG 192/BW5-4	224	11,00
FG 192/BW5-5	224	11,00
FG 192/BW5-6	224	15,80
FG 192/BW15	224	900,00
FG 192/BW15A	224	35,00
FG 192/BW6	225	410,00
FG 192/BW6-1	225	159,40
FG 192/BW8-2	225	97,60
FG 192/MI10-4	225	32,50
FG 192/BW6-4	225	153,80
FG 192/BW6-5	225	195,80
FG 192/BW6-6	225	11,20
FG 192/BW8	225	430,00
FG 192/BW8-1	225	119,30
FG 192/BW8-2	225	97,60
FG 192/BW8-3	225	135,60
FG 192/BW8-4	225	10,80
FG 192/MI10-4	225	32,50
FG 192/BW8-6	225	13,60
FG 192/BW8-7	225	21,70
FG 192/BW8-8	225	16,30
FG 192/BW18	225	510,00
FG 192/BW7	226	358,00
FG 192/BW8-6	226	13,60
FG 192/BW7-2	226	141,00
FG 192/BW7-3	226	141,00
FG 192/BW7-4	226	55,10
FG 192/BW9	226	600,00
FG 192/BW9-1	226	297,50
FG 192/BW9-2	226	158,60
FG 192/BW9-3	226	35,30
FG 192/MI10-4	226	32,50
FG 192/BW8-6	226	13,60
FG 192/BW5-3	226	9,00
FG 192/BW8B	226	285,00
FG 192/BW8B-1	226	170,00
FG 192/BW8B-2	226	15,00
FG 192/MI10-4	226	32,50
FG 192/MI10-3	226	12,00
FG 192/BW8C	227	420,00
FG 192/BW8C-1	227	195,00
FG 192/BW8C-2	227	106,00
FG 192/MI10-4	227	32,50
FG 192/BW8C-4	227	16,00
FG 192/BW10	227	440,00
FG 192/BW11	227	680,00
FG 192/BW19	227	855,00
FG 192/AF5	227	120,00
FG 192/AF4	228	175,00
FG 192/AF4-1	228	19,00
FG 192/AF4-2	228	20,20
FG 192/AF4-3	228	59,30
FG 192/AF4-4	228	59,30
FG 192/AF4B	228	270,00
FG 192/AF2	228	65,00
FG 192/AF4C	228	100,00
FG 192/FT8	228	175,00
FG 192/FT8C	229	448,00
FG 192/FT1	229	40,00
FG 192/FT3	229	82,00
FG 192/FT4	229	88,00
FG 192/FT5	229	295,00

CODICE	PAGINA	€/Pz
FG 192/FT5-1	229	140,00
FG 192/FT5-2	229	44,00
FG 192/FT5-3	229	41,20
FG 192/FT5-4	229	9,20
FG 192/FT5A	230	20,00
FG 192/FT5B	230	260,00
FG 192/FT5B-1	230	70,50
FG 192/FT5B-2	230	94,90
FG 192/FT12-1	230	9,50
FG 192/FT12-3	230	29,00
FG 192/FT5B-5	230	33,90
FG 192/FT7	230	182,00
FG 192/FT7-1	230	17,80
FG 192/FT7-2	230	17,80
FG 192/FT7-3	230	5,10
FG 192/FT7-4	230	91,50
FG 192/FT7-5	230	10,20
FG 192/FT7-6	230	7,60
FG 192/FT12	231	320,00
FG 192/FT12-1	231	9,50
FG 192/FT12-2	231	26,00
FG 192/FT12-3	231	29,00
FG 192/FT12-4	231	125,00
FG 192/FT12-5	231	15,00
FG 192/FT12-6	231	99,00
FG 192/FT6	231	250,00
FG 192/FT6-1	231	35,00
FG 192/FT6-2	231	81,40
FG 192/FT6-3	231	65,00
FG 192/FT6-4	231	42,00
FG 192/FT6-5	231	11,50
FG 192/FT2	231	58,00
FG 192/FT6A	231	130,00
FG 192/FT6B	232	165,00
FG 192/FT6B-1	232	42,50
FG 192/FT6B-2	232	55,00
FG 192/FT17-4	232	42,00
FG 192/FT6B-4	232	6,50
FG 192/FT5C	232	135,00
FG 192/FT5C-1	232	36,00
FG 192/FT5C-2	232	12,00
FG 192/FT5C-3	232	45,00
FG 192/FT17-12	232	22,50
FG 192/JTD	232	90,00
FG 192/FT6C	233	132,00
FG 192/FT6C-1	233	75,00
FG 192/FT6C-2	233	19,50
FG 192/FT6C-3	233	13,00
FG 192/FT6D	233	82,00
FG 192/FT10	233	150,00
FG 192/FT10-1	233	82,00
FG 192/FT12-1	233	9,50
FG 192/FT10-3	233	27,00
FG 192/FT16	234	280,00
FG 192/FT10C	234	370,00
FG 192/FT10D	234	370,00
FG 192/FT17	234	680,00
FG 192/FT17-1	234	95,00
FG 192/FT17-2	234	56,00
FG 192/FT17-3	234	32,00
FG 192/FT17-4	234	42,00
FG 192/FT17-5	234	29,50
FG 192/FT17-6	234	36,50
FG 192/FT17-7	234	67,00
FG 192/FT17-8	234	67,00
FG 192/FT17-9	234	12,50
FG 192/FT17-10	234	18,00

INDICE ANALITICO

CODICE	PAGINA	€/Pz
FG 192/FT17-11	234	12,50
FG 192/FT17-12	234	22,50
FG 192/FT17-13	234	29,50
FG 192/FT17-14	234	77,00
FG 192/FT17-15	234	10,00
FG 192/FT17-16	234	40,00
FG 192/FO16	235	660,00
FG 192/FO16C	235	298,00
FG 192/FO2	235	205,00
FG 192/FO16A	235	1.250,00
FG 192/FO16B	235	210,00
FG 192/FO6	235	105,00
FG 192/FO7C	236	130,00
FG 192/FO4A	236	85,00
FG 192/FO4	236	190,00
FG 192/VW7-5	236	7,10
FG 192/FO4-2	236	16,50
FG 192/FO4-3	236	78,00
FG 192/FO4-4	236	12,00
FG 192/FO4-5	236	8,50
FG 192/FO24-4	236	12,00
FG 192/FO4-7	236	22,00
FG 192/FO15	236	570,00
FG 192/FO15A	236	260,00
FG 192/FO7	237	98,00
FG 192/PS15-8	237	15,00
FG 192/FO24-20	237	12,50
FG 192/FO7-3	237	52,50
FG 192/FO7B	237	110,00
FG 192/FO7E	237	35,00
FG 192/FO24	238	290,00
FG 192/FO24-1	238	41,90
FG 192/FO24-2	238	9,70
FG 192/FO24-3	238	12,90
FG 192/FO24-4	238	12,00
FG 192/FO24-5	238	13,00
FG 192/FO24-6	238	17,50
FG 192/FO24-7	238	8,30
FG 192/FO24-8	238	12,90
FG 192/FO24-9	238	12,50
FG 192/FO24-10	238	6,20
FG 192/FO24-11	238	6,20
FG 192/FO24-12	238	8,10
FG 192/FO24-13	238	8,10
FG 192/FO24-14	238	14,20
FG 192/FO24-15	238	3,20
FG 192/FO24-16	238	6,40
FG 192/FO24-17	238	29,00
FG 192/FO24-18	238	22,50
FG 192/FO24-19	238	19,30
FG 192/FO24-20	238	12,50
FG 192/FO24-21	238	12,00
FG 192/FO24-22	238	15,00
FG 192/FO24-23	238	15,00
FG 192/FO3	238	55,00
FG 192/FO8	238	95,00
FG 192/FO24-4	238	12,00
FG 192/FO24-5	238	13,00
FG 192/FO24-7	238	8,30
FG 192/FO24-6	238	17,50
FG 192/FO24-9	238	12,50
FG 192/FO24-10	238	6,20
FG 192/FO24-11	238	6,20
FG 192/FO24-20	238	12,50
FG 192/FO11	239	255,00
FG 192/FO11-1	239	77,10
FG 192/FO11-2	239	3,00

CODICE	PAGINA	€/Pz
FG 192/FO11-3	239	83,10
FG 192/FO11-4	239	23,70
FG 192/FO11-5	239	17,80
FG 192/FO11-6	239	17,80
FG 192/FO11-7	239	23,70
FG 192/LRF	239	220,00
FG 192/LR11	239	820,00
FG 192/LR13	239	465,00
FG 192/LR9	240	370,00
FG 192/LR8	240	315,00
FG 192/LR6	240	275,00
FG 192/LR2	240	55,00
FG 192/MI6	240	210,00
FG 192/MI6-1	240	70,20
FG 192/MI6-2	240	39,00
FG 192/MI6-3	240	101,40
FG 192/MI10B	241	320,00
FG 192/MI10B-1	241	185,00
FG 192/MI10B-2	241	110,00
FG 192/MI10B-3	241	8,50
FG 192/MI10B-4	241	30,00
FG 192/MI10-4	241	32,50
FG 192/MI10	241	365,00
FG 192/MI10-1	241	98,00
FG 192/MI10-2	241	110,00
FG 192/MI10-3	241	12,00
FG 192/MI10-4	241	32,50
FG 192/MI10-5	241	3,10
FG 192/MI10-6	241	95,00
FG 192/MI9	241	82,00
FG 192/MB3C	241	260,00
FG 192/MB3	242	248,00
FG 192/MB3A	242	210,00
FG 192/MB4	242	300,00
FG 192/MB7	242	280,00
FG 192/MB24	242	820,00
FG 192/MB24-1	242	230,00
FG 192/MB24-2	242	150,00
FG 192/MB24-3	242	250,00
FG 192/MB24-4	242	60,00
FG 192/MB24-5	242	8,00
FG 192/MB24-6	242	20,00
FG 192/MB5	243	360,00
FG 192/MB5-1	243	19,00
FG 192/MB5-2	243	129,00
FG 192/MB5-3	243	118,00
FG 192/MB5-4	243	38,00
FG 192/MB5-5	243	29,00
FG 192/MB10	243	160,00
FG 192/CH3	243	145,00
FG 192/MB6	243	180,00
FG 192/MB6-1	243	56,00
FG 192/MB6-2	243	73,00
FG 192/MB6-3	243	35,00
FG 192/CH8	244	220,00
FG 192/CH8-1	244	34,40
FG 192/CH8-2	244	24,60
FG 192/CH8-3	244	29,50
FG 192/CH8-4	244	27,00
FG 192/CH8-5	244	27,00
FG 192/VW1D	244	32,00
FG 192/CH8-7	244	14,70
FG 192/CH8-8	244	29,50
FG 192/IE9	244	295,00
FG 192/IE9-1	244	120,00
FG 192/IE9-2	244	140,00
FG 192/IE9-3	244	6,00

CODICE	PAGINA	€/Pz
FG 192/IE9-4	244	65,00
FG 192/OP5	244	120,00
FG 192/OP5-1	244	67,00
FG 192/OP5-2	244	6,50
FG 192/OP5-3	244	6,50
FG 192/OP5-4	244	21,00
FG 192/OP5-5	244	15,00
FG 192/OP7B	245	230,00
FG 192/OP7	245	325,00
FG 192/OP2	245	55,00
FG 192/OP3	245	55,00
FG 192/OP3B	245	245,00
FG 192/OP3A	246	110,00
FG 192/OP4	246	105,00
FG 192/OP1	246	16,00
FG 192/OP4D	246	565,00
FG 192/OP4B	246	360,00
FG 192/OP6	246	110,00
FG 192/OP8	247	180,00
FG 192/OP15	247	520,00
FG 192/OP10	247	210,00
FG 192/OP9	247	360,00
FG 192/PS13	248	205,00
FG 192/PS13-1	248	20,00
FG 192/PS13-2	248	20,00
FG 192/PS15-6	248	14,29
FG 192/PS15-5	248	14,29
FG 192/PS13-5	248	51,50
FG 192/PS13-6	248	25,80
FG 192/FO24-22	248	15,00
FG 192/PS15-7	248	15,00
FG 192/FO24-23	248	15,00
FG 192/PS13-10	248	32,20
FG 192/PS13-11	248	4,80
FG 192/PS13-12	248	3,20
FG 192/PS15	248	280,00
FG 192/PS15-1	248	9,10
FG 192/PS15-2	248	10,37
FG 192/PS15-3	248	10,37
FG 192/PS15-4	248	26,03
FG 192/PS15-5	248	14,29
FG 192/PS15-6	248	14,29
FG 192/PS15-7	248	15,00
FG 192/PS15-8	248	15,00
FG 192/PS15-9	248	1,27
FG 192/PS15-10	248	9,10
FG 192/PS15-11	248	5,19
FG 192/PS15-12	248	9,10
FG 192/PS13-11	248	4,80
FG 192/PS15-14	248	7,83
FG 192/PS15-15	248	98,83
FG 192/PS15-16	248	6,46
FG 192/PS15-17	248	5,19
FG 192/PS15-18	248	7,80
FG 192/PS15-19	248	15,00
FG 192/PS7	249	225,00
FG 192/PS7-1	249	45,00
FG 192/PS7-2	249	53,00
FG 192/PS7-3	249	5,10
FG 192/PS7-4	249	12,70
FG 192/PS7-5	249	6,40
FG 192/PS7-6	249	12,70
FG 192/PS15-11	249	5,19
FG 192/PS7-8	249	50,00
FG 192/PS4	249	55,00
FG 192/PS5	249	280,00
FG 192/PS2	249	225,00

CODICE	PAGINA	€/Pz
FG 192/PSA	250	35,00
FG 192/PS7B	250	65,00
FG 192/RE5	250	195,00
FG 192/RE3-1	250	71,00
FG 192/RE5-2	250	56,90
FG 192/RE3-3	250	15,00
FG 192/RE3-2	250	9,70
FG 192/RE5-5	250	10,70
FG 192/RE3	250	115,00
FG 192/RE3-1	250	71,00
FG 192/RE3-2	250	9,70
FG 192/RE3-3	250	15,00
FG 192/RE4	251	245,00
FG 192/RE4-1	251	90,00
FG 192/RE4-2	251	18,00
FG 192/RE6-5	251	47,30
FG 192/RE6-6	251	57,80
FG 192/RE7	251	98,00
FG 192/RE13A	251	135,00
FG 192/RE13	251	315,00
FG 192/RE13-1	251	65,00
FG 192/RE13-2	251	42,50
FG 192/RE13-3	251	115,00
FG 192/RE3-2	251	9,70
FG 192/RE13-5	251	30,00
FG 192/RE13-6	251	12,00
FG 192/RE13-7	251	9,00
FG 192/RE13-8	251	15,00
FG 192/RE6	252	240,00
FG 192/FT6B-4	252	6,50
FG 192/RE6-2	252	13,10
FG 192/RE6-3	252	52,50
FG 192/RE6-4	252	18,40
FG 192/RE6-5	252	47,30
FG 192/RE6-6	252	57,80
FG 192/RE6-7	252	2,60
FG 192/VW1	252	58,00
FG 192/VW1B	252	28,00
FG 192/VW1C	252	30,00
FG 192/VW1D	252	32,00
FG 192/VW1E	253	48,00
FG 192/VW1F	253	98,00
FG 192/VW5B	253	275,00
FG 192/VW5B-1	253	11,20
FG 192/VW5B-2	253	14,00
FG 192/VW5B-3	253	9,80
FG 192/VW5B-4	253	291,00
FG 192/VW4B	253	260,00
FG 192/VW4B-1	253	92,00
FG 192/VW4B-2	253	15,00
FG 192/VW4B-3	253	118,00
FG 192/VW4B-4	253	18,00
FG 192/VW2	254	75,00
FG 192/VW3B	254	275,00
FG 192/VW4	254	148,00
FG 192/VW4-1	254	41,20
FG 192/VW4-2	254	45,80
FG 192/VW4-3	254	36,60
FG 192/VW4C	254	315,00
FG 192/VW4C-1	254	76,00
FG 192/VW4C-2	254	86,00
FG 192/VW4C-3	254	11,90
FG 192/VW4C-4	254	14,50
FG 192/VW4B-4	254	18,00
FG 192/VW4B-1	254	92,00
FG 192/VW7-4	254	10,00
FG 192/VW8	255	340,00

CODICE	PAGINA	€/Pz
FG 192/VW8-1	255	37,80
FG 192/VW8-2	255	65,00
FG 192/VW8-3	255	65,00
FG 192/VW8-4	255	16,00
FG 192/VW8-5	255	4,30
FG 192/VW8-6	255	5,40
FG 192/PM	255	82,00
FG 192/CO	255	102,00
FG 192/VW8C	255	330,00
FG 192/VW8D	255	480,00
FG 192/VW8B	255	120,00
FG 192/VW8E	255	110,00
FG 192/VW7C	256	205,00
FG 192/VW5	256	40,00
FG 192/VW7D	256	360,00
FG 192/VW7D-1	256	50,00
FG 192/VW7D-2	256	13,90
FG 192/VW7D-3	256	85,00
FG 192/VW7-5	256	7,10
FG 192/VW7D-5	256	195,00
FG 192/VW7D-6	256	11,50
FG 192/VW7	257	150,00
FG 192/VW14-2	257	39,00
FG 192/VW7-2	257	35,60
FG 192/VW7-3	257	14,20
FG 192/VW7-4	257	10,00
FG 192/VW7-5	257	7,10
FG 192/FO24-15	257	3,20
FG 192/VW10B	257	380,00
FG 192/VW10B-1	257	145,00
FG 192/VW10-7	257	70,00
FG 192/VW7-4	257	10,00
FG 192/VW10-6	257	15,00
FG 192/VW10-5	257	15,00
FG 192/VW10B-6	257	72,50
FG 192/FO24-14	257	14,20
FG 192/VW14	258	320,00
FG 192/VW14-1	258	31,20
FG 192/VW14-2	258	39,00
FG 192/VW14-3	258	46,80
FG 192/FO24-14	258	14,20
FG 192/FO24-15	258	3,20
FG 192/VW14-6	258	11,70
FG 192/VW14-7	258	19,50
FG 192/VW14-8	258	15,60
FG 192/VW14-9	258	7,80
FG 192/VW14-10	258	23,40
FG 192/FO24-13	258	8,10
FG 192/VW14-12	258	31,20
FG 192/VW10	258	320,00
FG 192/FO24-14	258	14,20
FG 192/VW10-2	258	38,00
FG 192/VW10-3	258	27,00
FG 192/VW7-4	258	10,00
FG 192/VW10-5	258	15,00
FG 192/VW10-6	258	15,00
FG 192/VW10-7	258	70,00
FG 192/VW10-8	258	82,00
FG 192/VW10-9	258	19,00
FG 192/VW10-10	258	15,00
FG 192/VW11	259	1.660,00
FG 192/VW11-1	259	270,00
FG 192/VW11-2	259	91,00
FG 192/VW11-3	259	100,00
FG 192/VW11-4	259	930,00
FG 192/VW11-5	259	36,00
FG 192/VW11-6	259	35,00

CODICE	PAGINA	€/Pz
FG 192/VW11-7	259	65,00
FG 192/VW11-8	259	75,00
FG 192/VW11-9	259	75,00
FG 192/VW7B	259	192,00
FG 192/FO24-13	259	8,10
FG 192/FO24-12	259	8,10
FG 192/FO24-8	259	12,90
FG 192/VW7B-4	259	94,90
FG 192/VW7B-5	259	57,60
FG 192/VW7B-6	259	16,90
FG 192/VW9	259	165,00
FG 192/VW9-1	259	55,00
FG 192/VW9-2	259	2,00
FG 192/VW9-3	259	36,00
FG 192/VW9-4	259	20,00
FG 192/VW9-5	259	13,00
FG 192/VW14-9	259	7,80
FG 192/VW6	260	530,00
FG 192/VW6-1	260	22,40
FG 192/VW6-2	260	100,70
FG 192/VW6-3	260	22,40
FG 192/VW6-4	260	209,70
FG 192/VW6-5	260	41,90
FG 192/VW6-6	260	106,30
FG 192/VW6B	260	195,00
FG 192/VW6B-1	260	65,00
FG 192/VW6B-2	260	107,00
FG 192/VW6B-3	260	48,00
FG 192/VO1	261	102,00
FG 192/VO3	261	245,00
FG 192/VW5C	261	280,00
FG 192/VW12	261	330,00
FG 192/VW12-1	261	17,80
FG 192/VW12-2	261	21,40
FG 192/VW12-3	261	14,20
FG 192/VW12-4	261	60,50
FG 192/VW12-5	261	71,20
FG 192/VW12-6	261	71,20
FG 192/VW12-7	261	21,40
FG 192/VW12-8	261	26,70
FG 192/VW14-8	261	15,60
FG 192/FO24-14	261	14,20
FG 192/VW12A	262	70,00
FG 192/PR6	262	130,00
FG 192/PR4	262	230,00
FG 192/PR5	262	360,00
FG 192/PR8	262	850,00
FG 192/HI7	262	195,00
FG 192/HI7B	263	90,00
FG 192/HI1	263	98,00
FG 192/HI2	263	132,00
FG 192/HO5	263	95,00
FG 192/DW2	263	105,00
FG 192/HI5	263	60,00
FG 192/TY45	264	610,00
FG 192/TY45-1	264	2,00
FG 192/TY45-2	264	64,00
FG 192/TY45-3	264	42,50
FG 192/TY45-4	264	12,50
FG 192/TY45-5	264	15,00
FG 192/TY45-6	264	20,00
FG 192/TY45-7	264	12,50
FG 192/TY45-8	264	17,50
FG 192/TY45-9	264	22,50
FG 192/TY45-10	264	10,00
FG 192/TY45-11	264	20,00
FG 192/TY45-12	264	15,00

CODICE	PAGINA	€/Pz
FG 192/TY45-13	264	25,00
FG 192/TY45-14	264	9,00
FG 192/TY45-15	264	9,00
FG 192/TY45-16	264	9,00
FG 192/TY45-17	264	9,00
FG 192/TY45-18	264	4,00
FG 192/TY45-19	264	106,00
FG 192/TY45-20	264	2,00
FG 192/TY45-21	264	106,00
FG 192/TY45-22	264	6,50
FG 192/TY45-23	264	4,50
FG 192/TY45-24	264	2,00
FG 192/TY45-25	264	6,50
FG 192/TY45-26	264	55,00
FG 192/TY15	264	175,00
FG 192/CO	265	102,00
FG 192/PM	265	82,00
FG 192/CE	265	78,00
FG 193/M5	201	0,60
FG 193/M6	201	0,70
FG 193/M8	201	0,80
FG 193/M10	201	0,90
FG 193/M12	201	1,20
FG 193/M14	201	1,50
FG 193/R1	266	175,00
FG 193/R2	266	175,00
FG 193/R3	266	42,00
FG 193/R4	266	46,00
FG 193/R5	266	18,00
FG 193/R6	266	35,00
FG 193/R7	267	24,00
FG 193/R8	267	35,00
FG 193/R9	267	30,00
FG 193/R10	267	35,00
FG 193/R11	267	24,00
FG 193/R12	267	95,00
FG 193/R13	267	46,00
FG 193/R13B	267	46,00
FG 193/R14	267	52,00
FG 193/R15	267	30,00
FG 193/R16	268	88,00
FG 193/R17	268	30,00
FG 193/R18	268	86,00
FG 193/R19	268	95,00
FG 193/R20	268	125,00
FG 193/R21	268	116,00
FG 193/R22	268	58,00
FG 193/R23	268	46,00
FG 193/R24	268	28,00
FG 193/R25	268	105,00
FG 193/R26	269	170,00
FG 193/R27	269	135,00
FG 193/R28	269	70,00
FG 193/R30	269	128,00
FG 193/R31	269	82,00
FG 193/R32	269	128,00
FG 193/R42	269	105,00
FG 193/R44	269	105,00
FG 193/R45	269	105,00
FG 193/R46	269	105,00
FG 193/R47	269	105,00
FG 193/R48	269	105,00
FG 193/R34	269	93,00
FG 193/R35	269	58,00
FG 193/R36	270	105,00
FG 193/R37	270	65,00
FG 193/R29	270	46,00

CODICE	PAGINA	€/Pz
FG 193/R38	270	65,00
FG 193/R39	270	65,00
FG 193/R33	270	46,00
FG 193/R40	270	65,00
FG 193/R41	270	70,00
FG 193/S19	270	1.280,00
FG 193/S10	271	1.050,00
FG 193/AT1	271	1.350,00
FG 193/AT1-8	271	600,00
FG 193/AT2	271	750,00
FG 193/AT2-9	271	250,00
FG 193/AT3	271	980,00
FG 193/UN	271	1.100,00
FG 193/DCT	272	160,00
FG 193/DS1	272	35,00
FG 193/DS2	272	35,00
FG 193/ATJ	272	45,00
FG 193/MB	272	65,00
FG 193/S4	272	590,00
FG 193DSG/S9	272	1.050,00
FG 193DSG/S6	272	695,00
FG 194/TS	272	32,00
FG 195/S4B	203	90,00
FG 195/VW	204	22,50
FG 195/U	216	11,00
FG 196/A12	216	27,00
FG 197/B1	202	30,00
FG 197/B2	202	32,00
FG 197/B3	202	37,00
FG 197/A3	202	34,00
FG 197/A4	202	40,00
FG 197/A6	202	58,00
FG 197/A36	207	40,00
FG 197/B36	207	40,00
FG 197/IV1	284	240,00
FG 197/IV2	284	242,00
FG 197/MB1	288	90,00
FG 197/MB2	288	120,00
FG 197/MA1	289	95,00
FG 197/VO1	291	95,00
FG 197/VO2	291	77,00
FG 197/VO3	291	62,00
FG 197/VO4	292	73,00
FG 197/SC1	294	66,00
FG 197/DA1	294	88,00
FG 197/DA2	294	68,00
FG 197/BP	297	330,00
FG 197/F1	297	50,00
FG 197/F2	297	28,00
FG 198/S11	207	138,00
FG 198/B7	207	17,50
FG 198/B9	207	17,50
FG 198/DG	207	33,00
FG 198/A30	207	32,00
FG 198/A32	207	32,00
FG 198/A34	207	32,00
FG 198/A35	207	34,00
FG 198/A36	207	38,00
FG 198/DU55	207	85,00
FG 198/DU46	207	70,00
FG 198/PE	209	60,00
FG 198/A1	210	38,00
FG 198/B1	210	130,00
FG 198/A2	210	38,00
FG 198/DF	213	360,00
FG 199/PF	206	225,00
FG 199/SF	206	60,00

CODICE	PAGINA	€/Pz
FG 199/PFP	206	22,00
FG 199/PM1	206	37,00
FG 199/PM2	206	42,00
FG 199/PM3	206	112,00
FG 199/FM	206	32,00
FG 199/A	206	52,00
FG 201/S7	194	340,00
FG 201/CR	196	250,00
FG 202/PV	194	230,00
FG 202	307	55,00
FG 203/S7	194	166,00
FG 203/S20	194	370,00
FG 203/BW1	194	36,50
FG 203/FO1	194	36,50
FG 203/FO2	194	36,50
FG 203/OP1	194	36,50
FG 203/TO1	194	36,50
FG 203/A	194	23,00
FG 203	307	25,00
FG 204	307	31,50
FG 205	307	85,00
FG 206	308	55,00
FG 207	309	65,00
FG 207/B	309	98,00
FG 208	309	230,00
FG 209	309	265,00
FG 210/A	310	90,00
FG 210/B	310	85,00
FG 210/C	311	165,00
FG 211	310	110,00
FG 212	310	78,00
FG 213/L480	308	65,00
FG 213/SM	448	750,00
FG 213/SM1	448	590,00
FG 213/SU	448	630,00
FG 213/LT	449	310,00
FG 214/L600	308	85,00
FG 215	219	950,00
FG 215/S40	219	1.550,00
FG 215/S39	220	600,00
FG 215/CA1	220	26,00
FG 215/CA2	220	27,00
FG 215/CA3	220	27,00
FG 215/CA4	220	30,00
FG 215/CA5	220	30,00
FG 215/CA6	220	30,00
FG 215/CA7	220	30,00
FG 215/CA8	220	30,00
FG 215/CA9	220	30,00
FG 215/CA10	220	32,00
FG 215/CA11	220	32,00
FG 215/CA12	220	33,00
FG 215/CA13	220	34,00
FG 215/CA14	220	35,00
FG 215/CA15	220	35,00
FG 215/CA16	220	40,00
FG 215/CA17	220	55,00
FG 215/CA19	220	56,00
FG 215/CA20	220	40,00
FG 215/CA21	220	55,00
FG 215/CA22	220	52,00
FG 215/AD90	220	33,00
FG 215/TU	220	105,00
FG 215/FI23	220	42,00
FG 215/FI24	220	48,00
FG 215/FI25	220	54,00
FG 215/FI26	220	55,00

CODICE	PAGINA	€/Pz
FG 215MP/S9	220	195,00
FG 215TU/BE	220	46,00
FG 215BE/M10	220	11,00
FG 215BE/M12	220	11,00
FG 215BE/M14	220	11,00
FG 215BE/M14F	220	22,00
FG 215BE/M16	220	11,00
FG 215BE/PR	220	70,00
FG 217	311	250,00
FG 219/S	221	3.350,00
FG 220/BT	221	420,00
FG 221	311	340,00
FG 222/A	308	120,00
FG 222/B	311	350,00
FG 224/L5200	312	250,00
FG 224/SU	312	100,00
FG 225/SK1.5	306	300,00
FG 225/SK2.5	306	370,00
FG 234	313	105,00
FG 235	313	135,00
FG 236	313	335,00
FG 236/SU	313	100,00
FG 260	303	80,00
FG 260/GP	303	195,00
FG 260/RP	304	62,50
FG 260PR/S1	304	23,00
FG 260PR/S2	304	7,50
FG 260PR/S3	304	7,50
FG 260PR/S4	304	9,00
FG 261	303	135,00
FGA 290	173	192,00
FGA 290/KIT	173	20,00
FGA 291	174	170,00
FGA 291/KIT	174	30,00
FGA 292/B	174	215,00
FGA 292B/KIT	174	30,00
FGA 302	171	240,00
FGA 302/KIT	171	30,00
FGA 302/S4	171	295,00
FGA 302/S10	171	340,00
FGA 304	174	245,00
FGA 304/KIT	174	32,00
FGA 307	170	250,00
FGA 307/KIT	170	30,00
FGA 307/AN	175	340,00
FGA 307AN/KIT	175	30,00
FGA 309	170	300,00
FGA 309/KIT	170	45,00
FGA 309/S4	170	385,00
FGA 309/S10	170	395,00
FGA 312	171	380,00
FGA 312/KIT	171	45,00
FGA 316	172	760,00
FGA 316/L	172	830,00
FGA 316/KIT	172	100,00
FGA 319	172	1.150,00
FGA 319/L	172	1.250,00
FGA 319/KIT	172	100,00
FGA 321	173	1.050,00
FGA 321/B	173	1.100,00
FGA 321B/KIT	173	220,00
FGA 321/C	173	1.220,00
FGA 322	175	140,00
FGA 322/R2	175	33,00
FGA 322/KIT	175	28,00
FGA 330	175	295,00
FGA 330/KIT	175	30,00

CODICE	PAGINA	€/Pz
FGA 330/24T	175	47,00
FGA 330/32T	175	47,00
FGA 332/AN	176	180,00
FGA 332AN/KIT	176	28,00
FGA 332	176	145,00
FGA 332/KIT	176	28,00
FGA 333/AC	176	210,00
FGA 333	176	185,00
FGA 333/KIT	176	28,00
FGA 334	179	145,00
FGA 334/KIT	179	35,00
FGA 334/AN115	179	185,00
FGA 334/AN	179	185,00
FGA 334AN/KIT	179	35,00
FGA 334/L	180	185,00
FGA 334L/KIT	180	35,00
FGA 335	177	210,00
FGA 335/KIT	177	22,00
FGA 336	178	600,00
FGA 336/KIT	178	35,00
FGA 337	180	125,00
FGA 337/R1	180	16,00
FGA 337/KIT	180	28,00
FGA 338/MO1	148	6,00
FGA 338/MO2	148	6,00
FGA 338/MO3	148	6,00
FGA 338/MO4	148	6,00
FGA 338/MO5	148	6,00
FGA 338/MO6	148	6,00
FGA 338/MO7	148	6,00
FGA 338/MO10	148	6,00
FGA 338/MO8	148	6,00
FGA 338/MO9	148	6,00
FGA 338	178	125,00
FGA 338/KIT	178	28,00
FGA 338/B	178	160,00
FGA 338B/KIT	178	35,00
FGA 338/AN	178	170,00
FGA 338AN/KIT	178	28,00
FGA 338/L	179	165,00
FGA 338L/KIT	179	28,00
FGA 339/B	177	190,00
FGA 339/B-G60	177	9,00
FGA 339/B-G80	177	10,00
FGA 339/B-G120	177	12,00
FGA 339B/KIT	177	28,00
FGA 339	177	355,00
FGA 339/KIT	177	40,00
FGA 340	180	295,00
FGA 340/B	180	295,00
FGA 340/KIT	180	30,00
FGA 341	181	650,00
FGA 341/KIT	181	20,00
FGA 341/R1	181	33,00
FGA 341/R2	181	25,00
FGA 341/R3	181	22,00
FGA 341/R4	181	25,00
FGA 341/R5	181	29,00
FGA 341/R6	181	30,00
FGA 342/B	181	285,00
FGA 342	181	220,00
FGA 342/R120	181	22,00
FGA 342/R180	181	22,00
FGA 342/R320	181	22,00
FGA 342/R1000	181	27,00
FGA 342/R1500	181	27,00
FGA 342/RT120	181	55,00

CODICE	PAGINA	€/Pz
FGA 342/RT180	181	55,00
FGA 342/RT320	181	55,00
FGA 342/RT1000	181	55,00
FGA 342/RT1500	181	55,00
FGA 342/T120	181	60,00
FGA 342/T180	181	60,00
FGA 342/T320	181	60,00
FGA 342/T1000	181	72,00
FGA 342/T1500	181	72,00
FGA 342/KIT	181	20,00
FGA 343/N10	182	220,00
FGA 343/N20	182	285,00
FGA 345	182	320,00
FGA 345/KIT	182	20,00
FGA 345/M	182	10,50
FGA 345/SC	182	110,00
FGA 345/S1	182	12,00
FGA 345/S2	182	12,00
FGA 345/S3	182	18,00
FGA 345/S4	182	13,50
FGA 345/S5	182	9,50
FGA 346/B	180	220,00
FGA 376/1	184	6,50
FGA 376/2	184	6,50
FGA 377/1	184	25,50
FGA 377/2	184	21,00
FGA 377/3	184	25,50
FGA 378/1	185	10,00
FGA 378/2	185	10,00
FGA 379/1	184	33,00
FGA 379/2	185	31,00
FGA 379/3	185	33,00
FGA 380	183	76,00
FGA 380/1	184	4,50
FGA 380/2	184	3,50
FGA 380/3	184	3,50
FGA 380/4	184	4,50
FGA 380/5	184	3,50
FGA 380/6	184	3,50
FGA 380/1N	184	4,50
FGA 380/2N	184	3,50
FGA 380/3N	184	3,50
FGA 380/4N	184	4,50
FGA 380/5N	184	3,50
FGA 380/6N	184	3,50
FGA 380/SN	185	20,00
FGA 381/1	183	11,50
FGA 381/2	183	11,50
FGA 381/3	183	11,50
FGA 381/4	183	12,00
FGA 381/5	183	12,00
FGA 381/6	184	13,00
FGA 381/7	184	13,00
FGA 381/1N	184	10,50
FGA 381/2N	184	10,50
FGA 381/3N	184	11,00
FGA 381/4N	184	11,50
FGA 381/5N	184	11,50
FGA 382/B10	183	68,00
FGA 382/B15	183	80,00
FGA 382/B20	183	90,00
FGA 383	183	85,00
FGA 383/2	183	88,00
FGA 383/3	183	120,00
FGA 383/AR15	185	270,00
FGA 384/R1	183	10,00
FGA 384/R2	183	11,00

CODICE	PAGINA	€/Pz
FGA 384/B15	183	100,00
FGA 385	183	135,00
FGA 385/AR15	185	360,00
FGA 386	183	135,00
FGA 387	183	135,00
FGA 388/OL	185	18,00
FGA 390	175	150,00
FGA 416	183	20,00
FGA 419	183	21,00
FG 490/C500	300	52,00
FG 490/C800	300	65,00
FG 490/C1000	300	65,00
FG 490/TE	300	3,00
FG 490/PT	300	15,00
FG 491/AD1	193	35,00
FG 491/AD2	193	36,00
FG 491/200	193	38,00
FG 491/1500	193	85,00
FG 491/AD550	193	125,00
FG 491/DF1500	193	135,00
FG 491	300	21,50
FG 493/N	301	38,50
FG 493/AL	301	45,00
FG 493/AL2	301	46,00
FG 493/AL3	301	55,00
FG 494/S12	301	55,00
FG 494/A180	301	175,00
FG 495/FA1	300	10,00
FG 495/FA2	300	10,50
FG 495/FA3	300	11,50
FG 496/FP1	300	10,50
FG 496/FP2	300	11,00
FG 496/FP3	300	11,50
FG 497/OP1	300	6,30
FG 497/OP2	300	7,40
FG 497/OP3	300	7,60
FG 497/SP1	300	8,20
FG 497/SP2	300	9,00
FG 497	301	11,60
FG 500/FO135-15	283	84,00
FG 500/A90	283	148,00
FG 500/A98	283	190,50
FG 500/B105	283	309,00
FG 500/B110	283	264,00
FG 500/B115	283	266,00
FG 500/IV32.3	284	37,50
FG 500/IV72	284	98,00
FG 500/IV80	284	118,50
FG 500/IV85	284	122,50
FG 500/IV90	284	125,00
FG 500/IV95	284	142,00
FG 500/IV100	284	144,50
FG 500/IV105	284	159,00
FG 500/IV110	284	172,50
FG 500/IV115	284	185,50
FG 500/IV120	284	196,50
FG 500/IV-PO	284	156,00
FG 510/FO2	284	71,00
FG 510/WB	285	101,50
FG 520/GA1	285	257,00
FG 520/GA2	285	235,50
FG 520/GA3	285	70,50
FG 520/GA4	285	65,50
FG 520/GA5	285	208,50
FG 520/GA6	285	213,50
FG 522/C105	286	216,50
FG 522/B95	286	277,00

CODICE	PAGINA	€/Pz
FG 522/C101.5	286	216,50
FG 522/C91.5	286	202,50
FG 522/C80	286	171,50
FG 522/A95	286	218,50
FG 522/TU-DX	286	190,50
FG 522/TU-SX	286	204,50
FG 522/GA7	287	270,00
FG 522/A89	287	153,00
FG 522/B68	287	103,50
FG 524/MB-R56	287	100,50
FG 524/MB-R60	287	104,00
FG 524/MB-R62	287	103,50
FG 526/MB46	285	47,00
FG 527/PO-MB	287	831,00
FG 528	128	415,00
FG 528/RV1	287	23,00
FG 530/FO94	288	70,50
FG 531	128	215,00
FG 531/GA1	288	248,50
FG 531/GA2	288	330,00
FG 531/GA3	288	150,00
FG 531/GA4	288	119,00
FG 531/GA5	288	134,50
FG 531/GA6	289	115,50
FG 532/MA-1	289	343,00
FG 532/MA-2	289	250,00
FG 532/MA-3	289	363,00
FG 533/2	128	240,00
FG 534/GA1	289	92,50
FG 536/1	128	240,00
FG 536/2	128	250,00
FG 536/3	128	265,00
FG 536/PR-100	289	217,50
FG 537/1	129	1.400,00
FG 537/AL1	129	1.450,00
FG 537/AL2	129	1.600,00
FG 537/AL3	129	1.900,00
FG 538/1	129	800,00
FG 538/2	129	880,00
FG 539/1	129	1.150,00
FG 539/AL1	129	2.750,00
FG 540/1	129	1.050,00
FG 540/2	129	1.200,00
FG 540/FO86	289	77,50
FG 540/FO107-15	290	63,00
FG 540/FO107-8	290	44,00
FG 542/4	130	290,00
FG 542/VO28.5	290	75,50
FG 542/VO27	290	32,50
FG 543/DG1	128	650,00
FG 543/DG2	128	770,00
FG 543/GF	290	194,00
FG 544/1	130	195,00
FG 544/2	130	216,00
FG 544/3	130	232,00
FG 544/4	130	278,00
FG 544/TR74	290	68,50
FG 544/TA	290	195,50
FG 545/1	130	40,00
FG 545/2	130	46,00
FG 545/3	130	49,00
FG 545/4	130	52,00
FG 545/L80	290	213,00
FG 545/L95	290	239,00
FG 545/A80	291	113,50
FG 545/A95	291	172,50
FG 545/A105	291	199,00

CODICE	PAGINA	€/Pz
FG 545/A115	291	210,50
FG 546/DG	129	320,00
FG 546/A7	130	25,00
FG 546/A8	130	25,00
FG 546/A10	130	25,00
FG 546/A12	130	25,00
FG 546/A13	130	25,00
FG 546/A14	130	26,00
FG 546/A15	130	28,00
FG 546/A16	130	28,00
FG 546/A17	130	28,00
FG 546/A18	130	28,00
FG 546/A19	130	28,00
FG 546/GA1	291	87,50
FG 547/DG	129	205,00
FG 547/A13	130	31,50
FG 547/A14	130	31,50
FG 547/A15	130	31,50
FG 547/A16	130	31,50
FG 547/A17	130	31,50
FG 547/A18	130	31,50
FG 547/A19	130	31,50
FG 547/A21	130	35,00
FG 547/A22	130	35,00
FG 547/A24	130	36,00
FG 547/A27	130	42,00
FG 547/A30	130	46,00
FG 547/A32	130	50,00
FG 547/A34	130	60,00
FG 547/A36	130	68,00
FG 547/A41	130	88,00
FG 547/VO-AL1	291	207,00
FG 548/A7	130	27,00
FG 548/A8	130	27,00
FG 548/A10	130	27,00
FG 548/A12	130	27,00
FG 548/A13	130	27,00
FG 548/A14	130	27,00
FG 548/A15	130	28,00
FG 548/A16	130	28,00
FG 548/A17	130	28,00
FG 548/A18	130	28,00
FG 548/A19	130	28,00
FG 548/A21	130	33,00
FG 548/A22	130	35,00
FG 548/PO-V	291	920,00
FG 549/A13	130	33,00
FG 549/A14	130	33,00
FG 549/A15	130	33,00
FG 549/A16	130	33,00
FG 549/A17	130	34,00
FG 549/A18	130	34,00
FG 549/A19	130	34,00
FG 549/A21	130	38,00
FG 549/A22	130	38,00
FG 549/A24	130	40,00
FG 549/A27	130	43,00
FG 549/A30	130	46,00
FG 549/A32	130	49,00
FG 549/A34	130	60,00
FG 549/A36	130	68,00
FG 549/A41	130	88,00
FG 550/GA1	292	110,00
FG 551/1	131	240,00
FG 551/SC28	292	48,50
FG 551/SC34	292	69,00
FG 552/1	131	275,00

CODICE	PAGINA	€/Pz
FG 552/2	131	275,00
FG 552/3	131	310,00
FG 552/SC34	292	56,50
FG 553/1	131	295,00
FG 554/A80	292	161,00
FG 554/A83	292	139,50
FG 554/A95	292	153,00
FG 554/A100	292	195,00
FG 554/A103	292	204,50
FG 555/GA1	293	86,50
FG 555/GA2	293	93,50
FG 555/GA65	293	69,00
FG 556/PO-SC1	293	135,00
FG 556/PO-SC2	293	90,00
FG 556/PO-SC3	293	242,50
FG 556/PO-SC4	293	262,00
FG 557/SC-V	293	148,00
FG 557/SC-RI	294	519,50
FG 558/2	131	220,00
FG 559/1	131	220,00
FG 559/2	131	230,00
FG 560/A	128	72,00
FG 560/FO92	294	62,00
FG 561	128	155,00
FG 562	128	60,00
FG 566/PO-D1	294	322,50
FG 566/PO-D2	294	200,00
FG 566/PO-D3	294	360,00
FG 570/SA-85	295	136,50
FG 570/SA-140	295	187,00
FG 580/A	131	270,00
FG 580/B	131	370,00
FG 580/BP-65	295	86,50
FG 580/BP-80	295	139,50
FG 580/BP-85	295	129,00
FG 581/A	131	800,00
FG 581/B	131	1.320,00
FG 582/BP-85	295	145,00
FG 582/BP-95	295	160,50
FG 582/BP-109	295	197,50
FG 582/BP-100	295	179,50
FG 582/BP-110	296	179,50
FG 582/BP-111	296	194,50
FG 582/BP-120	296	214,50
FG 584/BP-ES1	296	193,00
FG 585/BP-MR125	296	325,50
FG 585/BP-MR155	296	325,50
FG 585/BP-MR135	296	343,00
FG 585/BP-MR136	297	343,00
FG 590/GO	297	191,50
FG 592/E18	297	44,00
FG 592/E20	297	46,50
FG 592/E24	297	46,50
FG 592/M24	297	46,50
FG 592/M26	297	46,50
FG 595/B11	297	10,50
FG 600/B5.5	22	6,70
FG 600/B6	22	6,70
FG 600/B7	22	6,90
FG 600/B8	22	7,20
FG 600/B9	22	7,30
FG 600/B10	22	7,50
FG 600/B11	22	8,30
FG 600/B12	22	8,90
FG 600/B13	22	8,90
FG 600/B14	22	10,50
FG 600/B15	22	11,90

CODICE	PAGINA	€/Pz
FG 600/B16	22	12,50
FG 600/B17	22	13,20
FG 600/B18	22	13,90
FG 600/B19	22	14,50
FG 600/B20	22	15,80
FG 600/B21	22	17,00
FG 600/B22	22	17,70
FG 600/B23	22	19,00
FG 600/B24	22	20,00
FG 600/B25	22	21,00
FG 600/B26	22	22,70
FG 600/B27	22	24,20
FG 600/B28	22	25,20
FG 600/B29	22	26,80
FG 600/B30	22	29,40
FG 600/B32	22	32,50
FG 600/B34	22	51,00
FG 600/B36	22	62,00
FG 600/B38	22	72,00
FG 600/B41	22	85,00
FG 600/B46	22	115,00
FG 600/B50	22	170,00
FG 600/B55	22	268,00
FG 600/B60	22	352,00
FG 600/B65	22	455,00
FG 600/B70	22	505,00
FG 600/B75	22	590,00
FG 600/B80	22	680,00
FG 600/ST7	22	78,00
FG 600/ST9	22	98,00
FG 600/ST11	22	120,00
FG 600/SP6	22	72,00
FG 600/SP9	22	102,00
FG 600/SP11	22	125,00
FG 600/SC17	22	182,00
FG 600/SC16	22	232,00
FG 600/SC25	22	390,00
FG 600/L10	23	11,10
FG 600/L11	23	11,60
FG 600/L12	23	12,50
FG 600/L13	23	12,90
FG 600/L14	23	13,90
FG 600/L15	23	15,00
FG 600/L16	23	16,00
FG 600/L17	23	17,10
FG 600/L18	23	18,30
FG 600/L19	23	20,00
FG 600L/SC10	23	155,00
FG 600/IN1	23	7,50
FG 600/IN2	23	8,00
FG 600/IN3	23	9,50
FG 600/IN4	23	9,30
FG 600/IN5	23	10,70
FG 600/IN6	23	11,50
FG 600/IN7	23	13,50
FG 600/IN8	23	13,70
FG 600/IN9	23	14,80
FG 600/IN10	23	17,00
FG 600/IN11	23	18,50
FG 600/IN12	23	20,80
FG 600/IN13	23	22,00
FG 600/IN14	23	25,50
FG 600/IN15	23	29,00
FG 600/IN16	23	33,00
FG 600/IN17	23	41,00
FG 600/IN18	23	52,00
FG 600/IN19	23	53,00

CODICE	PAGINA	€/Pz
FG 600/IN20	23	64,00
FG 600IN/SC13	23	182,00
FG 600IN/SP6	23	62,00
FG 600IN/SP9	23	110,00
FG 600IN/SP11	23	150,00
FG 600/E6x8	26	10,50
FG 600/E10x12	26	11,00
FG 600/E14x18	26	12,00
FG 600/E20x24	26	17,00
FG 600E/S4	26	53,56
FG 601/B10	24	7,00
FG 601/B11	24	7,00
FG 601/B12	24	7,00
FG 601/B13	24	7,50
FG 601/B14	24	8,10
FG 601/B15	24	9,20
FG 601/B16	24	9,20
FG 601/B17	24	9,20
FG 601/B18	24	9,20
FG 601/B19	24	10,80
FG 601/B20	24	10,80
FG 601/B21	24	10,80
FG 601/B22	24	14,00
FG 601/B23	24	14,00
FG 601/B24	24	14,00
FG 601/B25	24	17,80
FG 601/B27	24	17,80
FG 601/B28	24	20,00
FG 601/B30	24	20,00
FG 601/B32	24	26,00
FG 601/B34	24	26,00
FG 601/B35	24	29,00
FG 601/B36	24	30,00
FG 601/B38	24	32,00
FG 601/B41	24	38,00
FG 601/B46	24	46,00
FG 601/B50	24	68,00
FG 601/B55	24	88,00
FG 601/B60	24	90,00
FG 601/B65	24	102,00
FG 601/B70	24	135,00
FG 601/B75	24	150,00
FG 601/B80	24	190,00
FG 602/B6x7	24	4,50
FG 602/B8x9	24	4,70
FG 602/B8X10	24	5,50
FG 602/B10X11	24	5,50
FG 602/B12X13	24	5,80
FG 602/B14X15	24	7,20
FG 602/B16X17	24	8,20
FG 602/B18X19	24	9,50
FG 602/B20X22	24	11,90
FG 602/B21X23	24	13,50
FG 602/B22X24	24	13,50
FG 602/B24X26	24	15,20
FG 602/B25X28	24	18,00
FG 602/B27X29	24	19,00
FG 602/B30X32	24	20,00
FG 602/B34X36	24	45,00
FG 602/B35X38	24	58,00
FG 602/B36X41	24	59,00
FG 602/B41X46	24	75,00
FG 602/B46X50	24	90,00
FG 602/ST7	24	52,00
FG 602/ST9	24	76,00
FG 602/SP6	25	44,00
FG 602/SP9	25	80,00

CODICE	PAGINA	€/Pz
FG 602/SP13	25	158,00
FG 602/SC8	25	58,00
FG 602/SC13	25	145,00
FG 602/IN1	25	5,50
FG 602/IN2	25	6,50
FG 602/IN3	25	7,20
FG 602/IN4	25	7,70
FG 602/IN5	25	8,30
FG 602/IN6	25	10,30
FG 602/IN7	25	11,80
FG 602/IN8	25	13,50
FG 602/IN9	25	18,50
FG 602/IN10	25	21,50
FG 602/IN11	25	23,50
FG 602IN/SP9	25	115,00
FG 602/C6x7	26	5,00
FG 602/C8x9	26	5,50
FG 602/C10x11	26	5,50
FG 602/C12x13	26	7,00
FG 602/C14X15	26	7,20
FG 602/C16X17	26	10,20
FG 602/C18X19	26	10,50
FG 602/C20X22	26	14,00
FG 602/C21X23	26	14,00
FG 602C/SP6	26	50,00
FG 602C/SP9	26	92,00
FG 603/E7	112	22,70
FG 603/E8	112	22,70
FG 603/E9	112	23,70
FG 603/E10	112	24,80
FG 603/E11	112	25,80
FG 603/E12	112	25,80
FG 603/E13	112	27,90
FG 603/E14	112	27,90
FG 603/E16	112	30,90
FG 603/E17	112	33,00
FG 603/E18	112	34,00
FG 603/E19	112	35,00
FG 603/SP6	112	175,00
FG 603/SP9	112	257,50
FG 603/SP11	112	309,00
FG 603/SC12	112	335,00
FG 603/S26	120	875,00
FG 603/EL	120	55,00
FG 603/EL1	120	154,50
FG 603/GU9	120	118,50
FG 603/GU10	120	118,50
FG 603/TA1	120	278,00
FG 604/A24	33	24,20
FG 604/A27	33	27,80
FG 604/A30	33	34,50
FG 604/A32	33	35,50
FG 604/A36	33	51,50
FG 604/A41	33	58,70
FG 604/A46	33	71,00
FG 604/A50	33	84,50
FG 604/A55	33	96,00
FG 604/A60	33	115,00
FG 604/A65	33	142,00
FG 604/A70	33	170,00
FG 604/A75	33	185,00
FG 604/A80	33	298,00
FG 604/A85	33	338,00
FG 604/A90	33	380,00
FG 604/A95	33	443,00
FG 604/A100	33	546,00
FG 604/A105	33	616,00

CODICE	PAGINA	€/Pz
FG 604/A110	33	638,00
FG 604/A115	33	716,00
FG 604/A120	33	1.020,00
FG 604/A125	33	1.298,00
FG 604/A130	33	1.535,00
FG 604/A135	33	1.680,00
FG 604/B24	33	26,00
FG 604/B27	33	27,00
FG 604/B30	33	33,00
FG 604/B32	33	35,00
FG 604/B36	33	50,00
FG 604/B41	33	60,00
FG 604/B46	33	76,00
FG 604/B50	33	88,00
FG 604/B55	33	102,00
FG 604/B60	33	120,00
FG 604/B65	33	148,00
FG 604/B70	33	190,00
FG 604/B75	33	202,00
FG 604/B80	33	305,00
FG 604/B85	33	335,00
FG 604/B90	33	375,00
FG 604/B95	33	385,00
FG 604/B100	33	530,00
FG 604/B105	33	598,00
FG 604/B110	33	660,00
FG 604/B115	33	750,00
FG 604/B120	33	780,00
FG 604/B125	33	885,00
FG 604/D24	34	46,00
FG 604/D27	34	48,00
FG 604/D30	34	52,00
FG 604/D32	34	59,00
FG 604/D36	34	65,00
FG 604/D41	34	82,00
FG 604/D46	34	90,00
FG 604/D50	34	107,00
FG 604/D55	34	118,00
FG 604/D60	34	152,00
FG 604/D65	34	180,00
FG 604/D70	34	200,00
FG 604/D75	34	222,00
FG 604/D80	34	252,00
FG 604/D85	34	265,00
FG 604/D90	34	462,00
FG 604/D95	34	494,00
FG 604/D100	34	525,00
FG 604D/PR1	34	34,00
FG 604D/PR2	34	52,00
FG 604D/PR3	34	73,00
FG 604D/PR4	34	97,00
FG 605/A6	34	16,00
FG 605/A7	34	16,00
FG 605/A8	34	16,00
FG 605/A9	34	17,00
FG 605/A10	34	17,50
FG 605/A11	34	18,00
FG 605/A12	34	18,80
FG 605/A13	34	19,30
FG 605/A14	34	20,50
FG 605/A15	34	21,50
FG 605/A16	34	23,70
FG 605/A17	34	23,70
FG 605/A18	34	25,90
FG 605/A19	34	25,90
FG 605/ST9-B	34	190,00
FG 605/ST11-B	34	232,00

CODICE	PAGINA	€/Pz
FG 605/B6	34	12,80
FG 605/B7	34	12,80
FG 605/B8	34	13,20
FG 605/B9	34	13,20
FG 605/B10	34	13,20
FG 605/B11	34	13,80
FG 605/B12	34	14,60
FG 605/B13	34	15,30
FG 605/B14	34	15,90
FG 605/B15	34	17,10
FG 605/B16	34	18,20
FG 605/B17	34	20,00
FG 605/B18	34	21,00
FG 605/B19	34	22,00
FG 605/B21	34	31,50
FG 605/B22	34	31,50
FG 605/B24	34	37,80
FG 605/B27	34	50,40
FG 605/B30	34	71,40
FG 605/B32	34	73,50
FG 605/SP6	35	110,00
FG 605/SP9	35	158,00
FG 605/SP11	35	191,00
FG 605/SC12	35	198,00
FG 605/SC15	35	258,00
FG 605/SC19	35	488,00
FG 606/B8	35	10,80
FG 606/B9	35	11,10
FG 606/B10	35	11,40
FG 606/B11	35	11,40
FG 606/B12	35	12,10
FG 606/B13	35	12,70
FG 606/B14	35	13,30
FG 606/B15	35	14,60
FG 606/B16	35	14,90
FG 606/B17	35	16,30
FG 606/B18	35	17,80
FG 606/B19	35	18,10
FG 606/SP6	35	93,00
FG 606/SP9	35	132,00
FG 609/A8x10	26	11,90
FG 609/A10x12	26	12,80
FG 609/A11x13	26	15,40
FG 609/A14x17	26	19,50
FG 609/A15x17	26	22,00
FG 609/A16x18	26	23,00
FG 609/A19x22	26	27,00
FG 609A/S5	26	102,00
FG 610/FL8	35	19,50
FG 610/FL9	35	19,50
FG 610/FL10	35	20,50
FG 610/FL11	35	21,00
FG 610/FL12	35	22,00
FG 610/FL13	35	22,60
FG 610/FL14	35	25,00
FG 610/FL15	35	25,20
FG 610/FL16	35	27,00
FG 610/FL17	35	29,00
FG 610/FL18	35	30,00
FG 610/FL19	35	30,00
FG 610FL/SP6	35	155,00
FG 610FL/SP9	35	236,00
FG 610FL/SP11	35	285,00
FG 613/A6	28	13,70
FG 613/A7	28	13,70
FG 613/A8	28	13,70
FG 613/A9	28	13,70

CODICE	PAGINA	€/Pz
FG 613/A10	28	14,70
FG 613/A11	28	14,70
FG 613/A12	28	16,60
FG 613/A13	28	19,90
FG 613/A14	28	19,90
FG 613/A15	28	21,50
FG 613/A16	28	23,00
FG 613/A17	28	24,00
FG 613/A18	28	25,00
FG 613/A19	28	28,00
FG 613/A20	28	28,30
FG 613/A21	28	33,60
FG 613/A22	28	35,70
FG 613/A23	28	38,90
FG 613/A24	28	41,90
FG 613/A25	28	46,20
FG 613/A26	28	49,40
FG 613/A27	28	55,10
FG 613/A30	28	66,00
FG 613/A32	28	70,00
FG 613/S9	28	185,00
FG 613/S11	28	215,00
FG 613/S17	28	362,00
FG 614/A6x7	28	12,40
FG 614/A8x9	28	14,70
FG 614/A10x11	28	15,80
FG 614/A12x13	28	18,40
FG 614/A14x15	28	20,00
FG 614/A16x17	28	22,00
FG 614/A18x19	28	24,00
FG 614/A20x22	28	27,30
FG 614/A21x23	28	31,00
FG 614/A24x26	28	36,80
FG 614/A25x28	28	42,00
FG 614/A27x29	28	48,30
FG 614/A30x32	28	56,00
FG 614A/S8	28	158,00
FG 614A/S13	28	375,00
FG 614/AS1	28	5,60
FG 614/AS2	28	7,40
FG 614/AS3	28	12,00
FG 614/B6x7	29	5,60
FG 614/B8x9	29	5,60
FG 614/B10x11	29	6,80
FG 614/B12x13	29	8,00
FG 614/B14x15	29	8,60
FG 614/B16x17	29	9,00
FG 614/B18x19	29	12,10
FG 614/B20x22	29	15,50
FG 614/B21x23	29	16,60
FG 614/B24x26	29	18,80
FG 614/B25x28	29	21,50
FG 614/B27x29	29	24,50
FG 614/B30x32	29	27,50
FG 614B/S8	29	75,00
FG 614B/S13	29	185,00
FG 614/C6x7	29	24,00
FG 614/C8x9	29	24,00
FG 614/C10x11	29	24,00
FG 614/C12x13	29	28,00
FG 614/C14x15	29	32,00
FG 614/C16x17	29	38,00
FG 614/C18x19	29	45,00
FG 614/C20x22	29	45,00
FG 614/C21x23	29	45,00
FG 614/C24x27	29	85,00
FG 614/C30x32	29	92,00

CODICE	PAGINA	€/Pz
FG 614C/S8	29	265,00
FG 614C/S11	29	485,00
FG 615/B6x7	27	8,50
FG 615/B8x9	27	9,20
FG 615/B10x11	27	10,80
FG 615/B12x13	27	12,00
FG 615/B14x15	27	13,00
FG 615/B16x17	27	14,60
FG 615/B18x19	27	17,50
FG 615/B20x22	27	19,50
FG 615/B21x23	27	22,50
FG 615/B24x26	27	25,00
FG 615/B24x27	27	26,50
FG 615/B25x28	27	29,50
FG 615/B27x29	27	31,00
FG 615/B30x32	27	33,00
FG 615/B34x36	27	63,00
FG 615/B36x41	27	70,00
FG 615/B46x50	27	132,00
FG 615/SC8	27	113,00
FG 615/SC13	27	250,00
FG 616/A8	29	17,50
FG 616/A10	29	19,50
FG 616/A12	29	22,00
FG 616/A13	29	22,50
FG 616/A14	29	23,50
FG 616/A17	29	28,00
FG 616A/S6	29	135,00
FG 618/A6	30	30,50
FG 618/A7	30	30,50
FG 618/A8	30	31,00
FG 618/A9	30	31,00
FG 618/A10	30	34,00
FG 618/A11	30	34,50
FG 618/A12	30	35,00
FG 618/A13	30	38,00
FG 618/A14	30	38,00
FG 618/A15	30	45,50
FG 618/A16	30	45,50
FG 618/A17	30	45,50
FG 618/A18	30	45,50
FG 618/A19	30	56,00
FG 618/A20	30	56,00
FG 618/A21	30	56,00
FG 618/A22	30	56,00
FG 618/A23	30	56,00
FG 618/A24	30	56,00
FG 618/S7B	30	257,50
FG 618/S7	30	278,50
FG 618/S10	30	404,50
FG 618/S18	30	762,50
FG 618/E6	30	36,00
FG 618/E7	30	36,00
FG 618/E8	30	40,00
FG 618/E10	30	40,00
FG 618/E12	30	47,50
FG 618/E14	30	59,00
FG 618/E16	30	59,00
FG 618/E18	30	60,00
FG 618/E20	30	60,00
FG 618E/S9	31	439,00
FG 619/H3	30	34,50
FG 619/H4	30	34,50
FG 619/H5	30	34,50
FG 619/H6	30	42,00
FG 619/H8	30	43,50
FG 619/H10	30	48,50

CODICE	PAGINA	€/Pz
FG 619H/S5	30	191,50
FG 619H/S6	30	238,50
FG 619/TX20	31	39,50
FG 619/TX25	31	39,50
FG 619/TX27	31	39,50
FG 619/TX30	31	39,50
FG 619/TX40	31	43,50
FG 619/TX45	31	45,50
FG 619/TX50	31	48,50
FG 619/TX55	31	53,00
FG 619TX/S8	31	350,50
FG 621/H2	31	14,30
FG 621/H2,5	31	14,30
FG 621/H3	31	14,30
FG 621/H3,5	31	14,30
FG 621/H4	31	15,60
FG 621/H4,5	31	16,80
FG 621/H5	31	18,50
FG 621/H6	31	21,50
FG 621/H7	31	21,50
FG 621/H8	31	22,00
FG 621/H9	31	25,00
FG 621/H10	31	27,80
FG 621/H12	31	29,50
FG 621/H14	31	38,00
FG 621H/S8	31	139,00
FG 621H/S8B	31	132,00
FG 621H/S8C	31	152,00
FG 621H/S14	31	298,00
FG 621/TX6	32	15,80
FG 621/TX7	32	15,80
FG 621/TX8	32	15,80
FG 621/TX9	32	15,80
FG 621/TX10	32	15,80
FG 621/TX15	32	15,80
FG 621/TX20	32	15,80
FG 621/TX25	32	16,80
FG 621/TX27	32	16,80
FG 621/TX30	32	16,80
FG 621/TX40	32	20,00
FG 621/TX45	32	23,00
FG 621/TX50	32	25,00
FG 621TX/S8B	32	145,00
FG 621TX/S13	32	235,00
FG 622/H2	32	20,00
FG 622/H2,5	32	20,00
FG 622/H3	32	20,50
FG 622/H3,5	32	20,50
FG 622/H4	32	22,50
FG 622/H4,5	32	22,50
FG 622/H5	32	24,00
FG 622/H6	32	26,00
FG 622/H7	32	26,00
FG 622/H8	32	32,00
FG 622/H9	32	32,00
FG 622/H10	32	42,00
FG 622/H12	32	52,00
FG 622/H14	32	60,00
FG 622H/S6	32	155,00
FG 622H/S7	32	195,00
FG 624/E4	38	3,50
FG 624/E4,5	38	3,50
FG 624/E5	38	3,50
FG 624/E5,5	38	3,50
FG 624/E6	38	3,50
FG 624/E7	38	3,50
FG 624/E8	38	3,50

INDICE ANALITICO

CODICE	PAGINA	€/Pz
FG 624/E9	38	3,50
FG 624/E10	38	3,50
FG 624/E11	38	3,50
FG 624/E12	38	3,50
FG 624/E13	38	3,50
FG 624/E14	38	3,70
FG 624/S11	38	43,50
FG 624/S12	38	82,50
FG 624/S25A	38	85,00
FG 624/S25	38	90,00
FG 624/S18	39	139,50
FG 624/S45	39	210,00
FG 624E/L4	40	7,50
FG 624E/L5	40	7,50
FG 624E/L6	40	7,50
FG 624E/L7	40	7,50
FG 624E/L8	40	8,00
FG 624E/L9	40	8,00
FG 624E/L10	40	8,00
FG 624E/L11	40	8,00
FG 624E/L12	40	8,00
FG 624E/L13	40	8,00
FG 624E/L14	40	8,00
FG 624L/S11	40	98,00
FG 624/S29	40	210,00
FG 624A/IN1	40	3,60
FG 624A/IN2	40	3,60
FG 624A/IN3	40	3,60
FG 624A/IN4	40	3,60
FG 624A/IN5	40	3,60
FG 624A/IN6	40	3,60
FG 624A/IN7	40	3,60
FG 624A/IN8	40	3,60
FG 624A/IN9	40	3,60
FG 624A/IN10	40	3,60
FG 624A/IN11	40	3,60
FG 624A/IN12	40	3,60
FG 624A/INS12	41	55,00
FG 624/U4	41	3,80
FG 624/U4.5	41	3,80
FG 624/U5	41	3,80
FG 624/U5.5	41	3,80
FG 624/U6	41	3,80
FG 624/U7	41	3,80
FG 624/U8	41	4,20
FG 624/U9	41	4,20
FG 624/U10	41	4,20
FG 624/U11	41	4,20
FG 624/U12	41	4,20
FG 624/U13	41	4,20
FG 624/U14	41	4,20
FG 624U/S13	41	64,00
FG 624/TX4	41	6,00
FG 624/TX5	41	6,00
FG 624/TX6	41	6,00
FG 624/TX7	41	6,00
FG 624/TX8	41	6,00
FG 624/TX10	41	6,00
FG 624TX/S6	41	48,00
FG 624TX/S17	41	78,50
FG 624/CR14	44	40,00
FG 624/RT14	44	65,00
FG 624/FR14	44	43,50
FG 624/MCR	44	36,00
FG 624/MCH	44	36,00
FG 624/Q14	44	39,50
FG 624/ES14	44	7,50

CODICE	PAGINA	€/Pz
FG 624/CS14	45	27,00
FG 624/GR14B	45	16,00
FG 624/GR14C	45	11,00
FG 624/PA50	45	8,50
FG 624/PA100	45	9,00
FG 624/PR50	45	7,50
FG 624/PR100	45	8,00
FG 624/PR150	45	8,50
FG 624/PRF150	45	12,50
FG 624/SN14	45	15,50
FG 624/B8	46	6,00
FG 624/B9	46	6,00
FG 624/B10	46	6,00
FG 624/B11	46	6,00
FG 624/B12	46	6,00
FG 624/B13	46	6,00
FG 624/B14	46	6,00
FG 624/B15	46	6,00
FG 624/B16	46	6,50
FG 624/B17	46	6,50
FG 624/B18	46	6,50
FG 624/B19	46	7,50
FG 624/B21	46	7,50
FG 624/B22	46	7,50
FG 624/B23	46	7,50
FG 624B/S15	46	118,50
FG 624B/S16	46	157,00
FG 624B/S22	46	230,00
FG 624B/L8	46	10,80
FG 624B/L9	46	10,80
FG 624B/L10	46	10,80
FG 624B/L11	46	10,80
FG 624B/L12	46	10,80
FG 624B/L13	46	10,80
FG 624B/L14	46	10,80
FG 624B/L15	46	12,00
FG 624B/L16	46	12,00
FG 624B/L17	46	12,00
FG 624B/L18	46	12,00
FG 624B/L19	46	12,00
FG 624B/L21	46	14,00
FG 624B/L22	46	14,00
FG 624B/L23	46	14,00
FG 624L/S15	47	185,50
FG 624L/S16	47	227,00
FG 624B/LS20	47	319,50
FG 624/C6	47	5,00
FG 624/C7	47	5,00
FG 624/C8	47	5,00
FG 624/C9	47	5,00
FG 624/C10	47	5,00
FG 624/C11	47	5,00
FG 624/C12	47	5,00
FG 624/C13	47	5,00
FG 624/C14	47	5,00
FG 624/C15	47	5,50
FG 624/C16	47	5,50
FG 624/C17	47	5,50
FG 624/C18	47	5,50
FG 624/C19	47	5,50
FG 624/C20	47	5,50
FG 624/C21	47	6,00
FG 624/C22	47	6,00
FG 624/C24	47	6,50
FG 624C/S18	47	108,50
FG 624C/S22	48	216,50
FG 624/L6	48	8,50

CODICE	PAGINA	€/Pz
FG 624/L7	48	8,50
FG 624/L8	48	8,50
FG 624/L9	48	8,50
FG 624/L10	48	8,50
FG 624/L11	48	8,50
FG 624/L12	48	8,50
FG 624/L13	48	8,50
FG 624/L14	48	9,20
FG 624/L15	48	11,00
FG 624/L16	48	11,00
FG 624/L17	48	11,50
FG 624/L18	48	12,00
FG 624/L19	48	12,00
FG 624/L20	48	12,50
FG 624/L21	48	12,50
FG 624/L22	48	13,00
FG 624/L24	48	13,50
FG 624L/S18	48	204,00
FG 624L/S20	49	278,50
FG 624C/IN1	49	5,50
FG 624C/IN2	49	5,50
FG 624C/IN3	49	5,50
FG 624C/IN4	49	5,50
FG 624C/IN5	49	5,50
FG 624C/IN6	49	6,00
FG 624C/IN7	49	6,00
FG 624C/IN8	49	6,00
FG 624C/IN9	49	6,50
FG 624C/IN10	49	6,50
FG 624C/IN11	49	6,50
FG 624C/IN12	49	7,00
FG 624C/IN13	49	7,00
FG 624C/IN14	49	7,50
FG 624C/IN15	49	8,20
FG 624C/IN16	49	8,60
FG 624C/INS13	49	90,00
FG 624C/INS23	49	237,00
FG 624B/TX5	50	7,00
FG 624B/TX6	50	7,00
FG 624B/TX7	50	7,00
FG 624B/TX8	50	7,00
FG 624B/TX10	50	7,00
FG 624B/TX12	50	7,00
FG 624B/TX14	50	7,00
FG 624B/TX16	50	7,00
FG 624TX/S8	50	62,00
FG 624L/TX6	50	11,00
FG 624L/TX7	50	11,00
FG 624L/TX8	50	11,00
FG 624L/TX10	50	11,00
FG 624L/TX12	50	11,00
FG 624L/TX14	50	11,00
FG 624L/TX16	50	11,00
FG 624L/TX18	50	11,00
FG 624L/TXS8	50	95,00
FG 624B/TXS10	50	135,00
FG 624/CR38	52	43,50
FG 624/CS38	52	34,00
FG 624/ES38	52	13,50
FG 624/Q38	53	43,50
FG 624B/PA75	53	10,50
FG 624B/PA125	53	11,50
FG 624B/PA150	53	15,00
FG 624B/PA250	53	20,50
FG 624/SN38	53	15,00
FG 624B/S80	53	200,00
FG 624/AD1	81	6,00

CODICE	PAGINA	€/Pz
FG 624/AD2	81	7,50
FG 624/AD3	81	8,50
FG 624/AM1	81	9,50
FG 624/AM2	81	12,50
FG 624/AD4	81	12,50
FG 624/AD5	81	15,50
FG 624E/CR38	114	149,00
FG 624E/8	114	16,50
FG 624E/10	114	16,50
FG 624E/12	114	17,00
FG 624E/13	114	17,50
FG 624E/14	114	18,50
FG 624E/17	114	20,50
FG 624E/19	114	22,50
FG 624E/22	114	24,50
FG 624E/T38	114	87,00
FG 624E/PR150	115	58,00
FG 624E/PR250	115	72,00
FG 624E/S16	115	670,00
FG 624E/S10	115	465,00
FG 624E/S6	115	130,00
FG 624L/TX10	199	11,00
FG 625/A8	54	5,50
FG 625/A9	54	5,50
FG 625/A10	54	5,50
FG 625/A11	54	5,50
FG 625/A12	54	5,50
FG 625/A13	54	5,50
FG 625/A14	54	5,50
FG 625/A15	54	5,50
FG 625/A16	54	5,50
FG 625/A17	54	5,50
FG 625/A18	54	6,50
FG 625/A19	54	6,50
FG 625/A20	54	7,00
FG 625/A21	54	7,00
FG 625/A22	54	8,50
FG 625/A23	54	9,00
FG 625/A24	54	9,00
FG 625/A25	54	9,50
FG 625/A26	54	9,50
FG 625/A27	54	9,50
FG 625/A30	54	9,50
FG 625/A32	54	10,00
FG 625A/S11	54	80,50
FG 625A/S10	54	101,00
FG 625A/S12	54	134,00
FG 625A/S25	54	278,50
FG 625L/A10	55	13,50
FG 625L/A11	55	13,50
FG 625L/A12	55	13,50
FG 625L/A13	55	13,50
FG 625L/A14	55	13,50
FG 625L/A15	55	13,50
FG 625L/A16	55	14,00
FG 625L/A17	55	14,00
FG 625L/A18	55	14,00
FG 625L/A19	55	14,00
FG 625L/A20	55	15,00
FG 625L/A21	55	15,00
FG 625L/A22	55	17,00
FG 625L/A23	55	19,00
FG 625L/A24	55	20,00
FG 625L/A25	55	20,00
FG 625L/A26	55	20,00
FG 625L/A27	55	23,00
FG 625L/A28	55	26,00

CODICE	PAGINA	€/Pz
FG 625L/A29	55	26,00
FG 625L/A30	55	27,00
FG 625L/A32	55	27,00
FG 625L/A36	55	45,50
FG 625AL/S11	55	165,00
FG 625AL/S9	55	216,50
FG 625A/S37	55	489,50
FG 625/C8	56	5,50
FG 625/C10	56	5,50
FG 625/C11	56	5,50
FG 625/C12	56	5,50
FG 625/C13	56	5,50
FG 625/C14	56	5,50
FG 625/C15	56	5,50
FG 625/C16	56	5,50
FG 625/C17	56	5,50
FG 625/C18	56	6,50
FG 625/C19	56	6,50
FG 625/C20	56	7,00
FG 625/C21	56	7,00
FG 625/C22	56	8,50
FG 625/C23	56	9,00
FG 625/C24	56	9,00
FG 625/C25	56	9,50
FG 625/C26	56	9,50
FG 625/C27	56	9,50
FG 625/C28	56	9,50
FG 625/C29	56	9,50
FG 625/C30	56	9,50
FG 625/C32	56	10,00
FG 625/S11	56	77,50
FG 625/S12B	56	95,00
FG 625/S12	56	124,00
FG 625C/S25	56	264,00
FG 625/L8	57	10,50
FG 625/L9	57	10,50
FG 625/L10	57	10,50
FG 625/L11	57	10,50
FG 625/L12	57	10,50
FG 625/L13	57	10,50
FG 625/L14	57	10,50
FG 625/L15	57	10,50
FG 625/L16	57	10,50
FG 625/L17	57	10,50
FG 625/L18	57	11,00
FG 625/L19	57	11,00
FG 625/L20	57	12,50
FG 625/L21	57	13,50
FG 625/L22	57	15,00
FG 625/L23	57	15,00
FG 625/L24	57	15,00
FG 625/L25	57	17,00
FG 625/L27	57	20,00
FG 625/L30	57	25,50
FG 625/L32	57	26,50
FG 625/L36	57	45,50
FG 625L/S12	57	136,00
FG 625L/S6	57	124,00
FG 625/S37	57	465,00
FG 625C/IN1	58	5,50
FG 625C/IN2	58	5,50
FG 625C/IN3	58	5,50
FG 625C/IN4	58	5,50
FG 625C/IN5	58	5,50
FG 625C/IN6	58	5,50
FG 625C/IN7	58	5,50
FG 625C/IN8	58	5,50

CODICE	PAGINA	€/Pz
FG 625C/IN9	58	5,50
FG 625C/IN10	58	6,50
FG 625C/IN11	58	7,00
FG 625C/IN12	58	7,20
FG 625C/IN13	58	8,70
FG 625C/IN14	58	9,50
FG 625C/IN15	58	9,80
FG 625C/IN16	58	11,20
FG 625C/IN17	58	11,20
FG 625C/IN18	58	11,50
FG 625C/IN19	58	11,50
FG 625IN/S11	58	75,00
FG 625IN/S24	58	270,00
FG 625/TX8	59	8,00
FG 625/TX10	59	8,00
FG 625/TX12	59	8,00
FG 625/TX14	59	8,00
FG 625/TX16	59	8,00
FG 625/TX18	59	8,00
FG 625/TX20	59	8,00
FG 625/TX22	59	8,00
FG 625/TX24	59	8,00
FG 625TX/S9	59	80,50
FG 625L/TX8	60	13,50
FG 625L/TX10	60	14,00
FG 625L/TX12	60	14,00
FG 625L/TX14	60	14,00
FG 625L/TX16	60	14,00
FG 625L/TX18	60	14,00
FG 625L/TX20	60	14,00
FG 625L/TX22	60	14,00
FG 625L/TX24	60	14,00
FG 625LTX/S9	60	134,00
FG 625TX/S23	62	232,00
FG 625TX/S9B	62	77,50
FG 625TX/S13	62	160,00
FG 625/CR12	68	54,00
FG 625/RT12	68	82,00
FG 625/FR12	68	57,00
FG 625/CS12	69	43,50
FG 625/Q12	69	51,50
FG 625/ES12	69	16,50
FG 625/SN12	69	23,00
FG 625/PA50	69	11,50
FG 625/PA75	69	13,50
FG 625/PA125	69	16,00
FG 625/PA250	69	21,00
FG 625/PR50	69	10,50
FG 625/PR75	69	12,00
FG 625/PR125	69	13,50
FG 625/PR250	69	16,00
FG 625/S27	71	190,00
FG 625/S110	71	470,00
FG 625/S74	72	250,00
FG 625/S94	72	300,00
FG 625/SN12R	81	37,50
FG 625/AD1	81	10,50
FG 625/AD2	81	11,00
FG 625/AD3	81	12,50
FG 625/AM1	81	19,00
FG 625AM/S3	81	49,50
FG 625E/CR12	112	160,00
FG 625E/T12	112	93,00
FG 625E/PR125	112	62,00
FG 625E/PR250	112	77,00
FG 625E/10	113	21,70
FG 625E/11	113	21,70

CODICE	PAGINA	€/Pz
FG 625E/12	113	21,70
FG 625E/13	113	21,70
FG 625E/14	113	21,70
FG 625E/17	113	22,70
FG 625E/19	113	24,50
FG 625E/22	113	28,50
FG 625E/24	113	29,50
FG 625E/27	113	36,00
FG 625E/32	113	44,50
FG 625E/S20	113	845,00
FG 625E/S12	113	570,00
FG 625E/S5	114	130,00
FG 626/A8	58	7,00
FG 626/A10	58	7,00
FG 626/A11	58	7,00
FG 626/A12	58	7,00
FG 626/A13	58	7,00
FG 626/A14	58	7,00
FG 626/A15	58	7,00
FG 626/A16	58	7,20
FG 626/A17	58	7,20
FG 626/A18	58	7,20
FG 626/A19	58	7,70
FG 626/A20	58	7,70
FG 626/A21	58	7,70
FG 626/A22	58	8,00
FG 626/A23	58	8,50
FG 626/A24	58	8,50
FG 626/A27	58	10,50
FG 626/A30	58	12,00
FG 626/A32	58	13,00
FG 626/S13	59	105,00
FG 626/S6	59	65,00
FG 626/S23	59	280,00
FG 627/C8	76	6,00
FG 627/C9	76	6,00
FG 627/C10	76	6,00
FG 627/C11	76	6,00
FG 627/C12	76	6,00
FG 627/C13	76	6,50
FG 627/C14	76	6,50
FG 627/C15	76	6,50
FG 627/C16	76	6,50
FG 627/C17	76	6,50
FG 627/C18	76	6,70
FG 627/C19	76	6,70
FG 627/C20	76	7,60
FG 627/C21	76	7,60
FG 627/C22	76	8,20
FG 627/S15B	76	120,00
FG 627/R17	208	28,00
FG 627/R19	208	28,00
FG 627/R21	208	28,00
FG 627/S3	209	85,00
FG 628/L10	77	15,00
FG 628/L11	77	15,00
FG 628/L12	77	15,00
FG 628/L13	77	15,00
FG 628/L14	77	15,00
FG 628/L15	77	15,00
FG 628/L16	77	15,00
FG 628/L17	77	15,00
FG 628/L18	77	19,00
FG 628/L19	77	19,00
FG 628/L21	77	20,00
FG 628/L22	77	20,00
FG 628/L23	77	21,00

CODICE	PAGINA	€/Pz
FG 628/L24	77	21,00
FG 628/L25	77	25,00
FG 628/L27	77	25,00
FG 628/L29	77	33,00
FG 628/L30	77	33,00
FG 628/L32	77	33,00
FG 628/LS19	77	443,00
FG 628/C10	77	8,50
FG 628/C11	77	8,50
FG 628/C12	77	8,50
FG 628/C13	77	8,50
FG 628/C14	77	8,50
FG 628/C15	77	9,50
FG 628/C16	77	9,50
FG 628/C17	77	9,50
FG 628/C18	77	9,50
FG 628/C19	77	9,50
FG 628/C20	77	9,50
FG 628/C21	77	10,50
FG 628/C22	77	10,50
FG 628/C23	77	11,00
FG 628/C24	77	11,00
FG 628/C25	77	12,00
FG 628/C26	77	13,50
FG 628/C27	77	13,50
FG 628/C30	77	14,50
FG 628/C32	77	17,00
FG 628/S10	77	108,50
FG 628/S20	78	278,50
FG 628/TX8	78	11,50
FG 628/TX10	78	11,50
FG 628/TX12	78	12,50
FG 628/TX14	78	12,50
FG 628/TX16	78	12,50
FG 628/TX18	78	12,50
FG 628/TX20	78	12,50
FG 628/TX22	78	13,50
FG 628/TX24	78	13,50
FG 628L/TXS8	78	120,00
FG 628/D10	78	8,50
FG 628/D11	78	8,50
FG 628/D12	78	8,50
FG 628/D13	78	8,50
FG 628/D14	78	8,50
FG 628/D15	78	9,50
FG 628/D16	78	9,50
FG 628/D17	78	9,50
FG 628/D18	78	9,50
FG 628/D19	78	9,50
FG 628/D20	78	9,50
FG 628/D21	78	10,50
FG 628/D22	78	10,50
FG 628/D23	78	11,20
FG 628/D24	78	11,20
FG 628/D27	78	13,50
FG 628/D30	78	14,50
FG 628/D32	78	17,00
FG 628/S12	78	130,00
FG 628/S6	78	95,00
FG 628/PR125	79	15,00
FG 628/PR250	79	16,00
FG 628/PR380	79	21,00
FG 628/AD1	81	11,50
FG 628/AD2	81	12,00
FG 628/AD3	81	21,00
FG 628/R15	208	15,50

INDICE ANALITICO

CODICE	PAGINA	€/Pz
FG 628/R17	208	15,50
FG 628/R19	208	15,50
FG 628/R21	208	16,00
FG 628/R22	208	17,00
FG 628/S3	208	50,00
FG 628/S5	208	78,00
FG 628R/L17	208	26,00
FG 628R/L19	208	26,00
FG 628R/L21	208	26,00
FG 628L/S3	208	98,00
FG 628/S7	208	115,00
FG 628/R17.5	209	20,00
FG 628/R18.5	209	20,00
FG 628/R21.5	209	22,00
FG 628/R22.5	209	22,00
FG 628/R27.5	209	25,00
FG 629/A19	73	14,00
FG 629/A22	73	14,50
FG 629/A24	73	16,00
FG 629/A26	73	16,50
FG 629/A27	73	16,50
FG 629/A28	73	17,00
FG 629/A29	73	17,00
FG 629/A30	73	19,00
FG 629/A32	73	19,00
FG 629/A33	73	20,00
FG 629/A34	73	20,00
FG 629/A35	73	21,50
FG 629/A36	73	22,50
FG 629/A38	73	23,00
FG 629/A41	73	26,00
FG 629/A46	73	34,00
FG 629/A50	73	39,50
FG 629/A55	73	48,50
FG 629/A60	73	57,00
FG 629/B19	73	14,00
FG 629/B22	73	14,50
FG 629/B23	73	14,50
FG 629/B24	73	16,00
FG 629/B26	73	16,50
FG 629/B27	73	16,50
FG 629/B28	73	17,00
FG 629/B29	73	17,00
FG 629/B30	73	19,00
FG 629/B32	73	19,00
FG 629/B33	73	20,00
FG 629/B34	73	20,00
FG 629/B35	73	21,50
FG 629/B36	73	22,50
FG 629/B38	73	23,00
FG 629/B41	73	26,00
FG 629/B46	73	34,00
FG 629/B50	73	39,50
FG 629/B55	73	48,50
FG 629/B60	73	57,00
FG 629A/S10	73	494,50
FG 629B/S10	74	494,50
FG 629A/S15	74	600,00
FG 629B/S15	74	618,00
FG 629/CR34	74	135,00
FG 629/PR200	74	29,00
FG 629/PR400	74	43,50
FG 629/PRL	75	43,50
FG 629/ES34	75	43,50
FG 629/QS34	75	67,00
FG 629/SN34	75	67,00
FG 629/C17	80	23,00

CODICE	PAGINA	€/Pz
FG 629/C18	80	23,00
FG 629/C19	80	23,00
FG 629/C21	80	23,00
FG 629/C22	80	23,00
FG 629/C23	80	23,50
FG 629/C24	80	23,50
FG 629/C27	80	23,50
FG 629/C28	80	23,50
FG 629/C30	80	23,50
FG 629/C32	80	24,50
FG 629/C33	80	26,50
FG 629/C34	80	26,50
FG 629/C36	80	28,00
FG 629/C40	80	33,00
FG 629/C41	80	33,00
FG 629/C46	80	39,50
FG 629/C50	80	49,50
FG 629/C54	80	51,50
FG 629/C55	80	54,00
FG 629/C58	80	62,00
FG 629/C60	80	67,00
FG 629C/S10	80	299,00
FG 629/L17	80	35,00
FG 629/L19	80	35,00
FG 629/L21	80	35,00
FG 629/L22	80	35,00
FG 629/L24	80	35,00
FG 629/L26	80	33,00
FG 629/L27	80	35,00
FG 629/L30	80	37,00
FG 629/L32	80	37,00
FG 629/L33	80	41,00
FG 629/L34	80	44,50
FG 629/L36	80	47,50
FG 629/L38	80	47,50
FG 629/L41	80	55,00
FG 629/L46	80	65,50
FG 629/L50	80	76,00
FG 629/SN34R	81	70,00
FG 629/AD3	81	15,00
FG 629/AD1	81	29,00
FG 629/AD2	81	33,00
FG 629/AS1	81	5,00
FG 630/B36	75	36,50
FG 630/B41	75	36,50
FG 630/B46	75	41,50
FG 630/B50	75	47,50
FG 630/B55	75	51,50
FG 630/B60	75	60,00
FG 630/B65	75	82,00
FG 630/B70	75	84,50
FG 630/B75	75	98,00
FG 630/B80	75	105,00
FG 630/CR1	75	196,00
FG 630/PR200	76	51,50
FG 630/PR400	76	72,50
FG 630/ES1	76	93,00
FG 630B/S8	76	1.160,00
FG 630/A24	80	36,00
FG 630/A27	80	36,00
FG 630/A30	80	36,00
FG 630/A32	80	37,00
FG 630/A33	80	37,00
FG 630/A34	80	37,00
FG 630/A36	80	37,00
FG 630/A38	80	45,50
FG 630/A41	80	47,50

CODICE	PAGINA	€/Pz
FG 630/A46	80	51,50
FG 630/A50	80	65,50
FG 630/A55	80	70,50
FG 630/A60	80	86,50
FG 630/A65	80	97,00
FG 630/A70	80	110,50
FG 630/A75	80	145,00
FG 630/A80	80	152,50
FG 630A/S14	81	830,00
FG 630/L24	81	61,00
FG 630/L27	81	63,00
FG 630/L30	81	63,00
FG 630/L32	81	64,50
FG 630/L33	81	66,50
FG 630/L34	81	71,50
FG 630/L36	81	71,50
FG 630/L41	81	78,00
FG 630/L46	81	83,00
FG 630/L50	81	93,50
FG 630/L55	81	130,50
FG 630/L60	81	150,50
FG 630/L65	81	171,50
FG 630/L70	81	194,50
FG 630/AD1	81	46,50
FG 630/AS1	81	7,50
FG 630/B65	284	82,00
FG 631/KM4	79	48,50
FG 631/KM5	79	52,50
FG 631/KM6	79	63,00
FG 631/KM7	79	73,50
FG 631/KM8	79	73,50
FG 631/KM9	79	84,00
FG 631/KM10	79	100,00
FG 631/KM11	79	100,00
FG 631/KM12	79	108,50
FG 631/S9	79	766,50
FG 632/KM4	79	47,50
FG 632/KM5	79	50,50
FG 632/KM6	79	60,00
FG 632/KM7	79	68,50
FG 632/KM8	79	73,50
FG 632/KM9	79	84,00
FG 632/KM10	79	94,50
FG 632/KM11	79	94,50
FG 632/KM12	79	100,00
FG 632/S9	79	808,50
FG 710/C	449	150,00
FG 710/D	449	245,00
FG 710/E	449	150,00
FG 710/B	449	120,00
FG 712/L4	306	120,00
FG 712/A	306	50,00
FG 718/2.5T	446	470,00
FG 718/3.5T	447	560,00
FG 719/2T	446	740,00
FG 722/5T	447	1.420,00
FG 725/3T	447	95,00
FG 725/6T	447	160,00
FG 725/12T	447	280,00
FG 735/4T	447	85,00
FG 735/6T	447	98,00
FG 735/10T	447	140,00
FG 735/16T	447	160,00
FG 735/20T	447	200,00
FG 738/1T	447	1.100,00
FG 740/0.5T	448	600,00
FG 745/CMR	445	950,00

CODICE	PAGINA	€/Pz
FG 745/CMF	445	460,00
FG 748/0.5T	448	250,00
FG 750/1P	444	2.600,00
FG 750/2P	444	3.300,00
FG 750/A	448	420,00
FG 752/1P	445	3.400,00
FG 752/2P	445	4.100,00
FG 800/2	202	120,00
FG 800/5	202	120,00
FG 800/3	202	120,00
FG 800/6	202	120,00
FG 800/7	203	120,00
FG 800/8	203	120,00
FG 800/9	203	145,00
FG 139IN1/8	92	1,30
FG 139IN1/6	92	1,60
FG 139IN1/4	92	2,00
FG 139IN3/32	92	1,20
FG 139IN3/16	92	1,60
FG 139IN3/8	92	3,00
FG 139IN5/64	92	1,10
FG 139IN5/32	92	1,50
FG 139IN5/16	92	2,50
FG 139IN7/64	92	1,30
FG 139IN7/32	92	1,80
FG 139IN9/64	92	1,50
FG 1425	322	102,00
FG 1426	322	120,00
FG 1427	322	170,00
FG 1432	323	130,00
FG 1433	323	190,00
FG 1434	322	145,00
FG 1434/V1	323	1,50
FG 1434/V2	323	2,00
FG 1434/V3	323	4,00
FG 1434/V4	323	3,50
FG 1434/V5	323	4,00
FG 1434/V6	323	6,50
FG 1434/V7	323	9,00
FG 1434/EF	323	15,00
FG 1438/S4B	324	680,00
FG 1438/S4C	324	730,00
FG 1440	325	60,00
FG 1440/V1	325	3,00
FG 1440/V2	325	4,00
FG 1445	324	45,00
FG 1445/V1	325	3,00
FG 1445/D	325	5,50
FG 1450	327	132,00
FG 1452	327	140,00
FG 1454	326	180,00
FG 1456	326	230,00
FG 1460	327	150,00
FG 1465	327	200,00
FG 182S16/S4-4	199	25,00
FG 182S16/S4-3	199	28,00
FGA 343N10/KIT	182	20,00
FGA 343N20/KIT	182	20,00
FG 141010	218	320,00
FG 141015	218	90,00
FG 141060-BO	218	11,00
FG 141060-MA	218	13,00
FG 141065	218	32,00
FGA 334AN115/KIT	179	35,00



IL MONDO FASANO TOOLS E' IN CONTINUA EVOLUZIONE

Siamo sempre alla ricerca di nuovi prodotti, sempre più performanti e innovativi, per facilitare il lavoro quotidiano dei professionisti di settore.

RIMANI AGGIORNATO

SEGUICI SUI CANALI SOCIAL



ISCRIVITI ALLA NEWSLETTER

WWW.FASANOTOOLS.COM

A	SEZIONE	PAGINA
Accessori per carrelli porta utensili	15	370
Adattatori per inserti	03	100
Arredamento furgoni	16	416
Assortimenti in modulo di ABS	15	362
Assortimenti in modulo morbido	15	346
Assortimenti per valigie porta-utensili	14	329
Attrezzi bordatubi	13	316
Avviatori/Booster	11	217
Avvitatori ad impulsi	10	170
B	SEZIONE	PAGINA
Banchi da lavoro con cassettiere	15	374
Banchi da lavoro con ripiano in legno	15	376
Banchi da lavoro semplici con ripiano in acciaio	15	372
Banchi da lavoro speciali	15	378
Bauli porta-utensili	14	320
Borse in nylon	14	325
Borse in pelle	14	326
C	SEZIONE	PAGINA
Calibri	09	166
Carrelli porta attrezzi	15	335
Carrello porta utensili mod. FG 100	15	335
Carrello porta utensili mod. FG 101	15	340
Carrello porta utensili mod. FG 102	15	338
Carrello porta utensili mod. FG 104	15	339
Carrello porta utensili mod. FG 105	15	342
Carrelli porta utensili mod. FG 150	15	344
Carrelli porta utensili mod. FG 160	15	345
Cassette porta-utensili a scomparti	14	322
Cassettera porta utensili	15	341
Cavalletti sostegno motore	17	448
Celle torsionometriche	05	131
Cesoie	07	141
Chiavi a bussola e accessori da 1"	02	75
Chiavi a bussola e accessori da 1/2"	02	54
Chiavi a bussola e accessori da 1/4"	02	38
Chiavi a bussola e accessori da 3/4"	02	73
Chiavi a bussola e accessori da 3/8"	02	46
Chiavi a bussola e accessori impact da 1"	02	80
Chiavi a bussola e accessori impact da 1/2"	02	77
Chiavi a bussola e accessori impact da 1/4"	02	81
Chiavi a bussola e accessori impact da 3/4"	02	80
Chiavi a bussola e accessori impact da 3/8"	02	81
Chiavi a bussola e accessori isolati da 1/2"	04	113
Chiavi a bussola e accessori isolati da 3/8"	04	114
Chiavi a cricchetto	01	34
Chiavi a forchetta	01	24
Chiavi a percussione	01	33
Chiavi a pipa	01	28
Chiavi a settore	01	32
Chiavi a T maschio	01	32
Chiavi a T snodate e semplici	01	30
Chiavi a tubo	01	28
Chiavi combinate	01	22

Chiavi di manovra isolate	04	112
Chiavi dinamometriche a disinnesto	05	128
Chiavi dinamometriche ad innesto e accessori	05	130
Chiavi dinamometriche digitali	05	128
Chiavi dinamometriche pre-tarate	05	131
Chiavi maschio a L	03	90
Chiavi maschio con impugnatura	03	97
Chiavi per raccordi	01	27
Chiavi poligonali doppie	01	27
Chiavi regolabili a rullino	13	317
Colonnette di sostegno veicolo	17	447
Comparatori	09	167
Contafiletti	09	166
Cricchetti pneumatici	10	173
Curvatubi	13	317
Cutter e forbici	07	140
E	SEZIONE	PAGINA
Espansori	08	159
Estrattore speciali per cambi automatici	11	271
Estrattori a 2 griffe	08	154
Estrattori a 3 griffe	08	155
Estrattori ad espansione e accessori	08	159
Estrattori per viti e prigionieri	08	160
Estrattori speciali Automotive	11	195
Estrazione cuscinetti e Silent-block	11	213
F	SEZIONE	PAGINA
Flessometri	09	164
G	SEZIONE	PAGINA
Ganci porta utensili	16	391
Giratubi	13	316
Giravite e inserti a percussione	03	101
Giraviti a bussola	03	89
Giraviti angolari	03	87
Giraviti cercafase/prova circuiti	04	117
Giraviti con testa esagonale	03	86
Giraviti dinamometrici	05	131
Giraviti isolati 1000V	04	116
Giraviti per elettronica	04	122
Giraviti per viti ad intaglio e a croce	03	84
Giraviti per viti con testa Tamper Reistant Torx	03	88
Giraviti per viti con testa Torx	03	87
Goniometri	05	129
Griglie porta utensili	15	377
Gru idrauliche	17	447
I	SEZIONE	PAGINA
Innesti rapidi e raccordi	10	183
Inserti con attacco 1/4"	03	95
Inserti con attacco 10mm	03	99
L	SEZIONE	PAGINA
Lampade per controllo colore	12	313
Lampade portatili a led	12	307

Lettoni sotto macchina	17	449
Leve, raschietti e spatole	12	301
Levigatrici	10	180
Livelle	09	165
M	SEZIONE	PAGINA
Martelli per meccanici	06	134
Mazzette	06	134
Mazzuole anti-rimbalzo	06	135
Micrometri	09	167
Moltiplicatori di forza	05	131
Morse	12	302
O	SEZIONE	PAGINA
Oliatori	12	300
P	SEZIONE	PAGINA
Pinze a becchi lunghi e lunghissimi	03	94
Pinze autobloccanti serie Light	03	96
Pinze autobloccanti serie pesante	03	96
Pinze con manici in PVC	03	93
Pinze con sistema Soft-Run	03	92
Pinze e tronchesi con manici isolati	04	106
Pinze per anelli elastici	03	95
Pinze per capicorda e accessori	04	108
Pinze per elettronica	04	124
Pinze regolabili	03	106
Pinze speciali Automotive	11	214
Pinze taglia e spellafili	04	118
Pinzette di precisione	04	123
Pistole per colla a caldo	12	301
Pistole per grasso e silicone	12	300
Prolunghe magnetiche e specchietti	12	304
Punzoni, cacciaspina e bulini	12	304
R	SEZIONE	PAGINA
Raccordi speciali per olio cambi automatici	11	266
Rivettatrici	12	303
Rivettatrici pneumatiche	10	177
S	SEZIONE	PAGINA
Saldatori	12	305
Scalpelli e bedani	06	135
Scalpelli e punte per edilizia	06	136
Seggiolini	17	449
Seghetti	07	142
Separatori	08	159
Set di utensili in modulo di ABS	15	362
Set di utensili in modulo morbido	15	346
Smerigliatrici pneumatiche	10	178
Smonta ammortizzatori	17	444
Sollevatori a carrello	17	446
Sollevatori idraulici a bottiglia	17	447
Sollevatore idraulico da fossa e sottofossa	17	448

Spaccadadi	08	161
Spazzole	12	303
Spellacavi	04	117
Spellafili	04	118
Squadre	09	165
T	SEZIONE	PAGINA
Tagliacavi	04	119
Tagliatubi	07	141
Termometri digitali	09	167
Tester digitali Automotive	11	219
Tiranti	08	159
Troncabulloni	07	142
Tubi per aria compressa	10	183
U	SEZIONE	PAGINA
Utensili a batteria	11	211
Utensili da taglio isolati	04	118
Utensili per candele e candele	11	199
Utensili per alternatori	11	204
Utensili per centraggio frizioni	11	205
Utensili per fasatura motore	11	222
Utensili per filettare	07	143
Utensili per filtri e tappi olio	11	188
Utensili per mozzi ruote	02	67
Utensili per settore carrozzeria	11	273
Utensili per settore gommisti	11	206
Utensili per settore truck	11	283
Utensili per tagliare e forare	07	146
Utensili per travaso e inserimento liquidi	11	193
Utensili speciali per elettro-iniettori Diesel	11	195
V	SEZIONE	PAGINA
Valigie porta-utensili in ABS e polipropilene	14	322



Fasangas S.r.l.
Viale Grecia, 3 - 73100 Zona Ind.le Lecce (Le) - ITALY
Tel.: [+39].0832.362097/364265
Cod. Fisc. e P.IVA: 03496900758
Capitale Sociale: 465.000,00 euro
REA C.C.I.A.A. Lecce N.225553
Azienda certificata ISO 9001:2015

info@fasanotools.com
www.fasanotools.com

CONDIZIONI GENERALI DI VENDITA

1) ORDINI

Le ordinazioni sono assunte alle condizioni che seguono e che si intendono accettate dall'acquirente con il conferimento dell'ordine. Eventuali deroghe dovranno essere concordate dalle parti per iscritto e limitatamente alle vendite cui fanno riferimento.

Gli ordini sono irrevocabili da parte dell'acquirente, senza possibilità di ulteriori aggiunte. Fasangas Srl può accettare l'ordine inviato dall'acquirente mediante spedizione della merce, anche a più riprese, in conformità all'art. 1327 c.c.

2) CARATTERISTICHE DEI PRODOTTI

I pesi, le dimensioni, i prezzi, le confezioni, i colori e gli altri dati figuranti nei cataloghi, prospetti, circolari ed altri documenti illustrativi del venditore hanno carattere di indicazione approssimativa.

Fasangas Srl si riserva di variare, in qualsiasi momento e senza preavviso, i dati tecnici e costruttivi dei suoi prodotti.

3) PREZZI

I prezzi si intendono sempre al netto di IVA, di eventuali imposte o tasse, nonché di tributi, diritti ed oneri fiscali o di qualsiasi specie eventualmente gravanti sul contratto. Essi si riferiscono a merce franco magazzino di Fasangas Srl.

I prezzi convenuti sono calcolati in base al listino in vigore al momento dell'ordine. Fasangas Srl si riserva il diritto di modificare i prezzi senza preavviso.

4) PAGAMENTI

Salvo contrario patto scritto, il pagamento deve essere effettuato per contanti, direttamente a favore di Fasangas S.r.l., presso la sede del venditore e nei termini indicati nella fattura.

In caso di ritardato pagamento, l'acquirente sarà tenuto a corrispondere a Fasangas Srl gli interessi di mora di cui al D.Lgs. 231/02 e produrrà la perdita per il compratore del beneficio del termine ai sensi dell'art. 1186 c.c., rendendo immediatamente esigibili eventuali somme non ancora scadute.

5) SPEDIZIONI

La spedizione è a carico del compratore. La merce viaggia sempre per conto e a rischio e pericolo del compratore, al più tardi, dal momento della consegna al vettore. Pertanto, Fasangas Srl non è responsabile di deterioramenti, avarie, ritardi, multe o altri pregiudizi e danni di qualsiasi specie che possano intervenire durante il trasporto. Spetta all'acquirente effettuare le verifiche opportune della merce ed inoltrare reclami nei confronti del trasportatore.

Le spedizioni verranno appoggiate al corriere prescritto dal cliente o, in mancanza di questo, al corriere più economico di conoscenza di Fasangas Srl

6) TERMINI DI CONSEGNA

I termini di consegna della merce, comunque e dovunque previsti, hanno puro valore indicativo e non vincolano il venditore. L'acquirente, tuttavia, ha la facoltà di recedere, per iscritto, qualora la consegna non sia intervenuta entro sei mesi dalla data pattuita; oltre a tale facoltà di recesso, nessun'altra pretesa, nemmeno risarcitoria, potrà essere avanzata dall'acquirente. Non si considera imputabile a Fasangas Srl l'eventuale ritardo dovuto a causa di forza maggiore o ad atti od omissioni del compratore.

7) GARANZIA

La garanzia copre i vizi o difetti di fabbricazione ed è limitata alla sostituzione o riparazione dei prodotti riconosciuti difettosi da Fasangas Srl, con esclusione di qualsiasi diritto al risarcimento del danno. E' inteso, pertanto, che la suddetta garanzia comprende e sostituisce ogni garanzia o responsabilità della Fasangas Srl (contrattuale o extracontrattuale) comunque originata dai prodotti forniti. La predetta garanzia non si applica ai prodotti che presentano normale usura, segni di manomissione o di uso improprio. L'accertamento della qualità o dei vizi del prodotto o delle parti sarà effettuato da Fasangas Srl presso il proprio centro di assistenza tecnico o in officine autorizzate. Qualsiasi ritorno di merce deve essere preventivamente autorizzato.

Le spese di trasporto dei prodotti da sostituire o riparare e dei prodotti sostituiti o riparati sono a carico del compratore.

8) RECLAMI

Il compratore deve denunciare, per iscritto mediante lettera raccomandata a/r, gli eventuali vizi o difetti dei prodotti forniti o l'eventuale mancata o difforme fornitura di tutto o parte dell'ordine di acquisto, a pena di decadenza, entro otto giorni da calcolarsi rispettivamente dalla data di consegna dei prodotti (vizi apparenti) e/o da quella della scoperta dei vizi o difetti (vizi occulti).

E' inteso che eventuali reclami o contestazioni non danno diritto all'acquirente di sospendere o comunque ritardare i pagamenti dei prodotti oggetto di contestazione, né, tanto meno, di altre forniture.

La garanzia non opera nel caso in cui l'acquirente abbia eseguito o fatto eseguire interventi da parte di terzi sui prodotti.

9) RESI

Eventuali resi di merce vengono accettati solo se preventivamente concordati e autorizzati per iscritto, contrariamente saranno respediti al mittente con trasporto a carico dell'acquirente.

10) RISOLUZIONE DEL CONTRATTO

L'insolvenza del compratore, ancorché non accertata giudizialmente, e l'inadempimento anche di una sola delle obbligazioni a lui derivanti dal contratto di vendita, determinano la risoluzione ipso iure dell'accordo, con conseguente diritto di Fasangas Srl all'integrale risarcimento del danno e con la facoltà di Fasangas Srl di pretendere la restituzione dei prodotti forniti.

11) FORO COMPETENTE

Per ogni controversia derivante dal contratto o ad esso collegato sarà esclusivamente competente il Foro di Lecce.



FASANGAS S.r.l.

Viale Grecia 3, lotto 18 Zona Industriale 73100
LECCE (LE) ITALY (+39) 0832.352097/364265
info@fasanotools.com



FASANOTOOLS.COM



8 053853 743251